

SR

(HSR) ESTACIONARIA 1 / STATIONARY 1 / STATIONAIRE 1 / STATIONÄR 1 / СТАЦИОНАРНОЕ СОСТОЯНИЕ / ثابتة

▽△	H(m)	☒	▣
60 - 30	53,1	9	-

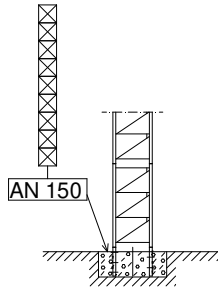

(HSR) ESTACIONARIA 3 / STATIONARY 3 / STATIONAIRE 3 / STATIONÄR 3 / СТАЦИОНАРНОЕ СОСТОЯНИЕ / ثابتة

▽△	H(m)	☒	▣
60 - 30	59,7	9	-

▽△	H(m)	☒	▣
60 - 30	45,5	7	1

▽△	H(m)	☒	▣
60 - 55	54,5	9	-

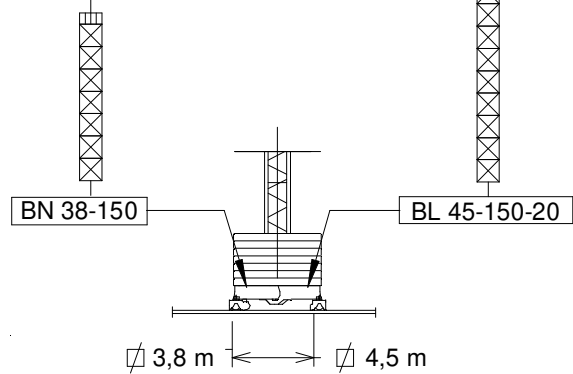
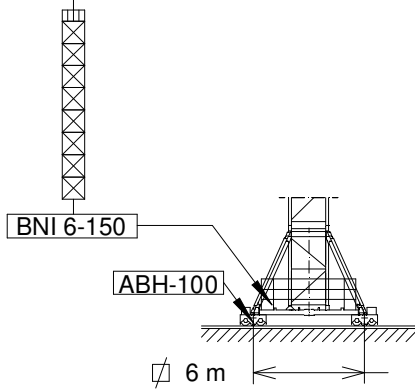

(HSR) TRASLACION / TRAVELLING / TRASLATION / FORTBEWEGUNG / ПЕРЕМЕЩЕНИЕ / متحركة

▽△	H(m)	☒	▣
60 - 30	60,0	9	-

▽△	H(m)	☒	▣
60 - 30	45,7	7	1

▽△	H(m)	☒	▣
60 - 55	54,7	9	-

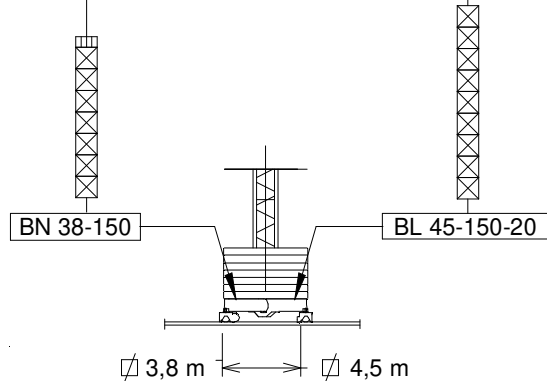
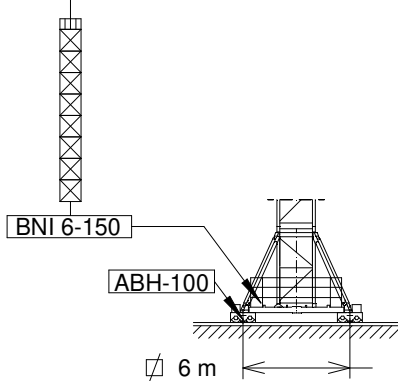

▣ T3-150

☒ T6-150
TD6-150

☒ T12-150

$H_{SR/DR} = H_{SR} - 0,5$



HSR = Altura máxima bajo gancho sin arriostrar (m) / Maximum height under hook without fastening (m) / Hauteur maximale sous crochet sans ancrage (m)
Max. Hakenhöhe ohne Verstreben (m) / Максимальная высота под крюком без крепления (m) / أقصى ارتفاع تحت الخطاف بدون ربط (m)



BNI 6-150 161.20.000
BN 38-150 161.20.800

BL 45-150-20 171.20.200

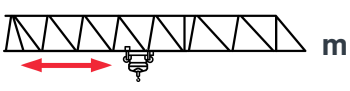
AN 150 161.21.000
ABH 100 201.23.000

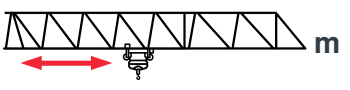

 SR - 4 t										 EXTRA Lift
 4 t @...(m)	30	35	40	45	50	55	60			
60	29,8	3,97	3,34	2,86	2,49	2,19	1,95	1,75		
	32,2	4,0	3,64	3,12	2,72	2,4	2,14	1,92	+	
55	33,5	4,0	3,8	3,27	2,85	2,52	2,25	—		
	36,2	4,0	4,0	3,57	3,12	2,76	2,46	—	+	
50	37,1	4,0	4,0	3,68	3,22	2,85	—	—		
	40,1	4,0	4,0	4,0	3,51	3,11	—	—	+	
45	40,5	4,0	4,0	4,0	3,55	—	—	—		
	43,8	4,0	4,0	4,0	3,86	—	—	—	+	
40	40,0	4,0	4,0	4,0	—	—	—	—		
	40,0	4,0	4,0	4,0	—	—	—	—	+	
35	35,0	4,0	4,0	—	—	—	—	—		
	35,0	4,0	4,0	—	—	—	—	—	+	
30	30,0	4,0	—	—	—	—	—	—		
	30,0	4,0	—	—	—	—	—	—	+	

 SR / DR - 4 / 8 t											 EXTRA Lift
 4 - 8 t @...(m)	20	25	30	35	40	45	50	55	60		
60	28,9 - 15,5	4,0 - 6,06	4,0 - 4,72	3,83	3,19	2,72	2,34	2,05	1,8	1,6	
	30,3 - 16,1	4,0 - 6,34	4,0 - 4,96	4,0 - 4,05	3,39	2,9	2,52	2,22	1,97	1,76	+
55	32,4 - 17,4	4,0 - 6,88	4,0 - 5,38	4,0 - 4,38	3,66	3,12	2,71	2,37	2,1	—	
	34,2 - 18,1	4,0 - 7,19	4,0 - 5,66	4,0 - 4,64	3,9	3,36	2,93	2,59	2,31	—	+
50	36,0 - 19,3	4,0 - 7,7	4,0 - 6,03	4,0 - 4,92	4,0 - 4,13	3,53	3,07	2,7	—	—	
	38,2 - 20,1	4,0 - 8,0	4,0 - 6,35	4,0 - 5,22	4,0 - 4,41	3,81	3,34	2,96	—	—	+
45	39,2 - 21,0	4,0 - 8,0	4,0 - 6,62	4,0 - 5,42	4,0 - 4,55	3,9	3,4	—	—	—	
	41,9 - 21,9	4,0 - 8,0	4,0 - 6,96	4,0 - 5,74	4,0 - 4,86	4,0 - 4,21	3,7	—	—	—	+
40	40,0 - 21,5	4,0 - 8,0	4,0 - 6,78	4,0 - 5,54	4,0 - 4,66	4,0	—	—	—	—	
	40,0 - 22,3	4,0 - 8,0	4,0 - 7,10	4,0 - 5,85	4,0 - 4,97	4,0 - 4,3	—	—	—	—	+
35	35,0 - 21,6	4,0 - 8,0	4,0 - 6,83	4,0 - 5,59	4,0 - 4,7	—	—	—	—	—	
	35,0 - 22,5	4,0 - 8,0	4,0 - 7,16	4,0 - 5,91	4,0 - 5,01	—	—	—	—	—	+
30	30,0 - 21,7	4,0 - 8,0	4,0 - 6,85	4,0 - 5,6	—	—	—	—	—	—	
	30,0 - 22,5	4,0 - 8,0	4,0 - 7,16	4,0 - 5,91	—	—	—	—	—	—	+

Datos válidos para / Valid data for
 Données valables pour / Gultige Daten für / Допустимые данные для / البيانات الصالحة ل



H ≤ 50 m



EC3366VF
24,3 kW

***EC60180VF**
45 kW

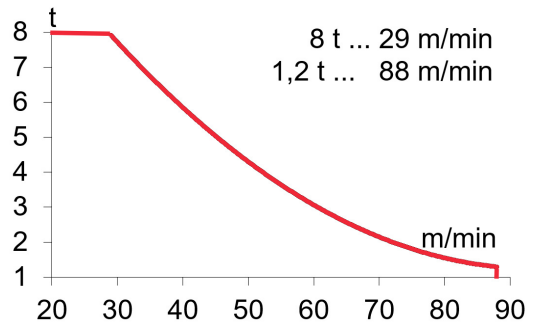
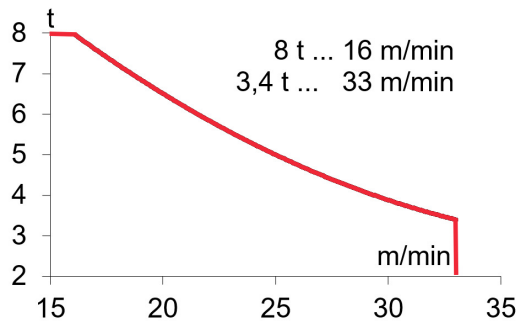
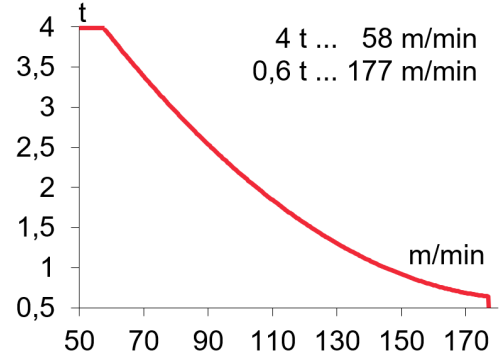
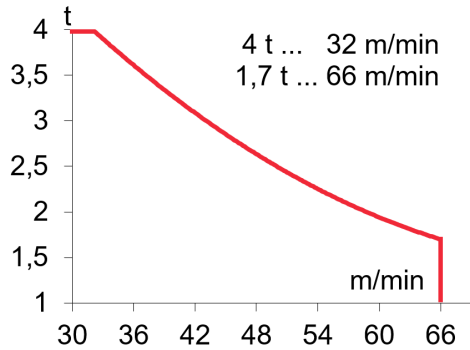

H ≤ SR 208 m
DR 104 m



584 m

H ≤ SR 352 m
DR 176 m



967 m

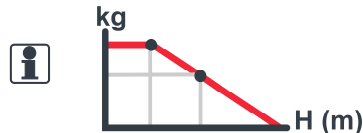

OG1508VF
2 x 5,5 kW



TC460VF
3 kW

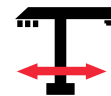

TG2020VF
2 x 7,3 kW



0...0,8
r/min
sl/min

4 t 0...60 m/min
8 t 0...30 m/min

0...20
m/min

3~ 400V 50Hz
480V 60Hz

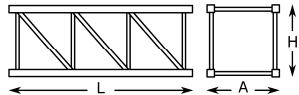
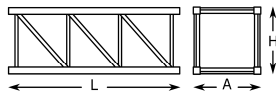
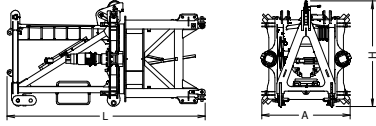
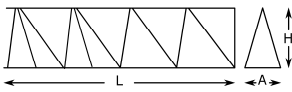
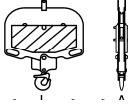
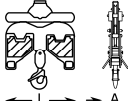
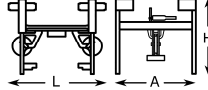
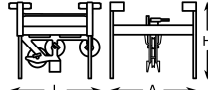
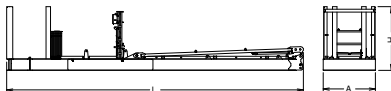
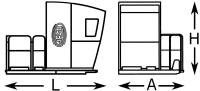
KVA			
EC3366VF	31	38	45
EC60180VF	43	56	69

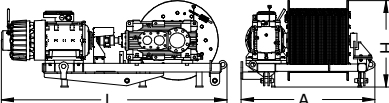
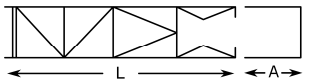
		L (m)	A (m)	H (m)	P/W(kg)	
Torre inferior / Lower tower Tour inférieure / Unterer Turm Нижняя башня / البرج السفلي	TI-6-150		6,175	2,190	2,190	3535
Torre / Tower Tour / Turm / Башня / برج	T6-150 TD6-150 T3-150 T12-150		6,175 6,175 3,265 12,000	1,870 1,870 1,870 1,870	1,870 1,870 1,870 1,870	2760 2930 1550 5180
Torre asiento pista + punta de torre + orientación Slewing table + tower head + slewing mechanism Tour pivot + porte-flèche + mécanisme d'orientation Turmsitz + Turmspitze + Ausrichtung / Сиденье площадки + верхней секции башни + поворотный механизм / برج وحدة الدوارن رأس البرج + آلية الدوران			4,342	2,090	2,370	6000
Tramo de pluma Jib section Tronçon de flèche Auslegerabschnitt Секция стрелы أجزاء الذراع	P20-01 P20-02+tr P20-03 P15-04 P15-05 P15-06 P15-07 PP15-1		10,282 10,270 10,235 10,132 10,190 5,185 5,179 0,878	1,266 1,212 1,126 1,126 1,126 1,126 1,126 1,291	2,250 2,195 2,191 1,675 1,665 1,663 1,657 1,963	2060 1865 1315 820 605 295 220 130
Polipasto / Hook assembly Palan / Flaschenzug Полиспаст / بكرة	SR - 4 t		0,904	0,200	1,016	170
	SR / DR - 8 t		0,955	0,354	1,215	282
Carro / Trolley Chariot / Laufkatze Грузовая тележка / عرب	SR - 4 t		1,540	1,956	1,896	305
	SR / DR - 8 t		1,539	1,959	1,896	355
Contrapluma / Counterjib / Contre-flèche Gegenausleger / Противовесная консоль / الذراع المعاكس			12,157	2,670	1,970	4160
Plataforma y cabina / Platform and cabin Plateforme et cabine / Plattform + Führerstand Платформа и кабина / منصة وكابينة			3,520	2,060	2,400	1120
Armario eléctrico y plataforma Electrical cabinet and platform / Armoire électrique et plateforme / Stromkasten + Plattform / الخزانة الكهربائية والمنصة			2,752	1,311	2,190	1000
Soporte y elevación (sin cable) / Support and hoisting (without rope) Support et levage (sans câble) / Stützung und Hebewerk (ohne Seil) / Опора и подъем (без троса) م ورفع (بدون كابل)			2,449	1,452	0,965	1700
Estructura torre de montaje / Jacking cage structure Structure de tour de montage / Konstruktion des Montageturms / Структура монтажной башни			10,320	2,420	2,310	3500

COMPOSICIONES DE TORRE / TOWER COMPOSITIONS

COMPOSITIONS DE LA TOUR / TURMZUSAMMENSETZUNGEN / КОНСТРУКЦИЯ БАШНИ / مكونات البرج

J165.8

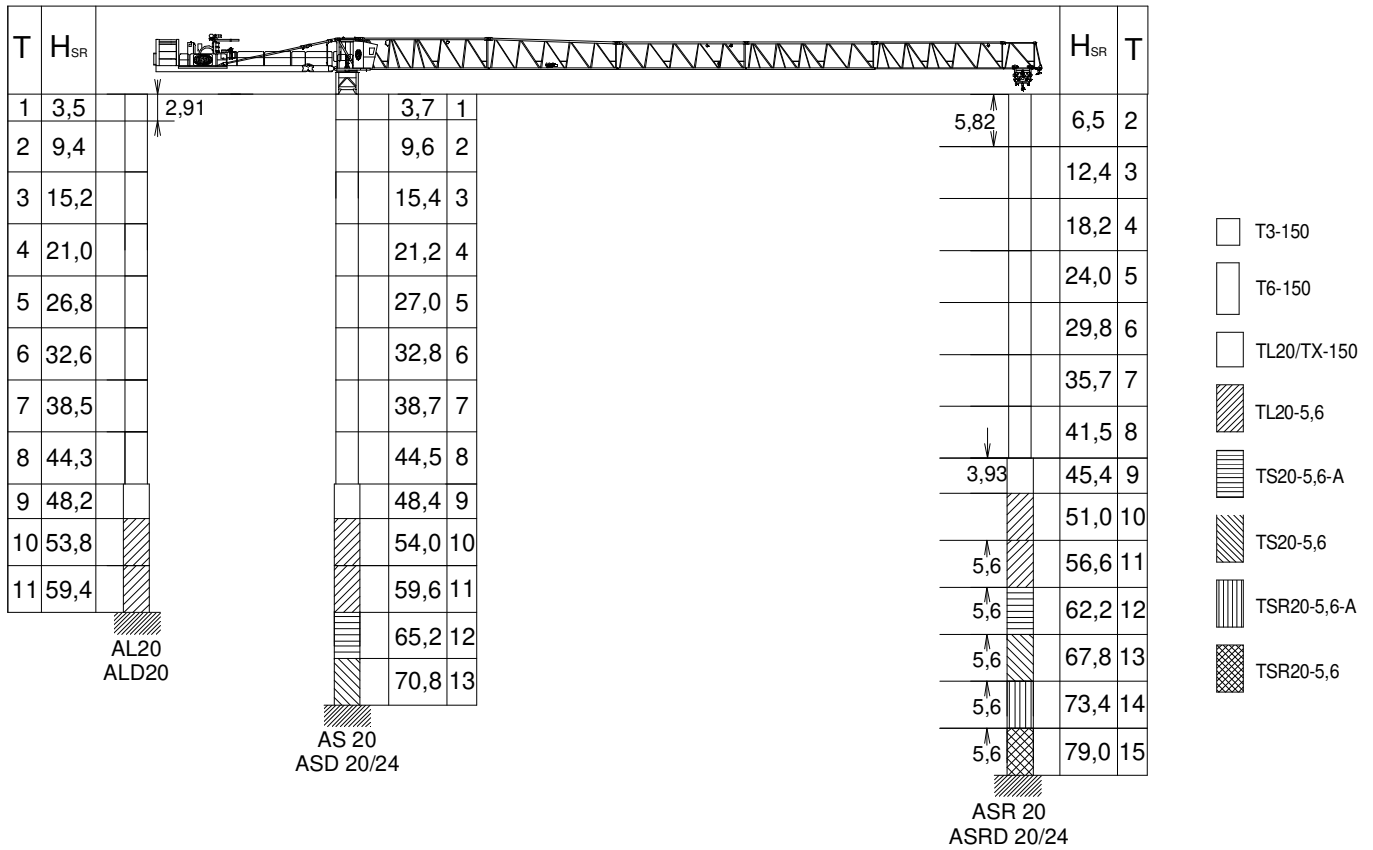

T: Torre / Tower / Tour / Turm / Башни / أبراج
H: Altura / Height / Hauteur / Höhe / Высота / ارتفاع

$$H_{SR/DR} = H_{SR} - 0,5$$

TL20/TX-150.....	161.36.000
TL20-5,6.....	204.31.400
TS20-5,6A.....	204.31.500
TS20-5,6.....	204.31.200
TSR20-5,6A.....	206.31.300
TSR20-5,6.....	206.31.000

AL 20.....	153.21.800
ALD 20.....	160.21.250
AS 20.....	160.21.010
ASD 20/24.....	160.21.080
ASR 20.....	160.21.200
ASRD 20/24.....	156.21.000

Otras configuraciones de torre / Other tower configuration / Autres configurations / Andere turmkonfigurationen / Прочие конфигурации / مكونات أخرى

TRANSPORTE / TRANSPORT / TRANSPORT / TRANSPORT / ТРАНСПОРТИРОВКА / نقل

J165.8



Viento fuera de servicio / Out of service wind / Vitesse du vent hors service / Wind außer betrieb / Ветровая нагрузка в покое / الريح خارج الخدمة

Consultar / Consult / Nous consulter / Anfragen / Консультируйтесь / الرجوع إلى

En servicio / In service / En service / In betrieb / В работе / الخدمة

Fuera de servicio / Out of service / Hors service / Außer betrieb / В покое / خارج الخدمة

Opcional / Optional / En option / Optional / Опция / اختياري



Ctra./ Rd. Madrid – Irún - Km. 415 - 20213 IDIAZABAL (Gipuzkoa) - ESPAÑA / SPAIN
P.O. Box, 23 - 20.200 - BEASAIN - E-mail: jaso@jaso.com
Tel. +34 943 - 18 70 00 • Fax. +34 943 - 18 70 20
www.jaso.com

05/02/2025

FEM 1001

DELEGACIÓN / DEALER

Reservado el derecho a modificaciones sin previo aviso. Declinamos toda responsabilidad derivada de la información proporcionada / Subject to modification, without prior notice. This information is supplied without liability / L'entreprise se réserve le droit de procéder à des modifications sans préavis. Nous déclinons toute responsabilité quant aux informations fournies / Das Recht auf Änderungen ohne vorherige Ankündigung bleibt vorbehalten. Wir übernehmen keine Gewähr für die gemachten Angaben / Мы оставляем за собой право на внесение изменений без предварительного уведомления. Мы снимаем с себя любую ответственность в отношении предоставленной информации / حقوق التغيير محفوظة / دون إشعار مسبق. دون أدنى مسؤولية عن المعلومات المقدمة