

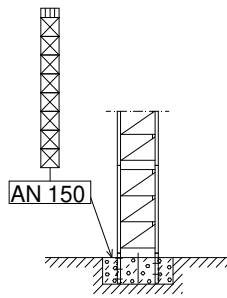

SR

(H<sub>SR</sub>) ESTACIONARIA 1 / STATIONARY 1 / STATIONAIRE 1 / STATIONÄR 1 / СТАЦИОНАРНОЕ СОСТОЯНИЕ / ثابتة

▽△	H(m)	☒	☒
60	47,2	8	-
55 - 30	50,1	8	1



(H<sub>SR</sub>) ESTACIONARIA 3 / STATIONARY 3 / STATIONAIRE 3 / STATIONÄR 3 / СТАЦИОНАРНОЕ СОСТОЯНИЕ / ثابتة

▽△	H(m)	☒	☒
60	53,9	8	-
55 - 30	56,8	8	1

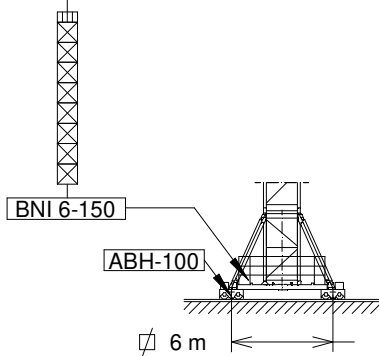

▽△	H(m)	☒	☒
60 - 30	42,6	7	-

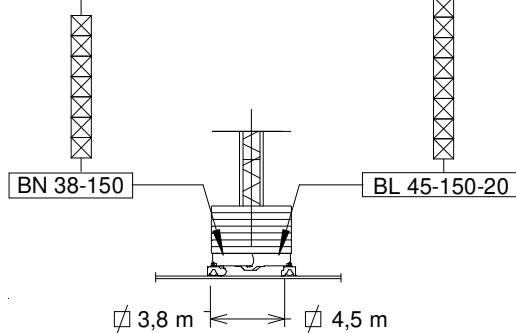

▽△	H(m)	☒	☒
60	48,7	8	-
55 - 30	51,6	8	1

(H<sub>SR</sub>) TRASLACIÓN / TRAVELLING / TRASLATION / FORTBEWEGUNG / ПЕРЕМЕЩЕНИЕ / متحركة

▽△	H(m)	☒	☒
60	54,2	8	-
55 - 30	57,1	8	1

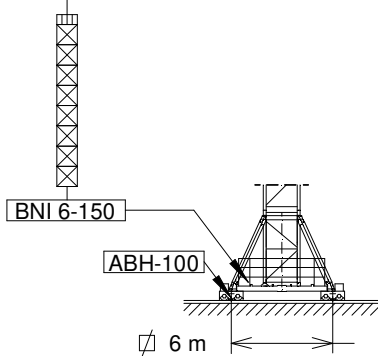

▽△	H(m)	☒	☒
60 - 30	42,8	7	-

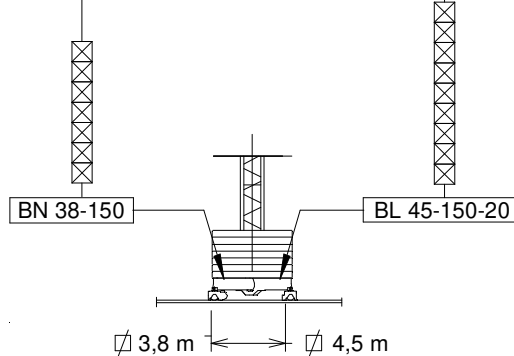

▽△	H(m)	☒	☒
60	48,9	8	-
55 - 30	51,8	8	1

- ☒ T3-150
- ☒ T6-150  
TD6-150
- ☒ T12-150

**H<sub>SR</sub>/DR = H<sub>SR</sub>-0,5**

H<sub>SR</sub> = Altura máxima bajo gancho sin arriostrar (m) / Maximum height under hook without fastening (m) / Hauteur maximale sous crochet sans ancrage (m)  
 Max. Hakenhöhe ohne Verstreben (m) / Максимальная высота под крюком без крепления (m) / أقصى ارتفاع تحت الخطاف بدون ربط



BNI 6-150 .....	161.20.000
BN 38-150 .....	161.20.800



BL 45-150-20 .....	171.20.200
--------------------	------------

AN 150 .....	161.21.000
ABH 100.....	201.23.000

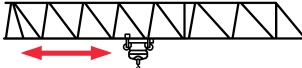

Reservado el derecho a modificaciones sin previo aviso. Declinamos toda responsabilidad derivada de la información proporcionada / Subject to modification, without prior notice. This information is supplied without liability / L'entreprise se réserve le droit de procéder à des modifications sans préavis. Nous déclinons toute responsabilité quant aux informations fournies / Das Recht auf Änderungen ohne vorherige Ankündigung bleibt vorbehalten. Wir übernehmen keine Gewähr für die gemachten Angaben / Мы оставляем за собой право на внесение изменений без предварительного уведомления. Мы снимаем с себя любую ответственность в отношении предоставленной информации / حقوق التغيير محفوظة دون إشعار مسبق دون أدنى مسؤولية عن المعلومات المقدمة

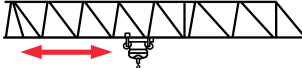
 <b>SR - 4 t</b>		 m								 EXTRA Lift
	4 t @...(m)	30	35	40	45	50	55	60		
60	29,8	3,97	3,34	2,86	2,49	2,19	1,95	1,75		
	32,2	4,0	3,64	3,12	2,72	2,4	2,14	1,92	+	
55	33,5	4,0	3,8	3,27	2,85	2,52	2,25	—		
	36,2	4,0	4,0	3,57	3,12	2,76	2,46	—	+	
50	37,1	4,0	4,0	3,68	3,22	2,85	—	—		
	40,1	4,0	4,0	4,0	3,51	3,11	—	—	+	
45	40,5	4,0	4,0	4,0	3,55	—	—	—		
	43,8	4,0	4,0	4,0	3,86	—	—	—	+	
40	40,0	4,0	4,0	4,0	—	—	—	—		
	40,0	4,0	4,0	4,0	—	—	—	—	+	
35	35,0	4,0	4,0	—	—	—	—	—		
	35,0	4,0	4,0	—	—	—	—	—	+	
30	30,0	4,0	—	—	—	—	—	—		
	30,0	4,0	—	—	—	—	—	—	+	

 <b>SR / DR - 4 / 8 t</b>		 m										 EXTRA Lift
	4 - 8 t @...(m)	20	25	30	35	40	45	50	55	60		
60	28,9 - 15,5	4,0 - 6,06	4,0 - 4,72	3,83	3,19	2,72	2,34	2,05	1,8	1,6		
	30,3 - 16,1	4,0 - 6,34	4,0 - 4,96	4,0 - 4,05	3,39	2,9	2,52	2,22	1,97	1,76	+	
55	32,4 - 17,4	4,0 - 6,88	4,0 - 5,38	4,0 - 4,38	3,66	3,12	2,71	2,37	2,1	—		
	34,2 - 18,1	4,0 - 7,19	4,0 - 5,66	4,0 - 4,64	3,9	3,36	2,93	2,59	2,31	—	+	
50	36,0 - 19,3	4,0 - 7,7	4,0 - 6,03	4,0 - 4,92	4,0 - 4,13	3,53	3,07	2,7	—	—		
	38,2 - 20,1	4,0 - 8,0	4,0 - 6,35	4,0 - 5,22	4,0 - 4,41	3,81	3,34	2,96	—	—	+	
45	39,2 - 21,0	4,0 - 8,0	4,0 - 6,62	4,0 - 5,42	4,0 - 4,55	3,9	3,4	—	—	—		
	41,9 - 21,9	4,0 - 8,0	4,0 - 6,96	4,0 - 5,74	4,0 - 4,86	4,0 - 4,21	3,7	—	—	—	+	
40	40,0 - 21,5	4,0 - 8,0	4,0 - 6,78	4,0 - 5,54	4,0 - 4,66	4,0	—	—	—	—		
	40,0 - 22,3	4,0 - 8,0	4,0 - 7,10	4,0 - 5,85	4,0 - 4,97	4,0 - 4,3	—	—	—	—	+	
35	35,0 - 21,6	4,0 - 8,0	4,0 - 6,83	4,0 - 5,59	4,0 - 4,7	—	—	—	—	—		
	35,0 - 22,5	4,0 - 8,0	4,0 - 7,16	4,0 - 5,91	4,0 - 5,01	—	—	—	—	—	+	
30	30,0 - 21,7	4,0 - 8,0	4,0 - 6,85	4,0 - 5,6	—	—	—	—	—	—		
	30,0 - 22,5	4,0 - 8,0	4,0 - 7,16	4,0 - 5,91	—	—	—	—	—	—	+	

Datos válidos para / Valid data for

Donnees valables pour / Gultige Daten für / Допустимые данные для / البيانات الصالحة ل



H ≤ 50 m



FEM 1005 - C25





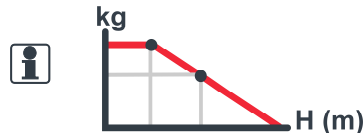

EC3366VF 24,3 kW		*EC60180VF 45 kW		
	<p>4 t ... 32 m/min 1,7 t ... 66 m/min</p>		<p>4 t ... 58 m/min 0,6 t ... 177 m/min</p>	
	<p>8 t ... 16 m/min 3,4 t ... 33 m/min</p>		<p>8 t ... 29 m/min 1,2 t ... 88 m/min</p>	
	<p>H ≤ SR 208 m DR 104 m</p>	584 m	<p>H ≤ SR 352 m DR 176 m</p>	967 m



	OG1508VF 2 x 5,5 kW		TC460VF 3 kW		TG2020VF 2 x 7,3 kW
0...0,8 r/min sl/min		4 t 0...60 m/min 8 t 0...30 m/min		0...20 m/min	

3~ 400V 50Hz  
480V 60Hz

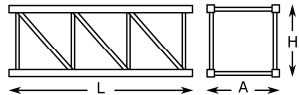
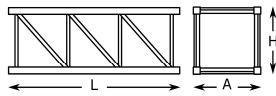
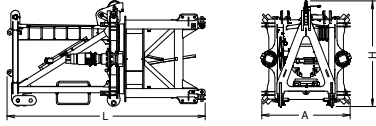
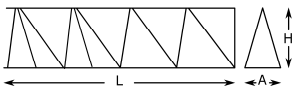
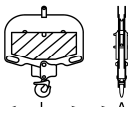
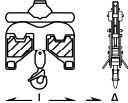
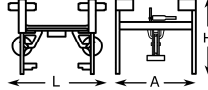
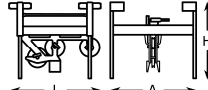
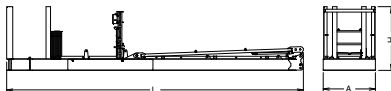
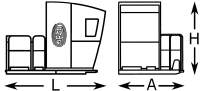
KVA			
EC3366VF	31	38	45
EC60180VF	43	56	69

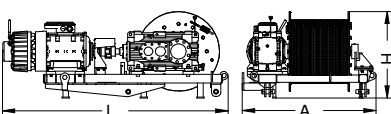
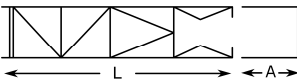
		L (m)	A (m)	H (m)	P/W(kg)	
<b>Torre inferior / Lower tower</b> Tour inférieure / Unterer Turm Нижняя башня / البرج السفلي	TI-6-150		6,175	2,190	2,190	3535
<b>Torre / Tower</b> Tour / Turm / Башня / برج	T6-150 TD6-150 T3-150 T12-150		6,175 6,175 3,265 12,000	1,870 1,870 1,870 1,870	1,870 1,870 1,870 1,870	2760 2930 1550 5180
<b>Torre asiento pista + punta de torre + orientación</b> <b>Slewing table + tower head + slewing mechanism</b> Tour pivot + porte-flèche + mécanisme d'orientation Turmsitz + Turmspitze + Ausrichtung / Сиденье площадки + верхней секции башни + поворотный механизм / برج وحدة الدوارن رأس البرج + آلية الدوران			4,342	2,090	2,370	6000
<b>Tramo de pluma</b> <b>Jib section</b> Tronçon de flèche Auslegerabschnitt Секция стрелы أجزاء الذراع	P20-01 P20-02+tr P20-03 P15-04 P15-05 P15-06 P15-07 PP15-1		10,282 10,270 10,235 10,132 10,190 5,185 5,179 0,878	1,266 1,212 1,126 1,126 1,126 1,126 1,126 1,291	2,250 2,195 2,191 1,675 1,665 1,663 1,657 1,963	2060 1865 1315 820 605 295 220 130
<b>Polipasto / Hook assembly</b> Palan / Flaschenzug Полиспаст / بكرة	SR - 4 t		0,904	0,200	1,016	170
	SR / DR - 8 t		0,955	0,354	1,215	282
<b>Carro / Trolley</b> Chariot / Laufkatze Грузовая тележка / عرب	SR - 4 t		1,540	1,956	1,896	305
	SR / DR - 8 t		1,539	1,959	1,896	355
<b>Contrapluma / Counterjib / Contre-flèche</b> Gegenausleger / Противовесная консоль / الذراع المعاكس			12,157	2,670	1,970	4160
<b>Plataforma y cabina / Platform and cabin</b> Plateforme et cabine / Plattform + Führerstand Платформа и кабина / منصة وكابينة			3,520	2,060	2,400	1120
<b>Armario eléctrico y plataforma</b> Electrical cabinet and platform / Armoire électrique et plateforme / Stromkasten + Plattform / الخزانة الكهربائية والمنصة			2,752	1,311	2,190	1000
<b>Soporte y elevación (sin cable) / Support and hoisting (without rope)</b> Support et levage (sans câble) bstützung und Hebewerk (ohne Seil) / Опора и подъем (без троса) م ورفع (بدون كابل)			2,449	1,452	0,965	1700
<b>Estructura torre de montaje / Jacking cage structure</b> Structure de tour de montage / Konstruktion des Montageturms / Структура монтажной башни			10,320	2,420	2,310	3500

# COMPOSICIONES DE TORRE / TOWER COMPOSITIONS

COMPOSITIONS DE LA TOUR / TURMZUSAMMENSETZUNGEN / КОНСТРУКЦИЯ БАШНИ / مكونات البرج

J165.8

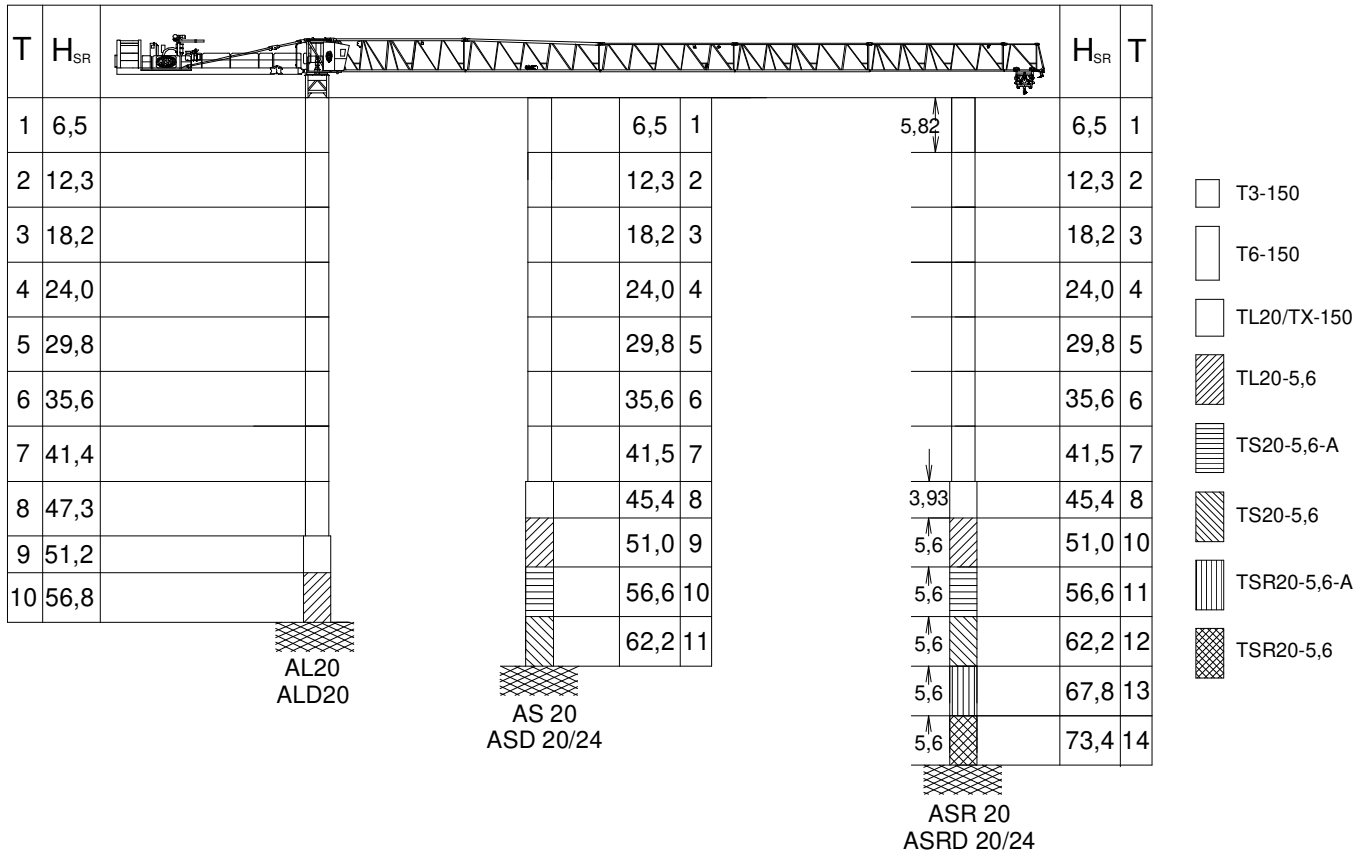

T: Torre / Tower / Tour / Turm / Башни / أبراج  
H: Altura / Height / Hauteur / Höhe / Высота / ارتفاع

$$H_{SR/DR} = H_{SR} - 0,5$$

TL20/TX-150.....	161.36.000
TL20-5,6 .....	204.31.400
TS20-5,6A .....	204.31.500
TS20-5,6.....	204.31.200
TSR20-5,6A.....	206.31.300
TSR20-5,6.....	206.31.000

AL 20.....	153.21.800
ALD 20.....	160.21.250
AS 20 .....	160.21.010
ASD 20/24 .....	160.21.080
ASR 20 .....	160.21.200
ASRD 20/24.....	156.21.000

Otras configuraciones de torre / Other tower configuration / Autres configurations / Andere turmkonfigurationen / Прочие конфигурации / مكونات أخرى

## TRANSPORTE / TRANSPORT / TRANSPORT / TRANSPORT / ТРАНСПОРТИРОВКА / نقل

J165.8



SR/DR +



Viento fuera de servicio / Out of service wind / Vitesse du vent hors service / Wind außer betrieb / Ветровая нагрузка в покое / الريح خارج الخدمة

Consultar / Consult / Nous consulter / Anfragen / Консультируйтесь / الرجوع إلى

En servicio / In service / En service / In betrieb / В работе / في الخدمة

Fuera de servicio / Out of service / Hors service / Außer betrieb / В покое / خارج الخدمة

Opcional / Optional / En option / Optional / Опция / اختياري



Ctra./ Rd. Madrid – Irún - Km. 415 - 20213 IDIAZABAL (Gipuzkoa) - ESPAÑA / SPAIN  
P.O. Box, 23 - 20.200 - BEASAIN - E-mail: jaso@jaso.com  
Tel. +34 943 - 18 70 00 • Fax. +34 943 - 18 70 20  
[www.jaso.com](http://www.jaso.com)

05/03/2025

FEM 1005 - C25

DELEGACIÓN / DEALER

Reservado el derecho a modificaciones sin previo aviso. Declinamos toda responsabilidad derivada de la información proporcionada / Subject to modification, without prior notice. This information is supplied without liability / L'entreprise se réserve le droit de procéder à des modifications sans préavis. Nous déclinons toute responsabilité quant aux informations fournies / Das Recht auf Änderungen ohne vorherige Ankündigung bleibt vorbehalten. Wir übernehmen keine Gewähr für die gemachten Angaben / Мы оставляем за собой право на внесение изменений без предварительного уведомления. Мы снимаем с себя любую ответственность в отношении предоставленной информации / حقوق التغيير محفوظة دون إشعار مسبق. دون أدنى مسؤولية عن المعلومات المقدمة