



EN 14439
C25

J638PA

GRUA TORRE / TOWER CRANE

GRUE A TOUR / TURMDREHKRAN / БАШЕННЫЙ КРАН / رافعة برجية

FEM 1005 - C25

UNE-EN-ISO 9001

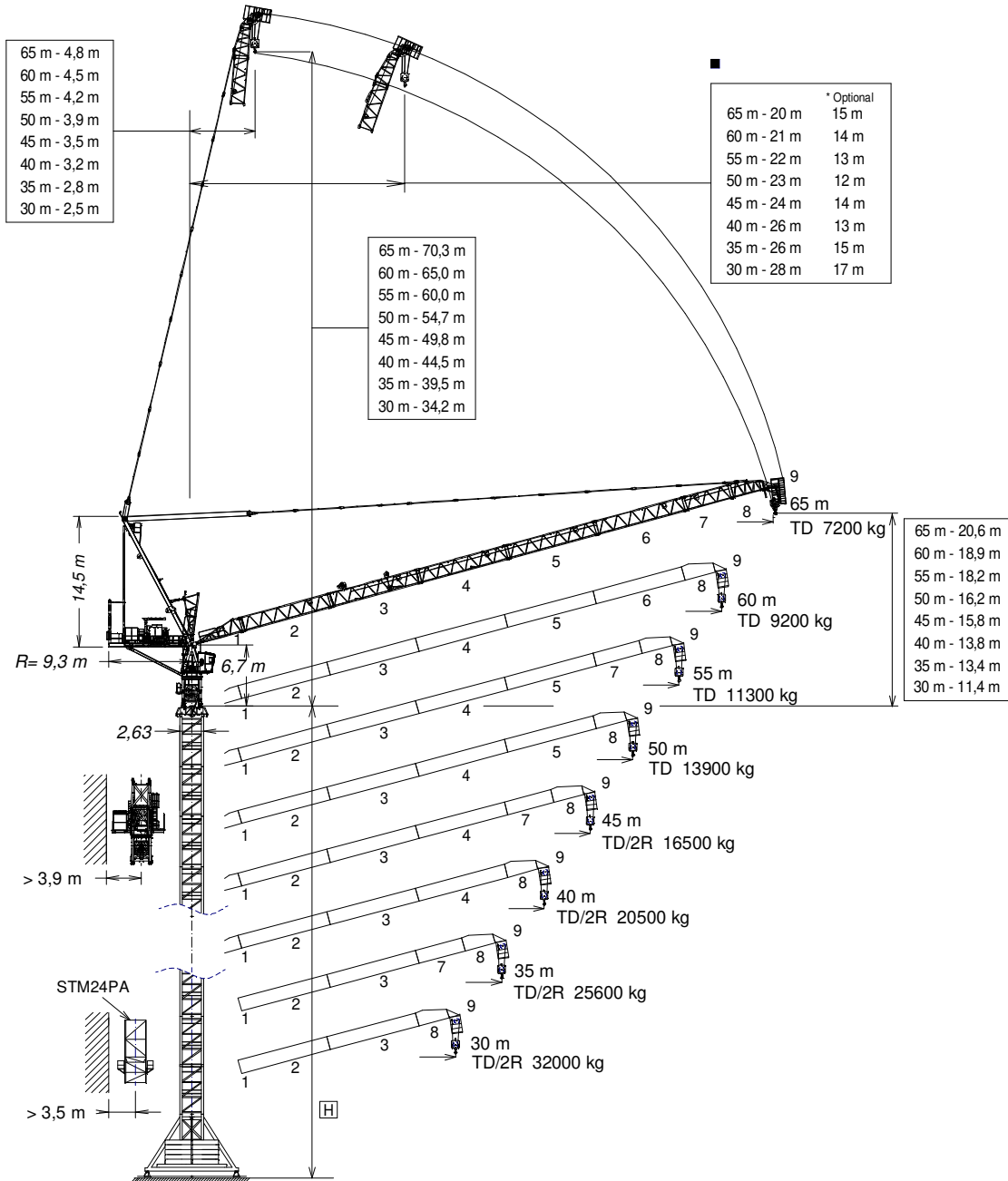

H= Altura máxima bajo gancho sin arriostrar (m). / Maximum height under hook without fastening (m). / Hauteur maximale sous crochet sans ancrage (m).
Max. Hakenhöhe ohne Verstößen (m). / Максимальная высота под крюком без крепления (m). / أقصى ارتفاع تحت الخلف بدون ربط (m).

Tramo pluma 1 / Jib setion 1	216.40.000
Tramo pluma 2 / Jib setion 2	216.41.000
Tramo pluma 3 / Jib setion 3	216.42.000
Tramo pluma 4 / Jib setion 4	216.43.000
Tramo pluma 5 / Jib setion 5	216.44.000

Tramo pluma 6 / Jib setion 6	216.45.000
Tramo pluma 7 / Jib setion 7	216.46.000
Tramo pluma 8 / Jib setion 8	206.47.200
Tramo pluma 9 / Jib setion 9	212.48.000

TR24-5,6	206.32.000
TRD24-5,6	206.32.300
TRID24-5,6	156.30.800
TR24/TSR20	204.36.500

CUSTOMIZE YOUR CRANE

OPTIMUS
line

OPTI Cube	TC Diagnose SYSTEM	CLIMBING Solutions	SAFETY Pack	Personalization	ECO Mode	COMFORT Cabin	HIGH POWER Motors	JL25 Tower Crane Elevator	BE SMART keep control



Reservado el derecho a modificaciones sin previo aviso. Declinamos toda responsabilidad derivada de la información proporcionada / Subject to modification, without prior notice. This information is supplied without liability / L'entreprise se réserve le droit de procéder à des modifications sans préavis. Nous déclinons toute responsabilité quant aux informations fournies / Das Recht auf Änderungen ohne vorherige Ankündigung bleibt vorbehalten. Wir übernehmen keine Gewähr für die gemachten Angaben / Мы оставляем за собой право на внесение изменений без предварительного уведомления. Мы снимаем с себя любую ответственность в отношении предоставленной информации / حقوق التغيير محفوظة دون إشعار مسبق دون أدنى مسؤولية عن المعلومات المقدمة

26/04/2024

(H) ESTACIONARIA / STATIONARY / STATIONAIRE / STATIONÄR / СТАЦИОНАРНОЕ СОСТОЯНИЕ / ثابتة

TD

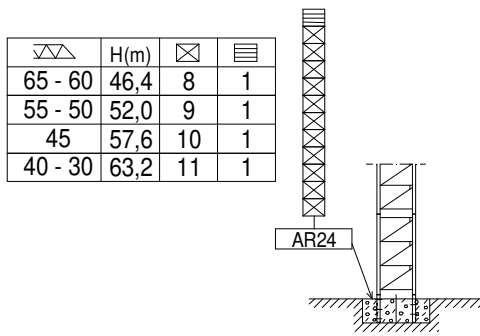

TD / 2R

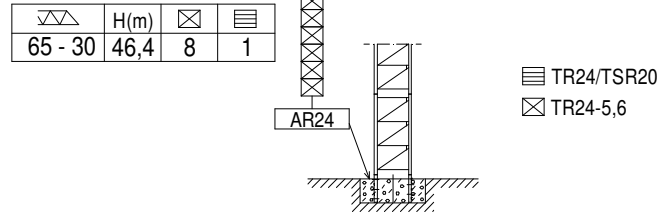

(H) ESTACIONARIA 3 / STATIONARY 3 / STATIONAIRE 3 / STATIONÄR 3 / СТАЦИОНАРНОЕ СОСТОЯНИЕ 3 / ثابتة 3

TD

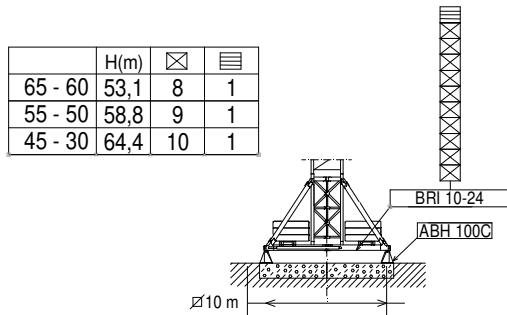

TD / 2R

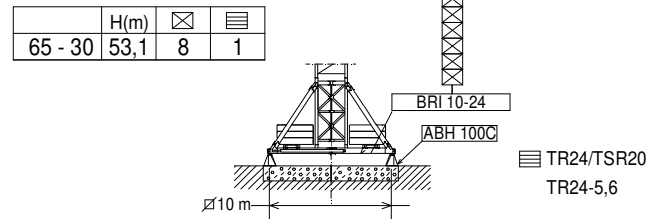

(H) TRASLACION / TRAVELLING / TRASLATION / FORTBEWEGUNG / ПЕРЕМЕЩЕНИЕ / متحركة

TD

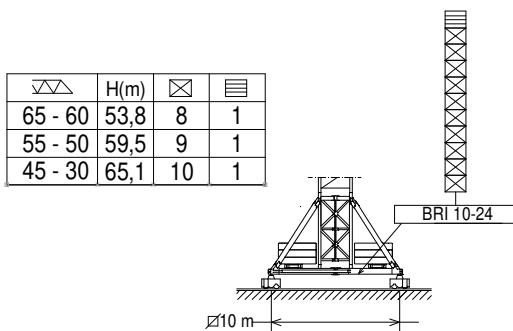

TD / 2R

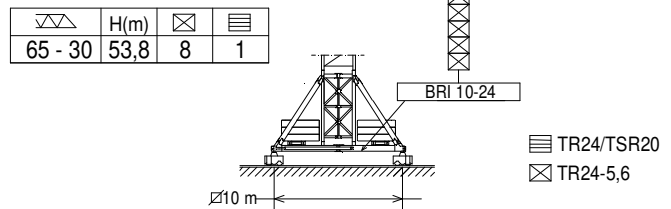



H= Máxima altura de torre sin arriostrar (m). / Maximum tower height without fastening (m). / Hauteur maximale de tour sans ancrage (m). / Maximale Höhe ohne Verstreben (m) / Максимальная высота башни без крепления (м). / أقصى ارتفاع للبرج بدون ربط (م).

ASRD 20/24	156.21.000
AR24	156.21.200
BRI 10-24	156.20.500
ABH 100C	170.23.000

TRD24-5,6	206.32.300
TRID24-5,6	156.30.800
TR24/TSR20	204.36.500

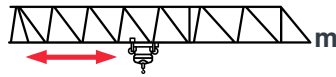
TD (t) – 16 t



	TD 16 t @ ...(m)	25	30	35	40	45	50	55	60	65
65	43,5	16,0	16,0	16,0	16,0	15,1	12,6	10,5	8,7	7,2
60	44,4	16,0	16,0	16,0	16,0	15,6	13,1	11,0	9,2	—
55	45,0	16,0	16,0	16,0	16,0	16,0	13,4	11,3	—	—
50	45,9	16,0	16,0	16,0	16,0	16,0	13,9	—	—	—
45	45,0	16,0	16,0	16,0	16,0	16,0	—	—	—	—
40	40,0	16,0	16,0	16,0	16,0	—	—	—	—	—
35	35,0	16,0	16,0	16,0	—	—	—	—	—	—
30	30,0	16,0	16,0	—	—	—	—	—	—	—

TD / 2R - 16 / 32 (t)

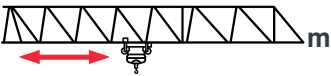
	2R 32 t @ (m)	TD 16 t @ (m)										
			20	25	30	35	40	45	50	55	60	65
65	32 t @ (m)	42,1	16,0	16,0	16,0	16,0	16,0	14,3	11,8	9,7	8,0	6,5
60		43,0	16,0	16,0	16,0	16,0	16,0	14,9	12,4	10,3	8,5	—
55	26,9	43,7	32,0	32,0	27,7	22,4	18,4	15,3	12,7	10,6	—	—
50	27,3	44,6	32,0	32,0	28,3	23,0	18,9	15,8	13,2	—	—	—
45	28,0	45,0	32,0	32,0	29,2	23,8	19,7	16,5	—	—	—	—
40	28,6	40,0	32,0	32,0	30,2	24,7	20,5	—	—	—	—	—
35	29,4	35,0	32,0	32,0	31,2	25,6	—	—	—	—	—	—
30	30,0	30,0	32,0	32,0	32,0	—	—	—	—	—	—	—

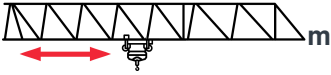
	2R 18 t @ (m)	TD 9 t @ (m)										
			25	30	35	40	45	50	55	60	65	
65	39,1	58,0	18,0	18,0	18,0	17,9	14,3	11,8	9,7	8,0	6,5	

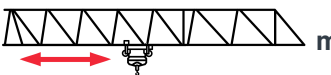
	2R 26 t @ (m)	TD 13 t @ (m)									
			20	25	30	35	40	45	50	55	60
60	31,0	48,6	26,0	26,0	26,0	22,0	18,0	14,9	12,4	10,3	8,5

Datos válidos para / Valid data for / Donnees valables pour / Gultige Daten für / Допустимые данные для / البيانات الصالحة لـ

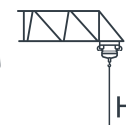

2R H ≤ 110 m
TD H ≤ 220 m

*OPCIONAL / OPTIONAL / EN OPTION / OPTIONAL / ОПЦИОНА / اختياري



EC150152VF
110 kW

*** EC180188VF**
132 kW

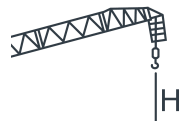
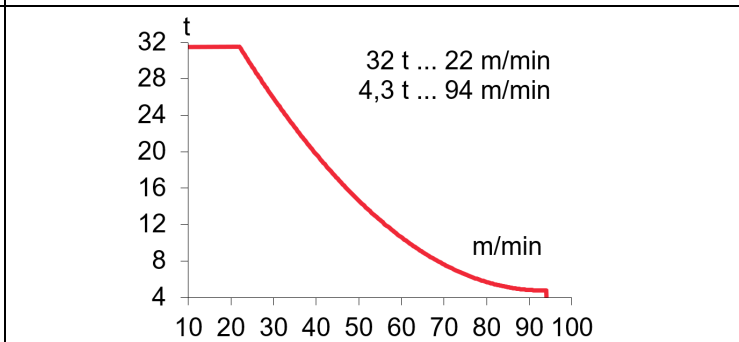
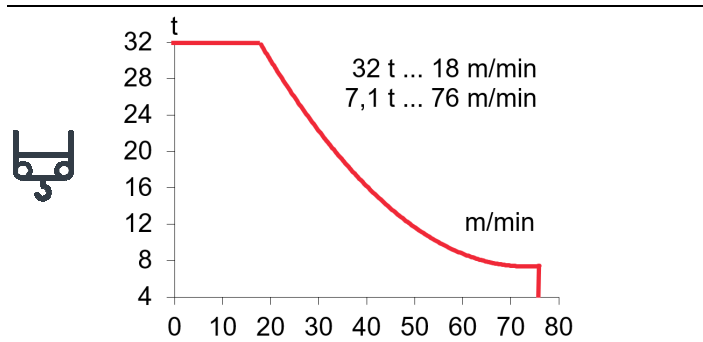
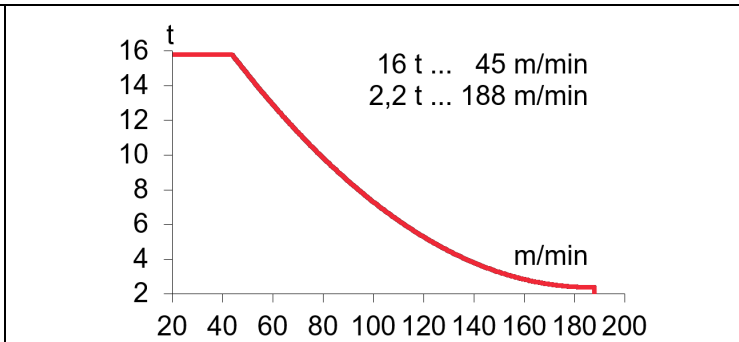
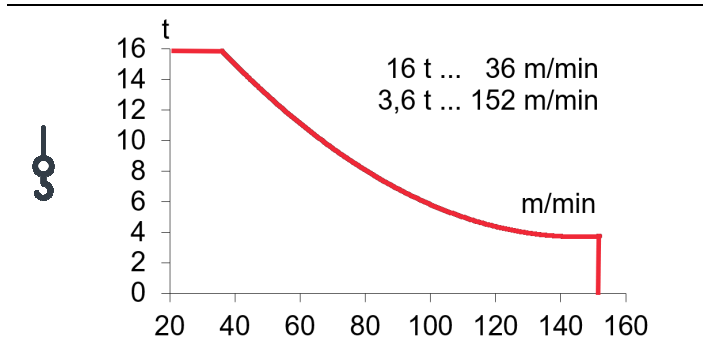

$H \leq \frac{TD}{2R}$ 650 m
325 m

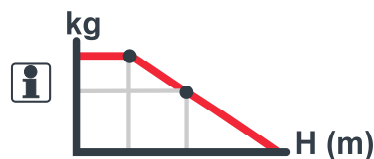

 OG2008VF 2 X 7,3 kW	 EP10015VF 75 kW	 TG4025VF 4 x 7,5 kW	 TH2506 18,4 kW
0...0,8 r/min sl/min	1,5 min	0...25 m/min	0,6 m/min

P_{TOTAL} (EC150152VF + OG2008VF + EP10015VF) = **199,6 kW**
 P_{TOTAL} (*EC180188VF + OG2008VF + EP10015VF) = ***221,6 kW**

400V 50Hz

			L (m)	A (m)	H (m)	P/W(kg)
Torre inferior / Lower tower Tour inférieure / Unterer Turm Нижняя башня / البرج السفلى	TRID24-5,6		5,990	2,142	2,164	8250
Torre desmontada / Dismantled tower Tour démontée / Demontierter Turm Разобранная башня / برج مفكك	TRD24-5,6		5,990	2,530	1,180	4920
Torre / Tower Tour / Turm / Башня / برج	TR24-5,6		5,990	2,720	2,815	4490
Larguero largo, reducción Long crossbar, reduction Traverse longue, réduction Langer Längsträger, Reduzierung Длинная продольная балка عارض طويلة، مُصغر	TR24/TSR20		3,950	0,600	1,814	2267
Larguero corto reducción Short crossbar, reduction Traverse courte, reduction Kurzer Längsträger, Reduzierung Короткая продольная балка, уменьшение / عارضة قصيرة، مُصغر	TR24/TSR20		1,915	0,600	1,814	1058
Torre asiento pista, torre superior y orientación Slewing table, top tower and slewing mechanism Tour pivot + tour supérieure + mécanisme d'orientation Turmsitz + oberer Turm + Ausrichtung Сиденье площадки + верхняя башня + поворотный механизм برج وحدة الدوران + البرج العلوي + آلية الدوران			7,526	2,365	2,544	21100
Punta de torre / Tower head / Porte-flèche Turmspitze / верхняя секция башни / رأس البرج			3,356	2,220	2,077	5800
Torre asiento pista + base punta de torre + orientación Slewing table + tower head base + slewing mechanism Tour pivot + base du porte-flèche + mécanisme d'orientation Turmsitz + Turmspitzenbasis + Ausrichtung Сиденье площадки + основание верхней секции башни + поворотный механизм برج وحدة الدوارن + قاعدة رأس البرج + آلية الدوران			5,225	2,544	2,365	12500
Tramo de pluma Jib section Tronçon de flèche Auslegerabschnitt Секция стрелы أجزاء الذراع	1 2 3 4 5 6 7 8 9		6,186 10,460 10,505 10,550 10,550 10,550 5,615 3,720 2,010	2,160 1,530 1,530 1,530 1,500 1,500 1,500 1,500 1,900	1,760 1,740 1,750 1,750 1,730 1,725 1,725 1,855 2,050	1830 2600 2660 2180 1960 1750 1040 1020 1010
Contrapluma con mecanismos, pasteca y plumin Counterjib with mechanisms, reeving block and auxiliary jib Contre-flèche avec mécanismes et fléchette auxiliaire Gegenausleger + Mechanismus + Unterflasche + Ausleger Противовесная консоль с механизмами и вспомогательной الذراع المعاكس مع آليات وريشة مساعدة			9,105	2,375	2,765	21400

LISTA DE EMBARQUE / PACKING LIST

LISTE DE COLISAGE / KOLLI LISTE / СПИСОК ПОСТАВКИ / قائمة التحميل

J638PA

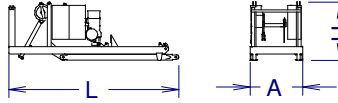
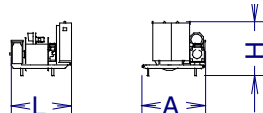
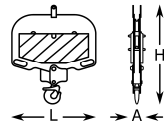
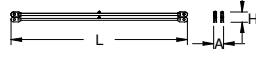
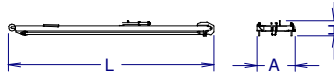
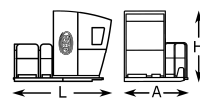
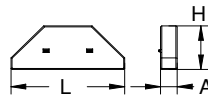
		L (m)	A (m)	H (m)	P/W(kg)
Contrapluma con elevacion pluma, pasteca y plumin Counterjib+ luffing mechanisms+ reeving block+ auxiliary jib Contre-flèche avec mécanisme de relevage de la flèche, moufle et fléchette Gegenausleger + Auslegerhebwerk + Unterflasche + Ausleger Противовесная консоль с механизмом подъема стрелы, блоком и дополнительной стрелой الذراع المعاكس مع رافع الذراع والبكرة والريشة الاضافية		9,105	2,200	2,555	14300
Mecanismo elevacion carga / Hoisting mechanism Mécanisme de levage de charge Lasthubmechanismus Подъем груза / رافع الحمولة		2,650	2,470	2,170	8690
Polipasto / Hook assembly Palan / Flaschenzug Полиспаст / بكرة	TD/2R TD 	1,010 0,180	0,414 0,3458	1,985 2,090	785 380
Tirante sostén pluma / Jib support tie Tirant de fleche Haltestange Ausleger Растяжка поддержки / مشد دعامة الذراع		5,410	0,430	0,615	2100
Parte superior / Top part Partie supérieure / Oberteil		12,469	2,310	2,261	12300
Plataforma y cabina / Platform and cabin Plateforme et cabine / Plattform + Führerstand Платформа и кабина / منصة وكابينة		3,670	1,925	2,480	1130
Contrapeso / Counterweight Contrepoids / Gegengewicht Противовес / اوزان معاكسة	Lastre / Ballast / Lest Ballast / Балласт / ثقيل نقل 	3,800	0,580	1,500	6000

TRANSPORTE / TRANSPORT / TRANSPORT / TRANSPORT / ТРАНСПОРТИРОВКА / نقل

J638PA



H = 8 x TR24-5,6 + TR24/TSR20 + ASRD 20/24 + 

10 x



10 x



 **Viento fuera de servicio / Out of service wind / Vitesse du vent hors service / Wind außer betrieb / Ветровая нагрузка в покое / الريح خارج الخدمة**

 **Consultar / Consult / Nous consulter / Anfragen / Консультируйтесь / الرجوع إلى**

 **En servicio / In service / En service / In betrieb / В работе / في الخدمة**

 **Fuera de servicio / Out of service / Hors service / Außer betrieb / В покое / خارج الخدمة**



Ctra./ Rd. Madrid – Irún - Km. 415 - 20213 IDIAZABAL (Gipuzkoa) - ESPAÑA / SPAIN

P.O. Box, 23 - 20.200 - BEASAIN - E-mail: jaso@jaso.com

Tel. +34 943 - 18 70 00 • Fax. +34 943 - 18 70 20

www.jaso.com

26/04/2024



FEM 1005 – C25

DELEGACIÓN / DEALER

Reservado el derecho a modificaciones sin previo aviso. Declinamos toda responsabilidad derivada de la información proporcionada / Subject to modification, without prior notice. This information is supplied without liability / L'entreprise se réserve le droit de procéder à des modifications sans préavis. Nous déclinons toute responsabilité quant aux informations fournies / Das Recht auf Änderungen ohne vorherige Ankündigung bleibt vorbehalten. Wir übernehmen keine Gewähr für die gemachten Angaben / Мы оставляем за собой право на внесение изменений без предварительного уведомления. Мы снимаем с себя любую ответственность в отношении предоставленной информации / حقوق التغيير محفوظة دون إشعار مسبق. دون أدنى مسؤولية عن المعلومات المقدمة