

H_{SR} = Altura máxima bajo gancho sin arristrar (ft).
Maximum height under hook without fastening (ft).

(H) TRASLACIÓN / TRAVELLING /

(H) ESTACIONARIA / STATIONARY

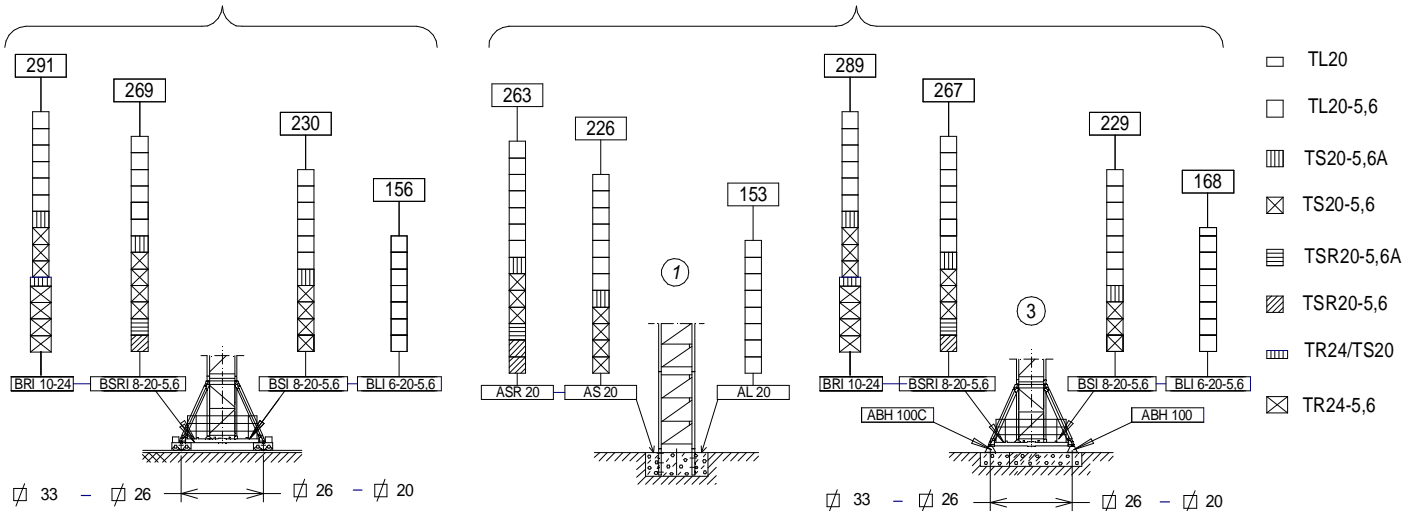













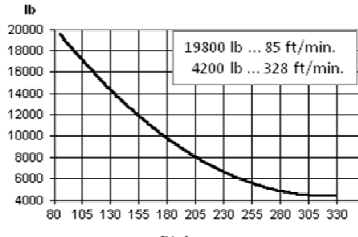
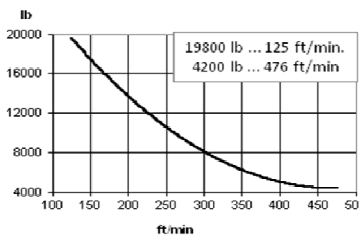

CARGAS / LOADS

J360

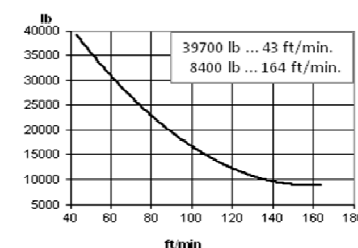
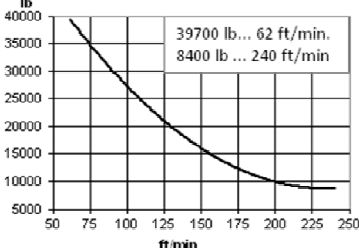
SR/DR (lb)		Cargas máximas / Maximum loads SR / DR – 19800/39700 (lb)									
[ft]	19800/39700 lb @ ... (ft)	Alcance del gancho [ft] / Hook reach [ft]									
		49	66	82	98	115	131	148	164	180	197
197	102/55	19800/39700	19800/32500	19800/25400	19800/20700	17300	14700	12800	11200	9900	8800
180	111/59	19800/39700	19800/35600	19800/27900	19800/22800	19100	16300	14200	12400	11000	—
164	125/67	19800/39700	19800/39700	19800/31700	19800/25900	19800/21800	18700	16300	14300	—	—
148	140/75	19800/39700	19800/39700	19800/36200	19800/29600	19800/25000	19800/21500	18700	—	—	—
131	131/77	19800/39700	19800/39700	19800/37100	19800/30400	19800/25600	19800/22000	—	—	—	—
115	115/79	19800/39700	19800/39700	19800/38300	19800/31400	19800/26500	—	—	—	—	—
98	98/81	19800/39700	19800/39700	19800/39000	19800/32000	—	—	—	—	—	—

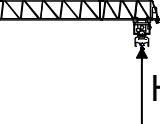
CARACTERÍSTICAS DE MECANISMOS / MECHANISMS

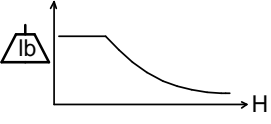
J360

*opcional *optional						
	*EC60100VF 45 kW	EC88145VF 65 kW	TC760VF 5,5 kW	OG2208VF 3x5,5 kW	TG4025VF 4x7,5 kW	TH2006 15 kW
	 <p>19800 lb ... 85 ft/min. 4200 lb ... 328 ft/min.</p>	 <p>19800 lb ... 125 ft/min. 4200 lb ... 476 ft/min.</p>	<p>19800 lb 0...197 ft/min</p> <p>39700 lb 0...98 ft/min</p>	<p>0...0,8 r/min sl/min</p>	<p>0...82 ft/min</p>	<p>2 ft/min</p>
	 <p>39700 lb ... 43 ft/min. 8400 lb ... 164 ft/min.</p>	 <p>39700 lb ... 62 ft/min. 8400 lb ... 240 ft/min.</p>	<p> 480V 60Hz</p> <p>EC60100VF: AMPERAGE = 117 A EC88145VF: AMPERAGE = 155 A</p>			
	$H \leq \begin{matrix} SR \\ DR \end{matrix}$ <p>1076 ft 538 ft</p>	<p> </p>				
	2831 ft	<p> ecoMode</p>				

LASTRES INFERIORES / LOWER BALLASTS

J360

BRI 10-24	H (ft)	255	273	291
	P (lb)	105800	158700	211600
BSRI 8-20-5,6	H (ft)	232	251	269
	P (lb)	158700	211600	264600
BSI 8-20-5,6	H (ft)	175	212	230
	P (lb)	105800	132300	158700
BLI 6-20-5,6	H (ft)	83	120	168
	P (lb)	158700	185200	238100

H: Altura bajo gancho / Height under hook





Para alturas intermedias tomar el lastre correspondiente a la altura superior / For intermediate heights take the ballast corresponding to the higher height

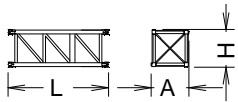
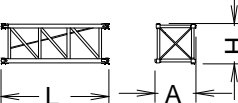
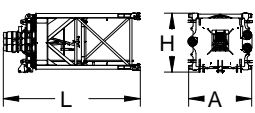
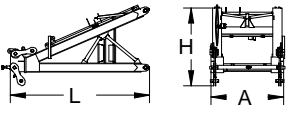
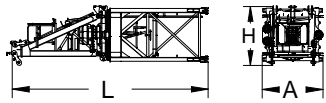

Fecha / Date: 25/11/2022

 **FEM 1001**

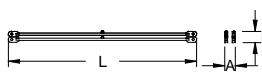
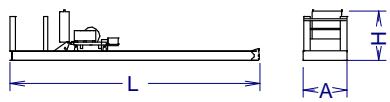
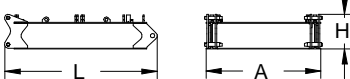
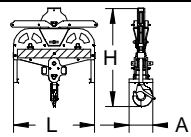
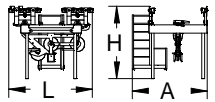
Reservado el derecho a modificaciones sin previo aviso. Declinamos toda responsabilidad derivada de la información proporcionada / Subject to modification, without prior notice. This information is supplied without liability /

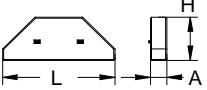
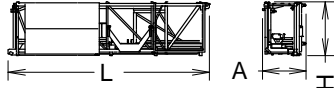
DENOMINACIÓN / DENOMINATION		L [ft]	A [ft]	H [ft]	P / W [lb]	
Torre inferior <i>Lower tower</i>	TLI20-5,6		19.3	7.6	7.7	9340
	TSI20-5,6		19.6	7.6	7.8	11880
	TSRI20-5,6		19.7	7.4	7.4	14470
	TRID24-5,6		19.7	10.5	10.5	18520
Torre <i>Tower</i>	TL20		13.7	7.2	7.5	4620
	TL20-5,6		19.3	7.6	7.7	6415
	TS20-5,6		19.6	7.8	7.6	7780
	TSR20-5,6		19.6	7.6	7.8	7830
	TSR20-5,6A		19.4	7.8	7.6	9195
	TS20-5,6A		19.7	7.8	7.4	9280
	TR24-5,6		19.7	9.1	9.3	10500
	TRD24-5,6		19.6	9.0	7.5	11640
Torre asiento pista + base punta de torre + orientación <i>Slewing table + tower head base + slewing mechanism</i>			17.5	8.2	8.3	17750
Punta de torre <i>Tower head</i>			12.0	6.5	6.5	5730
Torre asiento pista + base punta de torre + orientación <i>Slewing table + tower head base + slewing mechanism</i>			26.6	8.2	8.3	23480
Tramo de pluma <i>Jib section</i>	PT19-11		33.4	5.7	7.2	5830
	PT19-12+Tr		33.5	5.2	7.3	6650
	PT19-13		17.3	5.2	7.2	3030
	PT19-14		33.5	5.2	6.6	5275
	PT19-15		33.5	5.2	6.6	3560
	PT19-16		33.4	5.2	6.6	2955
	PT19-17		16.9	5.2	6.6	1275
	PP19-18		2.2	5.7	2.2	390
Tirante sostén pluma <i>Jib support tie</i>			21.5	5.9	1.1	5005
Contrapluma 2 con mecanismos (sin cable) y plumín auxiliar <i>Counterjib 2 with mechanism (without rope), and auxiliary jib</i>			39.4	6.9	7.7	16615
Contrapluma I <i>Counterjib I</i>			8.3	6.3	1.9	2105
Polipasto <i>Hook assembly</i>		SR/DR 	4.5	1.3	5.4	1125
Carro <i>Trolley</i>		SR/DR 	7.2	7.8	6.0	1970
Plataforma y cabina (2 x 1,5) <i>Platform and cabin</i>			11.5	6.8	7.9	2390
Contrapeso <i>Counterweight</i>	Lastre <i>Ballast</i>		12.5	1.9	4.9	13230
			12.5	0.9	4.9	6615
			12.5	0.6	4.9	4410
Transporte torre de montaje <i>Jacking cage transport</i>		TM20L-5,6 	31.3	6.8	8.3	12550

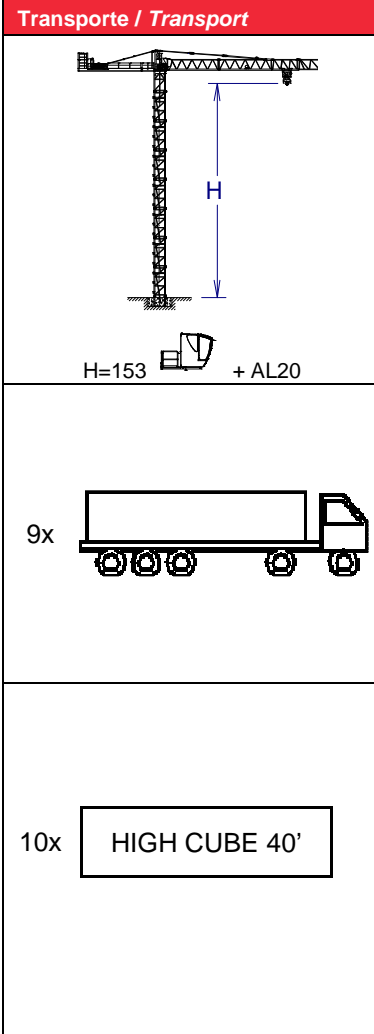
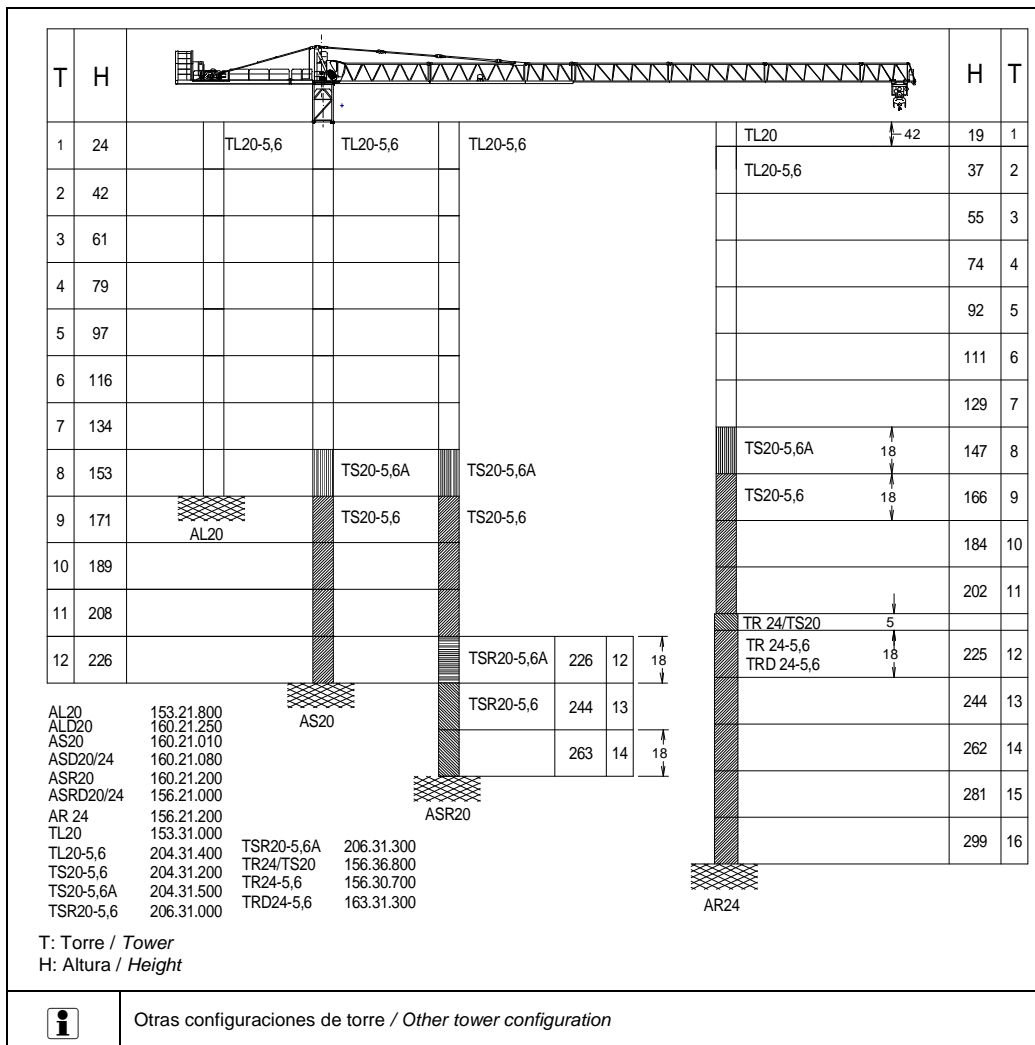

TREPADO / CLIMBING J360

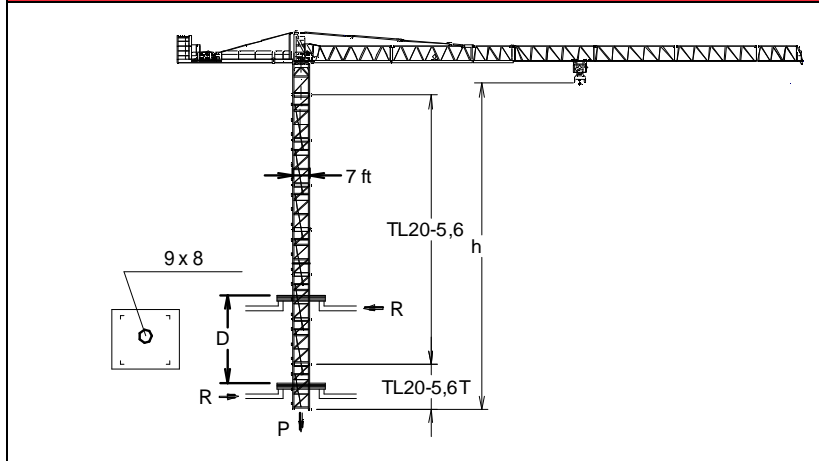

$h_{max} = TL20-5,6T + 6 \times TL20-5,6$

h (ft)	134
D (ft)	39 - 62
P (lbf)	265300 224800
Rmax (lbf)	64100 86600

TL20-5,6T: 136.32.700

Trepado interno / Internal climbing.

- Viento fuera de servicio / Out of service wind
- Consultar / Consult
- En servicio / In service
- Fuera de servicio / Out of service



Ctra./Rd. Madrid - Irún Km. 415 - 20.213 IDIAZABAL [Gipuzkoa] ESPAÑA / SPAIN
 P.O. Box, 23 - 20.200 BEASAIN - E-mail: jaso@jaso.com
 Tel. +34 943 - 18 70 00 • Fax. +34 943 - 18 70 20
www.jaso.com

Fecha / Date: 25/11/2022

FEM 1001

DELEGACION / DEALER

Reservado el derecho a modificaciones sin previo aviso. Declinamos toda responsabilidad derivada de la información proporcionada
 Subject to modification, without prior notice. This information is supplied without liability