

H= Altura máxima bajo gancho sin arriostrar (m) / Maximum height under hook without fastening (m).

PC22-21R	156.40.700	PT22-5R	156.44.200	TSR20	206.31.200	TR24-5,6	206.32.000
PC22-22R	156.41.400	PT22-6	156.45.000	TSR20-5,6	206.31.000	TRD24-5,6	206.32.300
PC22-3R	156.42.200	PT22-27R	156.46.400	TR24/TSR20	204.36.500		
PC22-4R	156.43.500	PT22-8	156.47.000				

CUSTOMIZE YOUR CRANE

OPTIMUS
line JASD



OPTI Cubo



TC Diagnosis SYSTEM



CLIMBING Solution



SAFETY Pack



Customization



ECO Mode



COMFORT Cabin



HIGH POWER Motors



JL25 Tower Crane Elevator



BE SMART keep control

(H) ESTACIONARIA 1 / STATIONARY 1

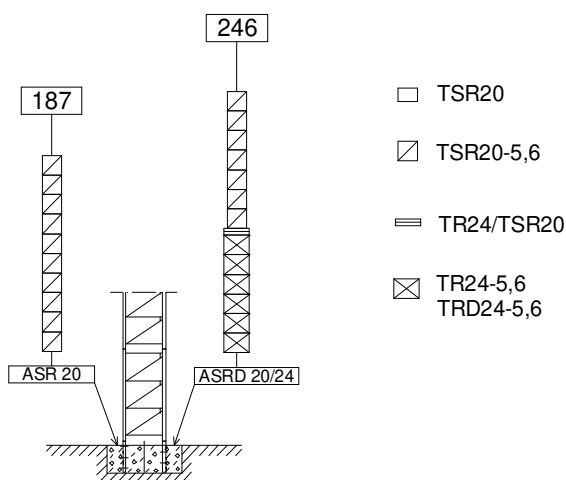

(H) ESTACIONARIA 3 / STATIONARY 3

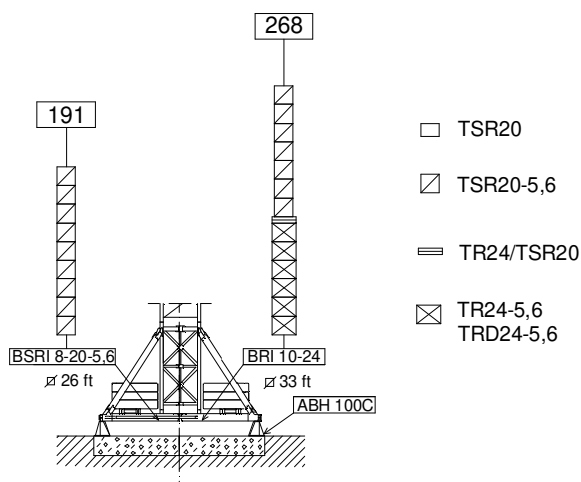

(H) TRASLACION / TRAVELLING

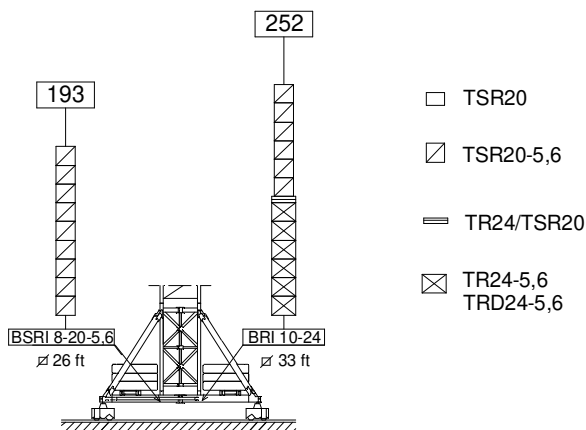

ASR20 160.21.200
ASRD 20/24 156.21.000

BSRI 8-20-5,6 204.20.000
BRI 10-24 156.20.500

ABH 100C 170.23.000

CARGAS / LOADS

J700



ST-SR
26500 lb

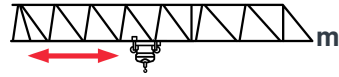

	26500 lb @ ...(m)	82	98	113	131	151	169	187	207	225	244	262
262	142	26500	26500	26500	26500	24700	21500	19000	16700	15000	13400	12100
244	148	26500	26500	26500	26500	25900	22600	19900	17600	15800	14100	—
225	169	26500	26500	26500	26500	26500	26500	23500	20800	18700	—	—
207	180	26500	26500	26500	26500	26500	26500	25400	22500	—	—	—
187	183	26500	26500	26500	26500	26500	26500	25800	—	—	—	—
169	169	26500	26500	26500	26500	26500	26500	—	—	—	—	—
151	151	26500	26500	26500	26500	26500	—	—	—	—	—	—
131	131	26500	26500	26500	26500	—	—	—	—	—	—	—
113	113	26500	26500	26500	—	—	—	—	—	—	—	—

CARGAS / LOADS

J700



ST-DR
52900 lb

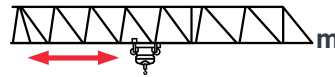

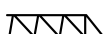
	52900 lb @ ...(m)	82	98	113	131	151	169	187	207	225	244	262
262	75	48100	39000	33100	27600	23200	20000	17500	15200	13400	11800	10600
244	78	50300	40800	34600	29000	24400	21100	18400	16000	14200	12600	—
225	90	52900	47600	40500	34100	28800	25000	22000	19300	17200	—	—
207	95	52900	51100	43600	36700	31100	27100	23800	20900	—	—	—
187	97	52900	51900	44300	37300	31600	27500	24300	—	—	—	—
169	100	52900	52900	46000	38800	32800	28700	—	—	—	—	—
151	103	52900	52900	47700	40300	34200	—	—	—	—	—	—
131	104	52900	52900	48300	40800	—	—	—	—	—	—	—
113	105	52900	52900	48500	—	—	—	—	—	—	—	—

Datos válidos para / Valid data for

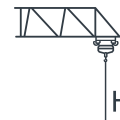

H ≤ 230 ft

 **FEM 1001**



Reservado el derecho a modificaciones sin previo aviso. Declinamos toda responsabilidad derivada de la información proporcionada / Subject to modification, without prior notice. This information is supplied without liability



EC88115VF
65 kW

*** EC150185VF**
110 kW

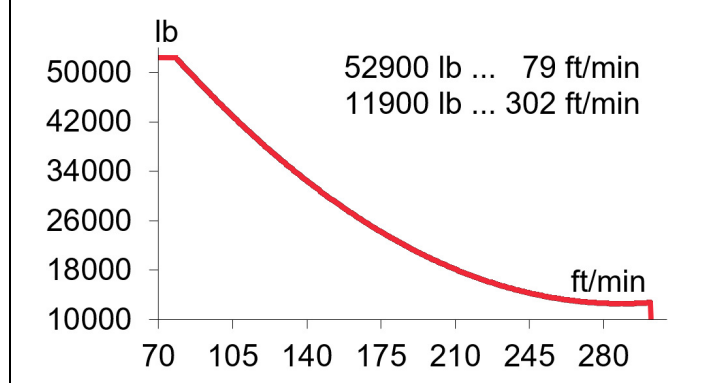
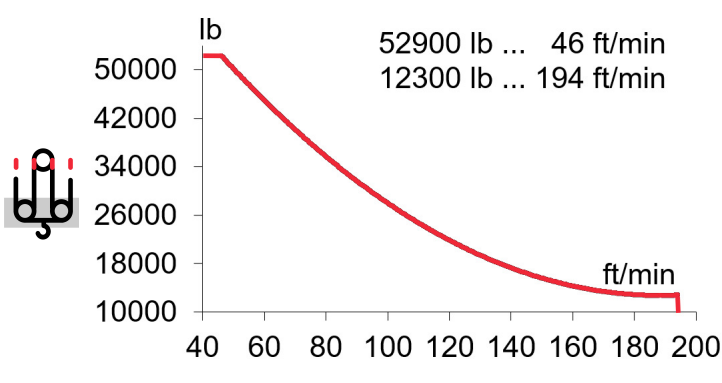
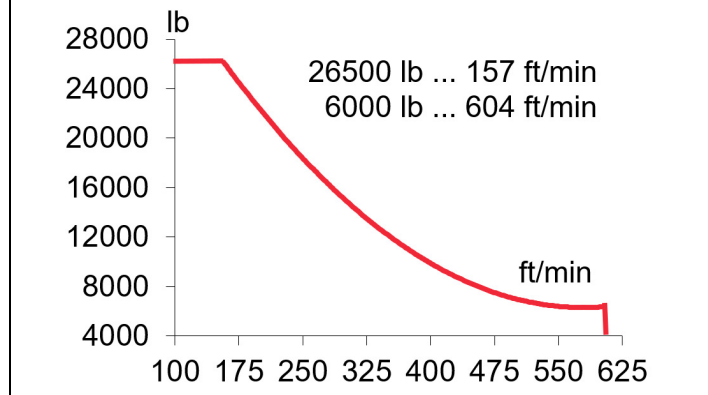
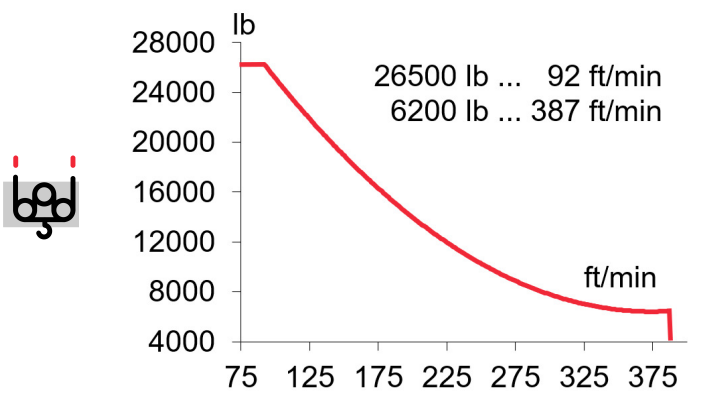

H ≤ SR 1200 ft
DR 600 ft



H ≤ SR 1430 ft
DR 715 ft

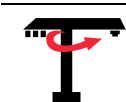
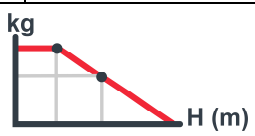

OG4006VF
4 x 7,5 kW



TC15105VF
11 kW



TG4025VF
4 x 7,5 kW

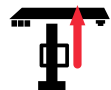

TH4010
29,4 kW

0...0,8
r/min
sl/min

26500 lb
0...344 ft/min
52900 lb
0...171 ft/min



0...82
ft/min

2 ft/min

⚡ 3~ 400V 50Hz
480V 60Hz

KVA			
EC88115VF	78	94	109
EC150185VF	100	126	153

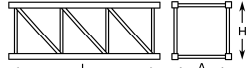
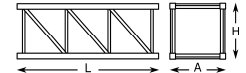
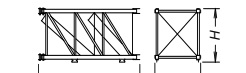
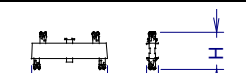
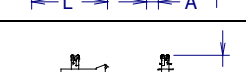
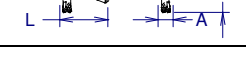
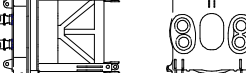
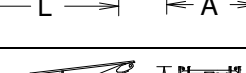
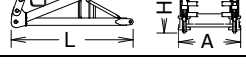
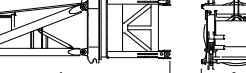
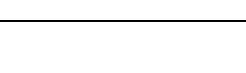
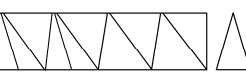

		L (m)	A (m)	H (m)	P/W (kg)	
Torre inferior / Lower tower	TSRI-20-5,6		19.7	7.4	7.4	15125
Torre / Tower	TSR20		14.0	7.4	7.4	6860
	TSR20-5,6		19.7	7.4	7.4	9280
	TR24-5,6		19.7	9.1	9.3	10500
Torre desmontada / Dismantled tower	TRD24-5,6		19.7	3.8	8.3	11640
Larguero largo, reducción / Long rossbar, reduction	TR24/TSR20		15.9	2.1	5.5	6280
Larguero corto reducción / Short crossbar, reduction	TR24/TSR20		7.8	1.9	5.5	3190
Torre asiento pista + base punta de torre + orientación Slewing table + tower head base + slewing mechanism			15.4	8.1	8.4	27160
Punta de torre / Tower head			14.3	7.3	6.6	9490
Conjunto asiento pista, punta de torre y orientación Slewing table assembly, tower head and slewing mechanism			26.7	8.2	8.4	36650
Tramo de pluma Jib section	PC22-21R (1)		38.2	7.3	8.2	11685
	PC22-22R (2)		38.5	7.1	8.1	13000
	PC22-3R (3)		38.5	6.8	8.1	13525
	PC22-4R (4) + Tr		38.5	6.8	8.1	12800
	PT22-5R (5)		38.5	6.8	8.1	6715
	PT22-6 (6)		38.5	6.8	8.1	4710
	PT22-27R (7)		19.4	6.8	8.0	2615
	PT22-8 (8)		19.2	6.8	7.9	2000
Polipasto / Hook assembly	ST/DR		6.8	2.3	4.5	2500
Carro / Trolley	ST/DR		10.7	7.6	7.2	3010
Plataforma y cabina / Platform and cabin			12.7	7.3	8.2	2760
Contrapluma con plataformas / Counterjib with platforms			37.8	11.2	7.6	21100
Transporte torre de montaje / Jacking cage transport	TM20PASR-5,6		35.5	7.5	7.9	26765

LISTA DE EMBARQUE / PACKING LIST

J700

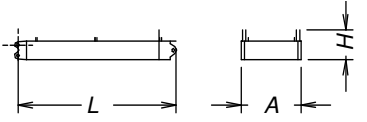
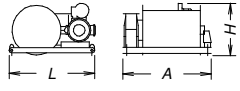
		L (m)	A (m)	H (m)	P/W(kg)
Prolongación contrapluma con plataforma / Counterjib extension with platform		18.0	6.6	3.1	5645
Soporte y elevación (sin cable) / Support and hoisting (without rope)		8.2	6.9	4.1	7830

LASTRES INFERIORES / LOWER BALLASTS

J700

BRI 10-24	H (m)	197	268
	P (t)	105800	185200
BSRI 8-20-5,6	H (m)	119	193
	P (t)	158700	264600



H: Altura bajo gancho / Height under hook

Para alturas intermedias tomar el lastre correspondiente a la altura superior / For intermediate heights take the ballast corresponding to the higher height

TREPADO / CLIMBING

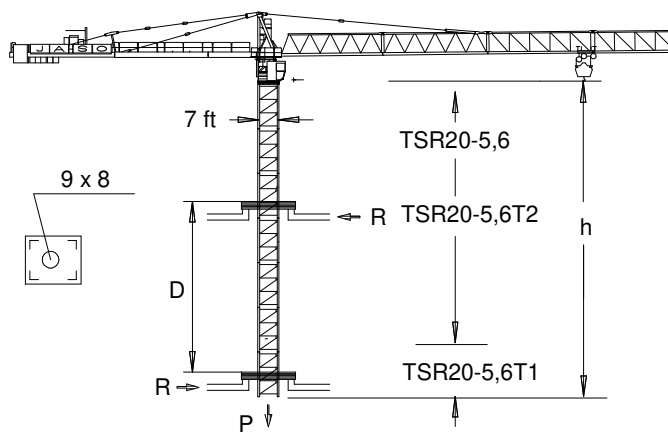
J700



h _{max} :		
TSR20-5,6T1 + 5 x TSR20-5,6 + TSR20-5,6T2		
		
h (ft)	132	
D (ft)	47 - 59	
P (lbf)	373860	319900
R _{max} (lbf)	100040	130840
	TSR20-5,6T1: 206.31.400	
	TSR20-5,6T2: 206.31.500	

 Trepado interno / Internal climbing

 Viento fuera de servicio / Out of service wind

 Consultar / Consult

 En servicio / In service

 Fuera de servicio / Out of service

 Opcional / Optiona



Ctra./ Rd. Madrid - Irún - Km. 415 - 20213 IDIAZABAL (Gipuzkoa) - ESPAÑA / SPAIN
 P.O. Box, 23 - 20.200 - BEASAIN - E-mail: jaso@jaso.com
 Tel. +34 943 - 18 70 00 • Fax. +34 943 - 18 70 20
www.jaso.com

31/03/2025



FEM 1001

DELEGACIÓN / DEALER