

*OPTIONAL EXTRA LIFT

H= Altura máxima bajo gancho sin arriostrar (m). / Maximum height under hook without fastening (m).

CUSTOMIZE YOUR CRANE

OPTIMUS
line JASD

EXTRA Lift	OPTI Cube	TC Diagnose SYSTEM	CLIMBING Solutions	SAFETY Pack	Personalization	ECO Mode	COMFORT Cabin	HIGH POWER Motors	JL25 Tower Crane Elevator	BE SMART keep control

(H) ESTACIONARIA 1 / STATIONARY 1

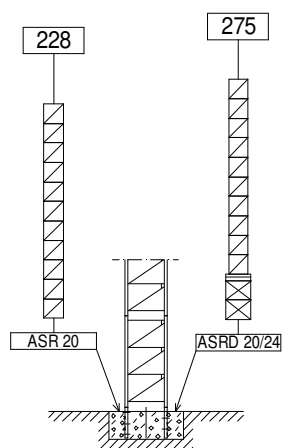

- ▣ TSR20
- ▢ TSR20-5,6
- ≡ TR24/TSR20
- ⊠ TR24-5,6
TRD24-5,6

(H) ESTACIONARIA 3 / STATIONARY 3

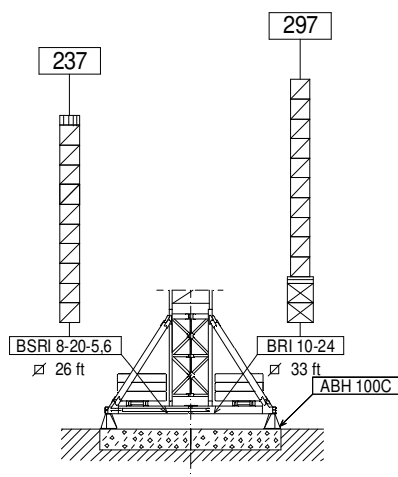

- ▣ TSR20
- ▢ TSR20-5,6
- ≡ TR24/TSR20
- ⊠ TR24-5,6
TRD24-5,6

(H) TRASLACIÓN / TRAVELLING

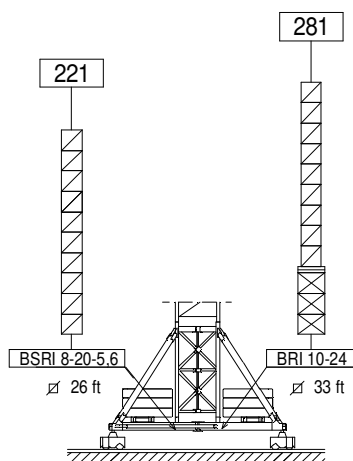

- ▣ TSR20
- ▢ TSR20-5,6
- ≡ TR24/TSR20
- ⊠ TR24-5,6
TRD24-5,6

ST-SR - 26500 lb

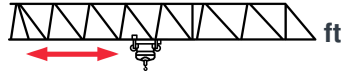

	26500 lb @ ... (ft)	82	98	115	131	148	164	180	197	213	230	246	262	279	
279	91	26500	24000	19900	16800	14500	12600	11000	9700	8600	7700	6900	6100	5500	
	97	26500	25900	21500	18200	15700	13600	12000	10600	9400	8400	7500	6700	6100	+
262	104	26500	26500	23500	20000	17300	15100	13300	11800	10500	9500	8500	7700	—	+
	111	26500	26500	25400	21600	18700	16300	14400	12800	11500	10300	9300	8400		+
246	115	26500	26500	26500	22600	19600	17200	15200	13500	12100	11000	9900	—	—	+
	123	26500	26500	26500	24400	21200	18600	16400	14700	13200	11900	10800			+
230	124	26500	26500	26500	24600	21400	18800	16700	14900	13400	12100	—	—	—	+
	132	26500	26500	26500	26500	23100	20300	18100	16200	14600	13200				+
213	145	26500	26500	26500	26500	25900	22900	20400	18300	16500	—	—	—	—	+
	155	26500	26500	26500	26500	26500	24700	22000	19800	17900					+
197	148	26500	26500	26500	26500	26500	23400	20900	18700	—	—	—	—	—	+
	158	26500	26500	26500	26500	26500	25300	22600	20300						+
180	161	26500	26500	26500	26500	26500	25900	23100	—	—	—	—	—	—	+
	172	26500	26500	26500	26500	26500	26500	24900							+
164	164	26500	26500	26500	26500	26500	26500	—	—	—	—	—	—	—	+
	164	26500	26500	26500	26500	26500	26500								+
148	148	26500	26500	26500	26500	26500	—	—	—	—	—	—	—	—	+
	148	26500	26500	26500	26500	26500									+
131	131	26500	26500	26500	26500	—	—	—	—	—	—	—	—	—	+
	131	26500	26500	26500	26500										+
115	115	26500	26500	26500	—	—	—	—	—	—	—	—	—	—	+
	115	26500	26500	26500											+
98	98	26500	26500	—	—	—	—	—	—	—	—	—	—	—	+
	98	26500	26500												+

ST - DR - 52900 lb

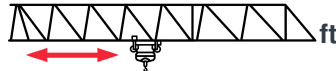

	52900 lb @ ... (ft)	66	82	98	115	131	148	164	180	197	213	230	246	262	279	
279	49	37500	28900	23100	19000	15900	13500	11600	10000	8700	7500	6600	5800	5000	4400	
	50	39000	30100	24200	19900	16700	14200	12300	10600	9300	8100	7200	6300	5600	4900	+
262	55	43800	33900	27300	22600	19000	16200	14000	12300	10700	9500	8400	7400	6600	—	+
	57	45500	35300	28500	23700	20000	17200	14900	13100	11500	10200	9100	8100	7300		+
246	61	49000	38000	30700	25500	21600	18600	16100	14100	12500	11100	9900	8800	—	—	+
	63	50800	39600	32100	26700	22700	19600	17100	15100	13400	11900	10700	9600			+
230	66	52900	41300	33400	27800	23600	20300	17700	15600	13800	12300	11000	—	—	—	+
	68	52900	43000	34900	29200	24900	21500	18850	16700	14800	13300	12000				+
213	77	52900	49400	40200	33600	28700	24900	21800	19300	17200	15400	—	—	—	—	+
	80	52900	51300	41900	35200	30200	26300	23100	20600	18500	16700					+
197	78	52900	50400	41000	34400	29300	25400	22300	19800	17600	—	—	—	—	—	+
	81	52900	52300	42800	36000	30900	27000	23800	21200	19000						+
180	86	52900	52900	45200	37900	32500	28200	24800	22000	—	—	—	—	—	—	+
	89	52900	52900	47100	39800	34300	30000	26500	23700							+
164	87	52900	52900	46100	38700	33100	28800	25400	—	—	—	—	—	—	—	+
	90	52900	52900	48000	40600	35100	30700	27300								+
148	88	52900	52900	46500	39100	33500	29100	—	—	—	—	—	—	—	—	+
	91	52900	52900	48500	41000	35450	31100									+
131	89	52900	52900	47500	39900	34200	—	—	—	—	—	—	—	—	—	+
	93	52900	52900	49400	41700	36000										+
115	89	52900	52900	47500	39900	—	—	—	—	—	—	—	—	—	—	+
	93	52900	52900	49400	41500											+
98	90	52900	52900	47600	—	—	—	—	—	—	—	—	—	—	—	+
	93	52900	52900	49300												+

Datos válidos para / Valid data for



H ≤ 213 ft



*OPCIONAL / OPTIONAL



EC88115VF
65 kW

***EC150205VF**
110 kW

***EC180262VF**
132 kW

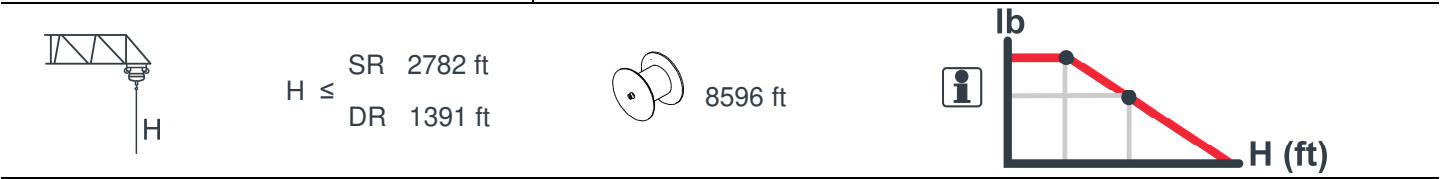
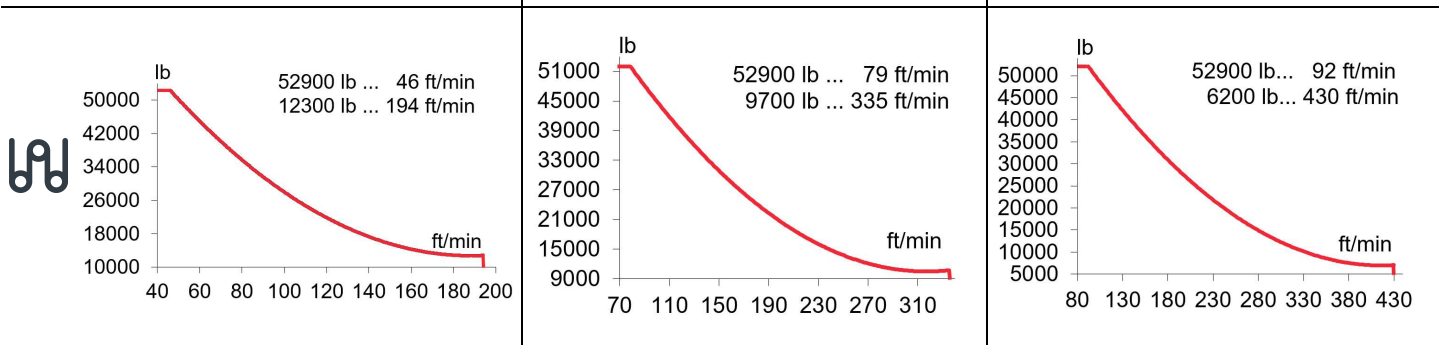
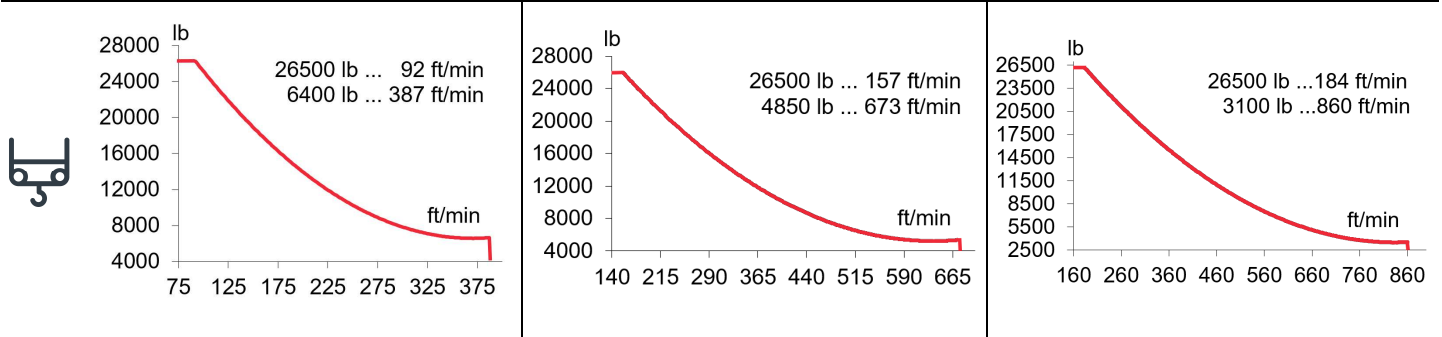

Model	Power (kW)	Max Load (lb)	Max Height (ft/min)
OG4006VF	4 x 7,5	26500	344
TC15105VF	11	52900	171
TG4025VF	4 x 7,5	0...82	ft/min
TH4010	29,4	2	ft/min

EC88115VF: AMPERAGE = 182 A
 EC150205VF: AMPERAGE = 241 A
 EC180262VF: AMPERAGE = 279 A

480V 60Hz

LISTA DE EMBARQUE / PACKING LIST
J560

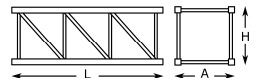
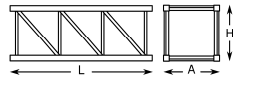
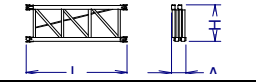
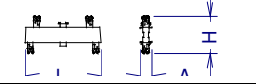
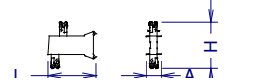
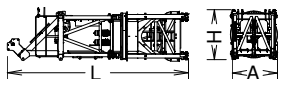
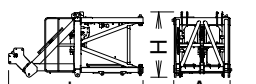
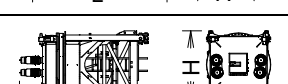
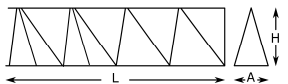
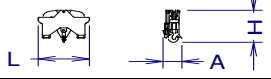
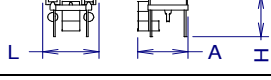
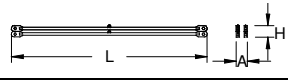
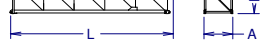
			L [ft]	A [ft]	H [ft]	P / W [lb]
Torre inferior Lower tower	TSRI-20-5,6 TRID24-5,6		19.7	7.4	7.4	15120
			19.7	10.5	10.5	18520
Torre Tower	TSR20 TSR20-5,6 TR24-5,6,6		14.0	7.4	7.4	6860
			19.7	7.4	7.4	9280
			19.7	9.1	9.3	10500
Torre desmontada Dismantled tower	TRD24-5,6		19.7	3.8	8.3	11640
Larguero largo, reducción Long crossbar, reduction	TR24/TSR20		13.0	2.0	6.0	5000
Larguero corto reducción Short crossbar, reduction	TR24/TSR20		6.3	2.0	6.0	2330
Torre asiento pista, torre superior y orientación Slewing table, top tower and slewing mechanism			29.2	7.6	8.1	37260
Punta de torre Tower head			16.8	8.0	7.0	10915
Torre asiento pista + base punta de torre + orientación Slewing table + tower head base + slewing mechanism			15.3	7.6	8.1	26345
Tramo de pluma Jib section	PC19-1		33.7	6.1	7.3	9300
	PC19-2+tr		33.7	5.2	7.9	11870
	PC19-33		33.7	5.2	7.1	10870
	PC19-34		33.7	5.2	7.2	9100
	PT19-35		33.8	5.2	7.2	6050
	PT19-36		33.8	5.2	7.2	4600
	PT19-37		33.7	5.2	7.1	3770
	PT19-8		33.7	5.2	7.1	3000
	PT19-39		17.0	5.2	7.1	1700
	PP19		4.3	6.1	2.1	705
Polipasto Hook assembly	ST/DR		5.7	2.1	4.4	2300
Carro Trolley	ST/DR		8.5	7.6	7.0	2550
Tirante sostén pluma Jib support tie			31	3.6	2.2	7110
Contrapluma 1 Counterjib 1			37.5	6.7	8.2	20200

LISTA DE EMBARQUE / PACKING LIST

LISTE DE COLISAGE / KOLLI LISTE / СПИСОК ПОСТАВКИ / قائمة التحميل

J560

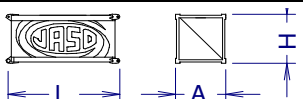
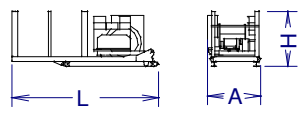
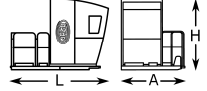
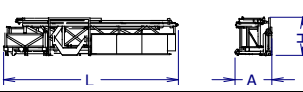
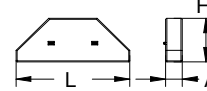
		L [ft]	A [ft]	H [ft]	P / W [lb]
Contrapluma 2 Counterjib 2		14.9	6.7	6.8	4940
Contrapluma 3 con mecanismos (sin cable) y plúmín auxiliar Counterjib 3 with mechanism (without rope), and auxiliary jib		21.0	7.5	8.1	21200
Plataforma y cabina Platform and cabin		12.0	7.5	8.1	2760
Transporte torre de montaje Jacking cage transport	TM20PASR-5,6 	35.5	7.5	7.9	26770
Contrapeso Counterweight	Lastre Ballast 	12.5 12.5 12.5	1.9 0.9 0.6	4.9 4.9 4.9	13200 6600 4400

TREPADO / CLIMBING

J560

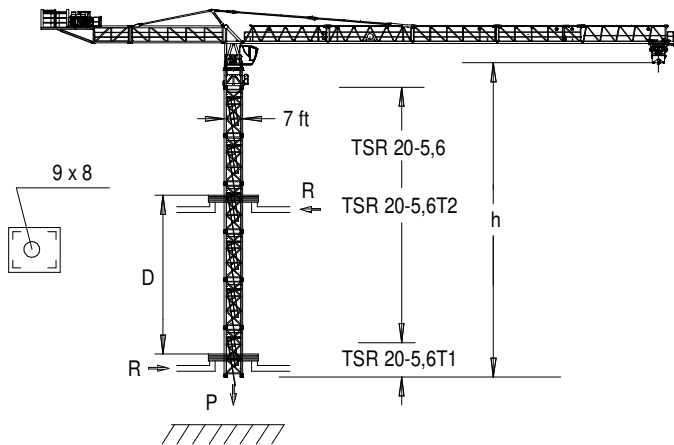

h _{max} : TSR20-5,6T1 + 8 x TSR20-5,6 + TSR20-5,6T2		
	▶	■
h (ft)	197	
D (ft)	47 – 93	
P (lbf)	441700	387800
R _{max} (lbf)	88800	174200
	TSR20-5,6T1: 206.31.400	
	TSR20-5,6T2: 206.31.500	

 Trepado interno / Internal climbing

LASTRES INFERIORES / LOWER BALLASTS

J560

BRI 10-24	H (ft)	262	281	297
	P (lb)	158700	185200	211600
BSRI 8-20-5,6	H (ft)	184	203	237
	P (lb)	211600	238100	264600

H: Altura bajo gancho / Height under hook

Para alturas intermedias tomar el lastre correspondiente a la altura superior / For intermediate heights take the ballast corresponding to the higher height

 Viento fuera de servicio / Out of service wind

 Consultar / Consult

▶ En servicio / In service

■ Fuera de servicio / Out of service



Ctra./ Rd. Madrid – Irún - Km. 415 - 20213 IDIAZABAL (Gipuzkoa) - ESPAÑA / SPAIN
P.O. Box, 23 - 20.200 - BEASAIN - E-mail: jaso@jaso.com
Tel. +34 943 - 18 70 00 • Fax. +34 943 - 18 70 20
www.jaso.com

24/01/2024

 FEM 1001

DELEGACIÓN / DEALER