

GRUA TORRE / TOWER CRANE

GRUE A TOUR / TURMDREHKRAN

БАШЕННЫЙ КРАН / رافعة برجية

J480PA



UNE 58-101
FEM 1001

UNE-EN-ISO 9001

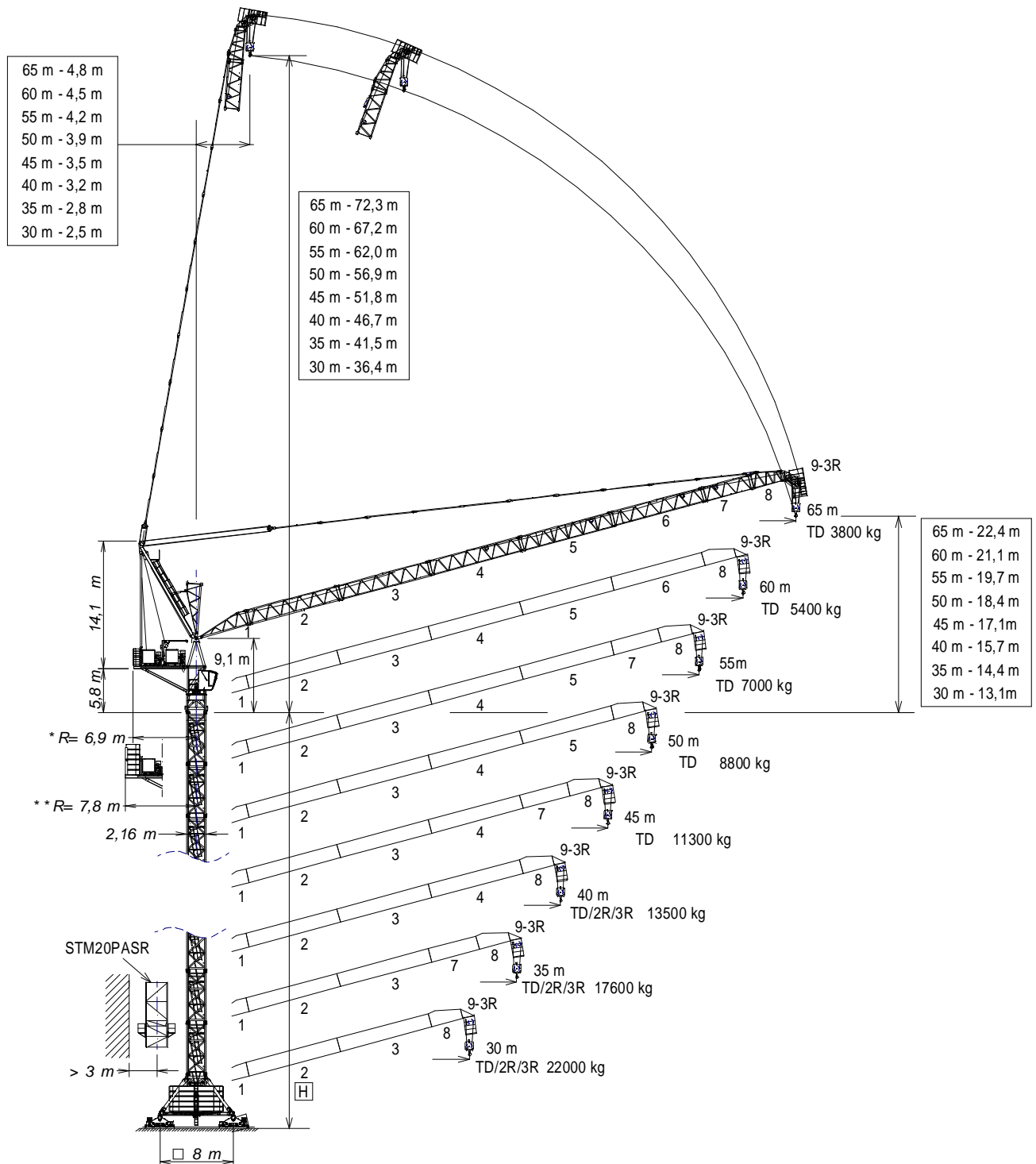

* Contrapesos metálicos / Steel Counterweight

** Contrapesos de hormigón / Concrete counterweights

Tramo pluma / Jib section / Tronçon de fleche

Auslegerabschnitt / Секция стрелы / أجزاء الذراع

Tramo pluma 1 / Jib section 1	206.40.000
Tramo pluma 2 / Jib section 2	206.41.200
Tramo pluma 3 / Jib section 3	206.42.200
Tramo pluma 4 / Jib section 4	206.43.000
Tramo pluma 5 / Jib section 5	206.44.000
Tramo pluma 6 / Jib section 6	206.45.000
Tramo pluma 7 / Jib section 7	206.46.000
Tramo pluma 8 / Jib section 8	206.47.200
Tramo pluma 9-3R / Jib section 9-3R	206.48.000

BSR18-20-5,6	204.20.000
ASR20	160.21.200
TSR20	206.31.200
TSR20-5,6	206.31.000
ABH100C	170.23.000

Fecha / Date: 11/10/2022



Reservado el derecho a modificaciones sin previo aviso. Declinamos toda responsabilidad derivada de la información proporcionada / Subject to modification, without prior notice. This information is supplied without liability / L'entreprise se réserve le droit de procéder à des modifications sans préavis. Nous déclinons toute responsabilité quant aux informations fournies / Das Recht auf Änderungen ohne vorherige Ankündigung bleibt vorbehalten. Wir übernehmen keine Gewähr für die gemachten Angaben / Мы оставляем за собой право на внесение изменений без предварительного уведомления. Мы снимаем с себя любую ответственность в отношении предоставленной информации / حقوق التغيير محفوظة دون إشعار مسبق. دون أدنى مسؤولية عن المعلومات المقدمة



⚙ TD (t)		Cargas máximas / Maximum loads Charges maximales / Höchstlasten / Максимальные нагрузки / أقصى حمولة TD - 12t							
[m]	TD 12t @ (m)	Alcance del gancho [m] / Hook reach [m] / Portée du crochet (m) Reichweite des Hakens (m) / Радиус действия крюка (m) / مدى الخطاف مدى الخطاف							
		30	35	40	45	50	55	60	65
65	41,1	12,0	12,0	12,0	10,1	8,0	6,4	5,0	3,8
60	41,9	12,0	12,0	12,0	10,5	8,5	6,8	5,4	-
55	42,2	12,0	12,0	12,0	10,7	8,6	7,0	-	-
50	42,4	12,0	12,0	12,0	10,8	8,8	-	-	-
45	43,5	12,0	12,0	12,0	11,3	-	-	-	-
40	40,0	12,0	12,0	12,0	-	-	-	-	-
35	35,0	12,0	12,0	-	-	-	-	-	-
30	30,0	12,0	-	-	-	-	-	-	-















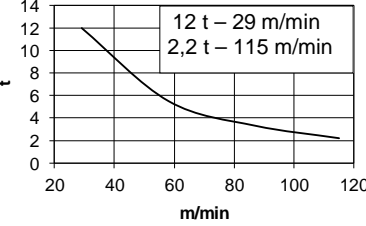
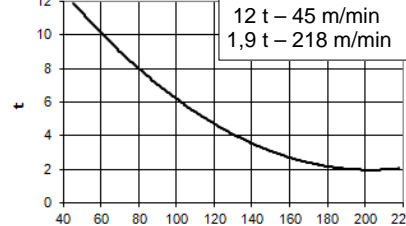

⚙ / ⚙ / ⚙		Cargas máximas / Maximum loads Charges maximales / Höchstlasten / Максимальные нагрузки / أقصى حمولة TD / 2R / 3R (t)												
[m]	3R 36t @ (m)	2R 24t @ (m)	TD 12t @ (m)	Alcance del gancho [m] / Hook reach [m] / Portée du crochet (m) Reichweite des Hakens (m) / Радиус действия крюка (m) / مدى الخطاف مدى الخطاف										
				15	20	25	30	35	40	45	50	55	60	65
65	36t @ (m)	40,3	40,3	12,0	12,0	12,0	12,0	12,0	12,0	9,6	7,6	5,9	4,5	3,3
60		26,4	41,0	24,0	24,0	24,0	19,9	15,6	12,4	9,9	7,9	6,3	4,9	-
55		26,4	41,3	24,0	24,0	24,0	20,0	15,7	12,6	10,1	8,1	6,5	-	-
50	19,3	26,4	41,5	36,0	34,4	25,7	20,0	15,8	12,7	10,2	8,3	-	-	-
45	19,6	26,9	42,5	36,0	35,1	26,4	20,5	16,4	13,2	10,8	-	-	-	-
40	19,7	27,1	40,0	36,0	35,3	26,6	20,8	16,6	13,5	-	-	-	-	-
35	20,2	27,9	35,0	36,0	36,0	27,6	21,8	17,6	-	-	-	-	-	-
30	20,3	28,1	30,0	36,0	36,0	27,9	22,0	-	-	-	-	-	-	-
[m]	2R 18t @ (m)	TD 9t @ (m)	Alcance del gancho [m] / Hook reach [m] / Portée du crochet (m) Reichweite des Hakens (m) / Радиус действия крюка (m) / مدى الخطاف مدى الخطاف											
			25	30	35	40	45	50	55	60	65			
65	31,7	46,4	18,0	18,0	15,3	12,0	9,6	7,6	5,9	4,5	3,3			
[m]	3R 30t @ (m)	2R 20t @ (m)	TD 10t @ (m)	Alcance del gancho [m] / Hook reach [m] / Portée du crochet (m) Reichweite des Hakens (m) / Радиус действия крюка (m) / مدى الخطاف مدى الخطاف										
				20	25	30	35	40	45	50	55			
55	22,4	30,1	45,5	30,0	25,9	20,0	15,7	12,6	10,1	8,1	6,5			

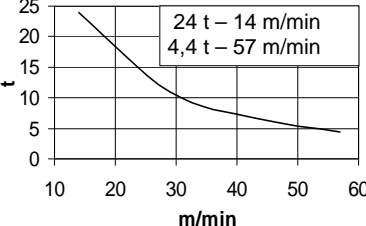
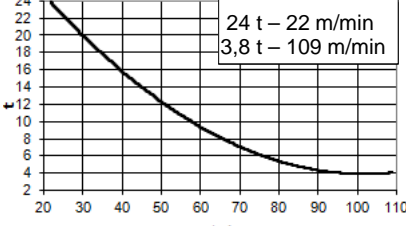
Fecha / Date: 11/10/2022

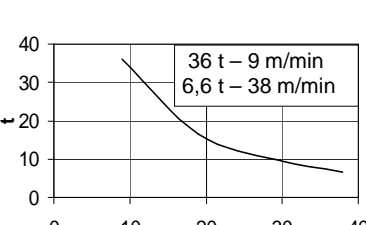
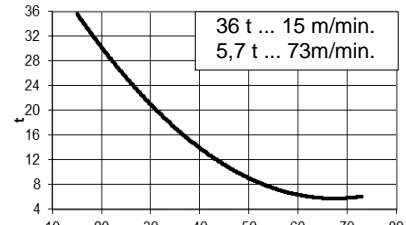
FEM 1001

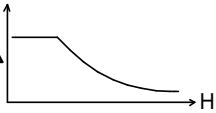

Reservado el derecho a modificaciones sin previo aviso. Declinamos toda responsabilidad derivada de la información proporcionada / Subject to modification, without prior notice. This information is supplied without liability / L'entreprise se réserve le droit de procéder à des modifications sans préavis. Nous déclinons toute responsabilité quant aux informations fournies / Das Recht auf Änderungen ohne vorherige Ankündigung bleibt vorbehalten. Wir übernehmen keine Gewähr für die gemachten Angaben / Мы оставляем за собой право на внесение изменений без предварительного уведомления. Мы снимаем с себя любую ответственность в отношении предоставленной информации / محفوظة دون إشعار مسبق. دون أدنى مسؤولية عن المعلومات المقدمة / حقوق التغيير محفوظة دون إشعار مسبق.

<p>*opcional *optional *en option *optional *опция اختياري*</p>						
	<p>EC88115VF 65 kW</p> 	<p>* EC150218VF 110 kW</p> 	<p>OG2008VF 2x7,3 kW</p> <p>0... 0,8 r/min sl/min</p>	<p>EP10015VF 75 kW</p> <p>1,5 min</p>	<p>TG4025VF 4x7,5 kW</p> <p>0...25 m/min</p>	<p>TH4010 29,4 kW</p> <p>0,6 m/min</p>
			<p> 400V 50Hz</p> <p>P_{TOTAL}(EC88115VF + OG2008VF + EP10015VF) = 154,6 kW P_{TOTAL}(*EC150218VF + OG2008VF + EP10015VF) = *199,6 kW</p>			
			<p>  </p>			
	<p>TD 874m H ≤ 2R 437m 3R 291m</p>	 1129 m	<p> ecoMode</p>			

 Viento fuera de servicio / Out of service wind / Vitesse du vent hors service / Wind außer betrieb / Ветровая нагрузка в покое / الريح خارج الخدمة

 Consultar / Consult / Nous consulter / Anfragen / Консультируйтесь / الرجوع إلى

 En servicio / In service / En service / In betrieb / В работе / في الخدمة

 Fuera de servicio / Out of service / Hors service / Außer betrieb / В покое / خارج الخدمة

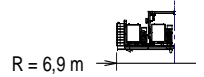

(H) ESTACIONARIA / STATIONARY / STATIONAIRE / STATIONÄR / СТАЦИОНАРНОЕ СОСТОЯНИЕ / ثابتة

TD

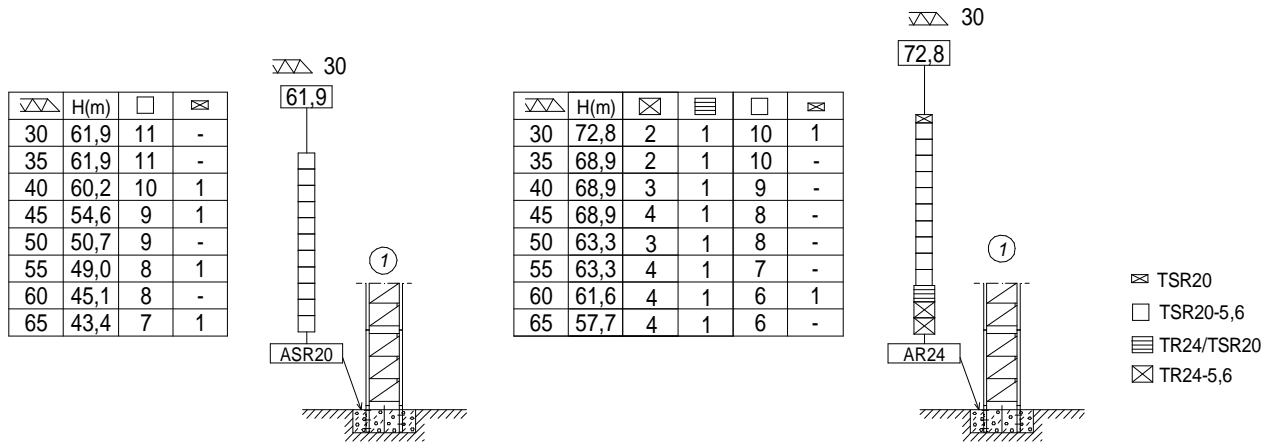

TD / 2R / 3R

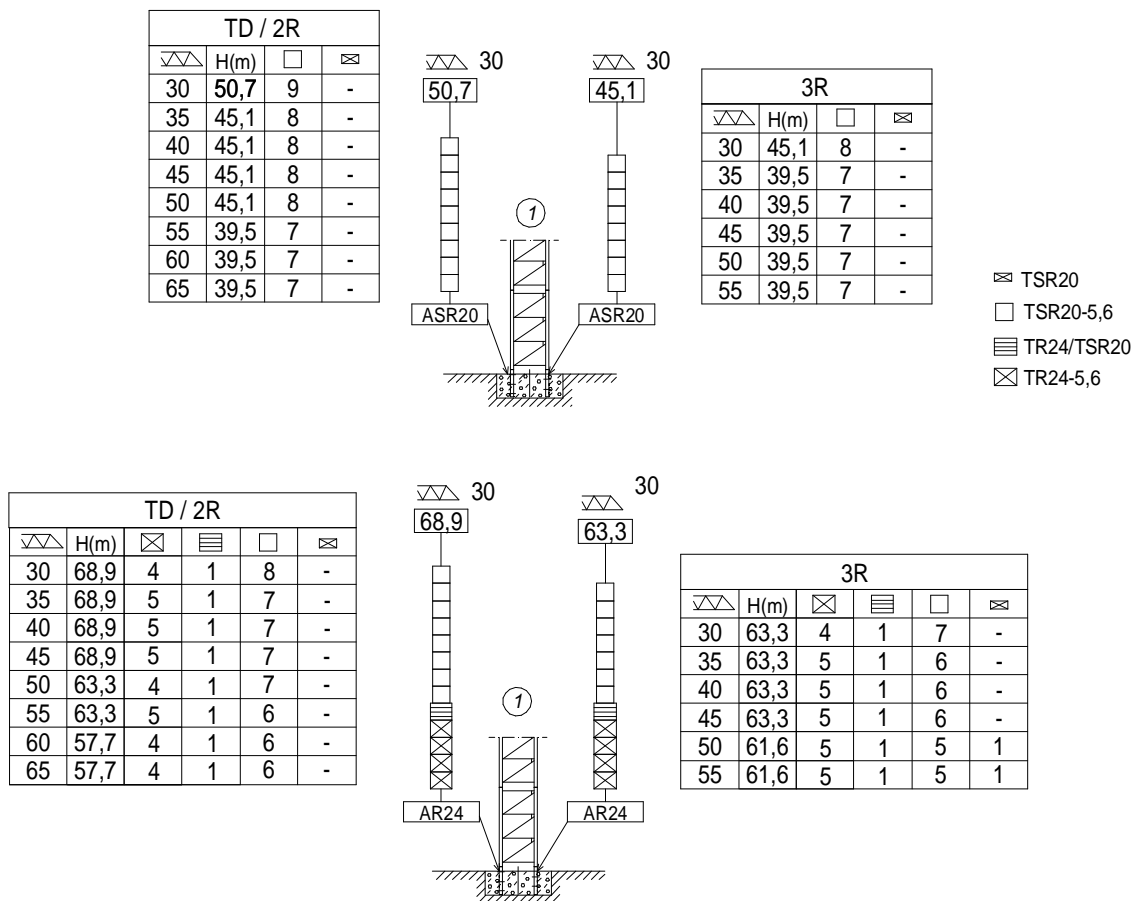

Máxima altura de torre sin arriostrar (m).
 Maximum tower height without fastening (m).
 Hauteur maximale de tour sans ancrage (m).
 Maximale Höhe ohne Verstreben (m).
 Максимальная высота башни без крепления (m).
 أقصى ارتفاع للبرج دون إشراف (م)



Fecha / Date: 11/10/2022

Reservado el derecho a modificaciones sin previo aviso. Declinamos toda responsabilidad derivada de la información proporcionada / Subject to modification, without prior notice. This information is supplied without liability / L'entreprise se réserve le droit de procéder à des modifications sans préavis. Nous déclinons toute responsabilité quant aux informations fournies / Das Recht auf Änderungen ohne vorherige Ankündigung bleibt vorbehalten. Wir übernehmen keine Gewähr für die gemachten Angaben / Мы оставляем за собой право на внесение изменений без предварительного уведомления. Мы снимаем с себя любую ответственность в отношении предоставленной информации / المعلومات المقدمة دون أدنى مسؤولية مسبق. حقوق التغيير محفوظة دون إشعار مسبق.





(H) ESTACIONARIA 3 / STATIONARY 3 / STATIONÄR 3 / STATIONAIRE 3 / СТАЦИОНАРНОЕ СОСТОЯНИЕ / ثابتة

TD	TD / 2R	3R																																																																																																																																
<table border="1" style="margin-top: 10px;"> <thead> <tr> <th>▽▽</th> <th>H(m)</th> <th>□</th> <th>⊠</th> </tr> </thead> <tbody> <tr><td>30</td><td>63,1</td><td>10</td><td>-</td></tr> <tr><td>35</td><td>57,5</td><td>9</td><td>-</td></tr> <tr><td>40</td><td>57,5</td><td>9</td><td>-</td></tr> <tr><td>45</td><td>57,5</td><td>9</td><td>-</td></tr> <tr><td>50</td><td>55,8</td><td>8</td><td>1</td></tr> <tr><td>55</td><td>51,9</td><td>8</td><td>-</td></tr> <tr><td>60</td><td>50,2</td><td>7</td><td>1</td></tr> <tr><td>65</td><td>50,2</td><td>7</td><td>1</td></tr> </tbody> </table>	▽▽	H(m)	□	⊠	30	63,1	10	-	35	57,5	9	-	40	57,5	9	-	45	57,5	9	-	50	55,8	8	1	55	51,9	8	-	60	50,2	7	1	65	50,2	7	1	<table border="1" style="margin-bottom: 10px;"> <thead> <tr> <th>▽▽</th> <th>H(m)</th> <th>□</th> <th>⊠</th> </tr> </thead> <tbody> <tr><td>30</td><td>57,5</td><td>9</td><td>-</td></tr> <tr><td>35</td><td>51,9</td><td>8</td><td>-</td></tr> <tr><td>40</td><td>51,9</td><td>8</td><td>-</td></tr> <tr><td>45</td><td>51,9</td><td>8</td><td>-</td></tr> <tr><td>50</td><td>50,2</td><td>7</td><td>1</td></tr> <tr><td>55</td><td>46,3</td><td>7</td><td>-</td></tr> <tr><td>60</td><td>46,3</td><td>7</td><td>-</td></tr> <tr><td>65</td><td>46,3</td><td>7</td><td>-</td></tr> </tbody> </table> <table border="1" style="margin-top: 10px;"> <thead> <tr> <th>▽▽</th> <th>H(m)</th> <th>□</th> <th>⊠</th> </tr> </thead> <tbody> <tr><td>30</td><td>51,9</td><td>8</td><td>-</td></tr> <tr><td>35</td><td>46,3</td><td>7</td><td>-</td></tr> <tr><td>40</td><td>46,3</td><td>7</td><td>-</td></tr> <tr><td>45</td><td>46,3</td><td>7</td><td>-</td></tr> <tr><td>50</td><td>46,3</td><td>7</td><td>-</td></tr> <tr><td>55</td><td>46,3</td><td>7</td><td>-</td></tr> </tbody> </table>	▽▽	H(m)	□	⊠	30	57,5	9	-	35	51,9	8	-	40	51,9	8	-	45	51,9	8	-	50	50,2	7	1	55	46,3	7	-	60	46,3	7	-	65	46,3	7	-	▽▽	H(m)	□	⊠	30	51,9	8	-	35	46,3	7	-	40	46,3	7	-	45	46,3	7	-	50	46,3	7	-	55	46,3	7	-	<table border="1" style="margin-bottom: 10px;"> <thead> <tr> <th>▽▽</th> <th>H(m)</th> <th>□</th> <th>⊠</th> </tr> </thead> <tbody> <tr><td>30</td><td>51,9</td><td>8</td><td>-</td></tr> <tr><td>35</td><td>46,3</td><td>7</td><td>-</td></tr> <tr><td>40</td><td>46,3</td><td>7</td><td>-</td></tr> <tr><td>45</td><td>46,3</td><td>7</td><td>-</td></tr> <tr><td>50</td><td>46,3</td><td>7</td><td>-</td></tr> <tr><td>55</td><td>46,3</td><td>7</td><td>-</td></tr> </tbody> </table>	▽▽	H(m)	□	⊠	30	51,9	8	-	35	46,3	7	-	40	46,3	7	-	45	46,3	7	-	50	46,3	7	-	55	46,3	7	-
▽▽	H(m)	□	⊠																																																																																																																															
30	63,1	10	-																																																																																																																															
35	57,5	9	-																																																																																																																															
40	57,5	9	-																																																																																																																															
45	57,5	9	-																																																																																																																															
50	55,8	8	1																																																																																																																															
55	51,9	8	-																																																																																																																															
60	50,2	7	1																																																																																																																															
65	50,2	7	1																																																																																																																															
▽▽	H(m)	□	⊠																																																																																																																															
30	57,5	9	-																																																																																																																															
35	51,9	8	-																																																																																																																															
40	51,9	8	-																																																																																																																															
45	51,9	8	-																																																																																																																															
50	50,2	7	1																																																																																																																															
55	46,3	7	-																																																																																																																															
60	46,3	7	-																																																																																																																															
65	46,3	7	-																																																																																																																															
▽▽	H(m)	□	⊠																																																																																																																															
30	51,9	8	-																																																																																																																															
35	46,3	7	-																																																																																																																															
40	46,3	7	-																																																																																																																															
45	46,3	7	-																																																																																																																															
50	46,3	7	-																																																																																																																															
55	46,3	7	-																																																																																																																															
▽▽	H(m)	□	⊠																																																																																																																															
30	51,9	8	-																																																																																																																															
35	46,3	7	-																																																																																																																															
40	46,3	7	-																																																																																																																															
45	46,3	7	-																																																																																																																															
50	46,3	7	-																																																																																																																															
55	46,3	7	-																																																																																																																															

⊠ TSR20
 □ TSR20-5,6

(H) TRASLACIÓN / TRAVELLING / TRASLATION / FORTBEWEGUNG / ПЕРЕМЕЩЕНИЕ / متحركة

TD	TD / 2R / 3R	3R																																																																																																																																
<table border="1" style="margin-top: 10px;"> <thead> <tr> <th>▽▽</th> <th>H(m)</th> <th>□</th> <th>⊠</th> </tr> </thead> <tbody> <tr><td>30</td><td>63,8</td><td>10</td><td>-</td></tr> <tr><td>35</td><td>58,2</td><td>9</td><td>-</td></tr> <tr><td>40</td><td>58,2</td><td>9</td><td>-</td></tr> <tr><td>45</td><td>58,2</td><td>9</td><td>-</td></tr> <tr><td>50</td><td>56,5</td><td>8</td><td>1</td></tr> <tr><td>55</td><td>52,6</td><td>8</td><td>-</td></tr> <tr><td>60</td><td>50,9</td><td>7</td><td>1</td></tr> <tr><td>65</td><td>50,9</td><td>7</td><td>1</td></tr> </tbody> </table>	▽▽	H(m)	□	⊠	30	63,8	10	-	35	58,2	9	-	40	58,2	9	-	45	58,2	9	-	50	56,5	8	1	55	52,6	8	-	60	50,9	7	1	65	50,9	7	1	<table border="1" style="margin-bottom: 10px;"> <thead> <tr> <th>▽▽</th> <th>H(m)</th> <th>□</th> <th>⊠</th> </tr> </thead> <tbody> <tr><td>30</td><td>58,2</td><td>9</td><td>-</td></tr> <tr><td>35</td><td>52,6</td><td>8</td><td>-</td></tr> <tr><td>40</td><td>52,6</td><td>8</td><td>-</td></tr> <tr><td>45</td><td>52,6</td><td>8</td><td>-</td></tr> <tr><td>50</td><td>50,9</td><td>7</td><td>1</td></tr> <tr><td>55</td><td>47,0</td><td>7</td><td>-</td></tr> <tr><td>60</td><td>47,0</td><td>7</td><td>-</td></tr> <tr><td>65</td><td>47,0</td><td>7</td><td>-</td></tr> </tbody> </table> <table border="1" style="margin-top: 10px;"> <thead> <tr> <th>▽▽</th> <th>H(m)</th> <th>□</th> <th>⊠</th> </tr> </thead> <tbody> <tr><td>30</td><td>52,6</td><td>8</td><td>-</td></tr> <tr><td>35</td><td>47,0</td><td>7</td><td>-</td></tr> <tr><td>40</td><td>47,0</td><td>7</td><td>-</td></tr> <tr><td>45</td><td>47,0</td><td>7</td><td>-</td></tr> <tr><td>50</td><td>47,0</td><td>7</td><td>-</td></tr> <tr><td>55</td><td>47,0</td><td>7</td><td>-</td></tr> </tbody> </table>	▽▽	H(m)	□	⊠	30	58,2	9	-	35	52,6	8	-	40	52,6	8	-	45	52,6	8	-	50	50,9	7	1	55	47,0	7	-	60	47,0	7	-	65	47,0	7	-	▽▽	H(m)	□	⊠	30	52,6	8	-	35	47,0	7	-	40	47,0	7	-	45	47,0	7	-	50	47,0	7	-	55	47,0	7	-	<table border="1" style="margin-bottom: 10px;"> <thead> <tr> <th>▽▽</th> <th>H(m)</th> <th>□</th> <th>⊠</th> </tr> </thead> <tbody> <tr><td>30</td><td>52,6</td><td>8</td><td>-</td></tr> <tr><td>35</td><td>47,0</td><td>7</td><td>-</td></tr> <tr><td>40</td><td>47,0</td><td>7</td><td>-</td></tr> <tr><td>45</td><td>47,0</td><td>7</td><td>-</td></tr> <tr><td>50</td><td>47,0</td><td>7</td><td>-</td></tr> <tr><td>55</td><td>47,0</td><td>7</td><td>-</td></tr> </tbody> </table>	▽▽	H(m)	□	⊠	30	52,6	8	-	35	47,0	7	-	40	47,0	7	-	45	47,0	7	-	50	47,0	7	-	55	47,0	7	-
▽▽	H(m)	□	⊠																																																																																																																															
30	63,8	10	-																																																																																																																															
35	58,2	9	-																																																																																																																															
40	58,2	9	-																																																																																																																															
45	58,2	9	-																																																																																																																															
50	56,5	8	1																																																																																																																															
55	52,6	8	-																																																																																																																															
60	50,9	7	1																																																																																																																															
65	50,9	7	1																																																																																																																															
▽▽	H(m)	□	⊠																																																																																																																															
30	58,2	9	-																																																																																																																															
35	52,6	8	-																																																																																																																															
40	52,6	8	-																																																																																																																															
45	52,6	8	-																																																																																																																															
50	50,9	7	1																																																																																																																															
55	47,0	7	-																																																																																																																															
60	47,0	7	-																																																																																																																															
65	47,0	7	-																																																																																																																															
▽▽	H(m)	□	⊠																																																																																																																															
30	52,6	8	-																																																																																																																															
35	47,0	7	-																																																																																																																															
40	47,0	7	-																																																																																																																															
45	47,0	7	-																																																																																																																															
50	47,0	7	-																																																																																																																															
55	47,0	7	-																																																																																																																															
▽▽	H(m)	□	⊠																																																																																																																															
30	52,6	8	-																																																																																																																															
35	47,0	7	-																																																																																																																															
40	47,0	7	-																																																																																																																															
45	47,0	7	-																																																																																																																															
50	47,0	7	-																																																																																																																															
55	47,0	7	-																																																																																																																															

⊠ TSR20
 □ TSR20-5,6

Mxima altura de torre sin arristrar (m).
 Maximum tower height without fastening (m).
 Hauteur maximale de tour sans ancrage (m).
 Maximale Hhe ohne Verstreben (m)
 Максимальная высота башни без крепления (m).
 H = أقصى ارتفاع للبرج دون ربط (م)



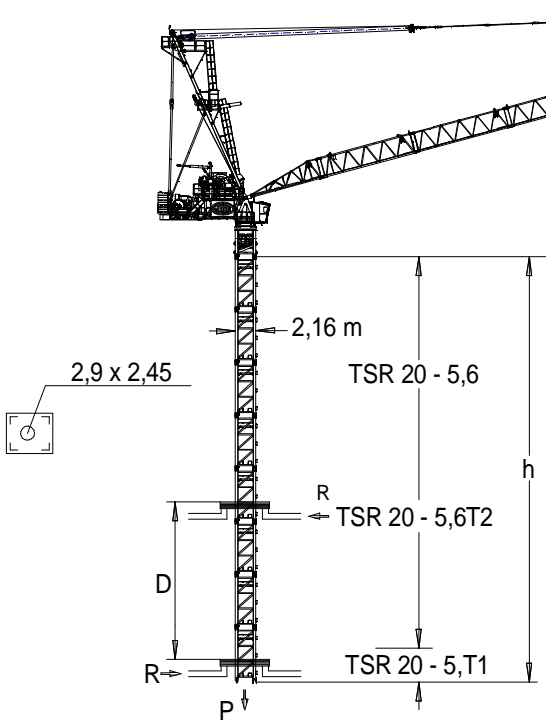
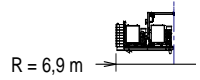

h_{max} : TSR20-5,6T1 + 5 x TSR20-5,6 + TSR 20-5,6T2 + TSR20

	TD 12 t	▶	■
h (m)	43,1		
D (m)	20 – 14,3		
P (KN)	1785	1665	
Rmax (KN)	470	790	

h_{max} : TSR20-5,6T1 + 5 x TSR 20-5,6 + TSR 20-5,6T2

	TD/2R/3R TD/2R 24 t	▶	■
h (m)	39,2		
D (m)	18 – 15,6		
P (KN)	1865	1625	
Rmax (KN)	450	670	

h_{max} : TSR20-5,6T1 + 5 x TSR20-5,6 + TSR20-5,6T2

	TD/2R/3R 3R 36 t	▶	■
h (m)	39,2		
D (m)	18 – 14,8		
P (KN)	1960	1600	
Rmax (KN)	470	695	

TSR20-5,6T1: 206.31.400
TSR20-5,6T2: 206.31.500



Trepado interno / Internal climbing
Télescopage intérieur / Inneres Klettersystem
Внутренняя лестница / التسلق الداخلي

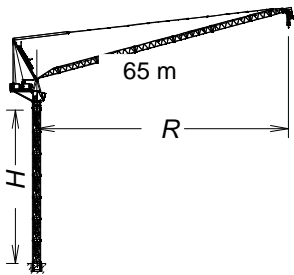
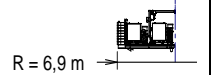

H = 39,5 m + + ASRD20/24

8 x

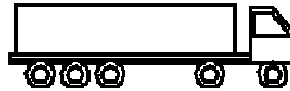

7 x HIGH CUBE 40'

1 x OPEN TOP 40'



Fecha / Date: 11/10/2022

FEM 1001

Reservado el derecho a modificaciones sin previo aviso. Declinamos toda responsabilidad derivada de la información proporcionada / Subject to modification, without prior notice. This information is supplied without liability / L'entreprise se réserve le droit de procéder à des modifications sans préavis. Nous déclinons toute responsabilité quant aux informations fournies / Das Recht auf Änderungen ohne vorherige Ankündigung bleibt vorbehalten. Wir übernehmen keine Gewähr für die gemachten Angaben / Мы оставляем за собой право на внесение изменений без предварительного уведомления. Мы снимаем с себя любую ответственность в отношении предоставленной информации / المعلومات المقدمة / دون أدنى مسؤولية عن المعلومات المقدمة / حقوق التغيير محفوظة دون إشعار مسبق.

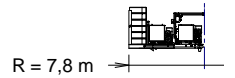

(H) ESTACIONARIA / STATIONARY / STATIONAIRE / STATIONÄR / СТАЦИОНАРНОЕ СОСТОЯНИЕ / ثابتة

TD

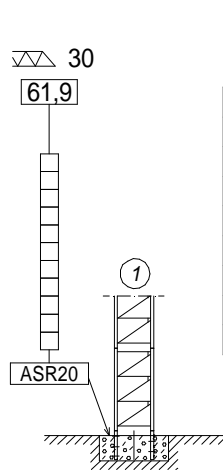

▽▽	H(m)	□	⊠
30	61,9	11	-
35	61,9	11	-
40	60,2	10	1
45	50,7	9	-
50	50,7	9	-
55	45,1	8	-
60	45,1	8	-
65	39,5	7	-

▽▽	H(m)	⊠	▨	□	⊠
30	72,8	2	1	10	1
35	68,9	2	1	10	-
40	68,9	3	1	9	-
45	67,2	4	1	7	1
50	63,3	4	1	7	-
55	61,6	5	1	5	1
60	57,7	4	1	6	-
65	57,7	4	1	6	-

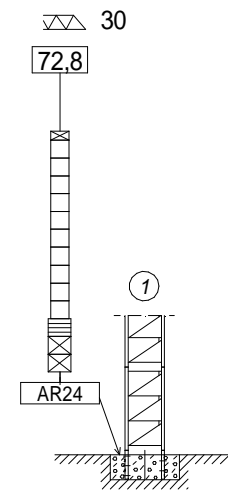

- ⊠ TSR20
- TSR20-5,6
- ▨ TR24/TSR20
- ⊠ TR24-5,6

TD / 2R / 3R

TD / 2R			
▽▽	H(m)	□	⊠
30	49,0	8	1
35	45,1	8	-
40	45,1	8	-
45	45,1	8	-
50	45,1	8	-
55	39,5	7	-
60	37,8	6	1
65	37,8	6	1

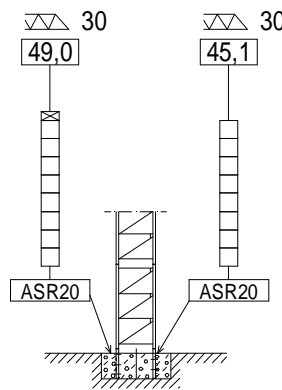

3R			
▽▽	H(m)	□	⊠
30	45,1	8	-
35	39,5	7	-
40	39,5	7	-
45	39,5	7	-
50	39,5	7	-
55	39,5	7	-

- ⊠ TSR20
- TSR20-5,6
- ▨ TR24/TSR20
- ⊠ TR24-5,6

TD / 2R					
▽▽	H(m)	⊠	▨	□	⊠
30	68,9	5	1	7	-
35	68,9	5	1	7	-
40	68,9	5	1	7	-
45	67,2	5	1	6	1
50	63,3	4	1	7	-
55	61,6	5	1	5	1
60	57,7	4	1	6	-
65	56,0	4	1	5	1

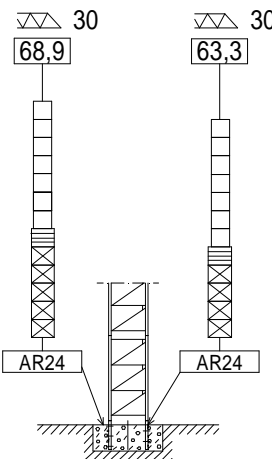

3R					
▽▽	H(m)	⊠	▨	□	⊠
30	63,3	4	1	7	-
35	63,3	5	1	6	-
40	63,3	5	1	6	-
45	61,6	5	1	5	1
50	61,6	5	1	5	1
55	61,6	5	1	5	1

Máxima altura de torre sin arriostrar (m).
 Maximum tower height without fastening (m).
 Hauteur maximale de tour sans ancrage (m).
 Maximale Höhe ohne Verstreben (m).
 Максимальная высота башни без крепления (м).
 أقصى ارتفاع للبرج دون ربط (م)

Fecha / Date: 11/10/2022

FEM 1001



Reservado el derecho a modificaciones sin previo aviso. Declinamos toda responsabilidad derivada de la información proporcionada / Subject to modification, without prior notice. This information is supplied without liability / L'entreprise se réserve le droit de procéder à des modifications sans préavis. Nous déclinons toute responsabilité quant aux informations fournies / Das Recht auf Änderungen ohne vorherige Ankündigung bleibt vorbehalten. Wir übernehmen keine Gewähr für die gemachten Angaben / Мы оставляем за собой право на внесение изменений без предварительного уведомления. Мы снимаем с себя любую ответственность в отношении предоставленной информации / المعلومات المقدمة دون أدنى مسؤولية عن المعلومات المقدمة. دون أدنى مسؤولية مسبق. حقوق التغيير محفوظة دون إشعار مسبق.

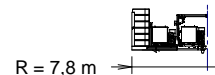

(H) ESTACIONARIA 3 / STATIONARY 3 / STATIONÄR 3 / STATIONAIRE 3 / СТАЦИОНАРНОЕ СОСТОЯНИЕ / ثابتة

TD		TD/2R/3R																																																																																																												
<table border="1"> <thead> <tr> <th>▽▽</th> <th>H(m)</th> <th>□</th> <th>⊠</th> </tr> </thead> <tbody> <tr><td>30</td><td>57,5</td><td>9</td><td>-</td></tr> <tr><td>35</td><td>57,5</td><td>9</td><td>-</td></tr> <tr><td>40</td><td>55,8</td><td>8</td><td>1</td></tr> <tr><td>45</td><td>55,8</td><td>8</td><td>1</td></tr> <tr><td>50</td><td>55,8</td><td>8</td><td>1</td></tr> <tr><td>55</td><td>51,9</td><td>8</td><td>-</td></tr> <tr><td>60</td><td>50,2</td><td>7</td><td>1</td></tr> <tr><td>65</td><td>44,6</td><td>6</td><td>1</td></tr> </tbody> </table>	▽▽	H(m)	□	⊠	30	57,5	9	-	35	57,5	9	-	40	55,8	8	1	45	55,8	8	1	50	55,8	8	1	55	51,9	8	-	60	50,2	7	1	65	44,6	6	1	<table border="1"> <thead> <tr> <th colspan="4">TD / 2R</th> </tr> <tr> <th>▽▽</th> <th>H(m)</th> <th>□</th> <th>⊠</th> </tr> </thead> <tbody> <tr><td>30</td><td>51,9</td><td>8</td><td>-</td></tr> <tr><td>35</td><td>51,9</td><td>8</td><td>-</td></tr> <tr><td>40</td><td>51,9</td><td>8</td><td>-</td></tr> <tr><td>45</td><td>51,9</td><td>8</td><td>-</td></tr> <tr><td>50</td><td>51,9</td><td>8</td><td>-</td></tr> <tr><td>55</td><td>46,3</td><td>7</td><td>-</td></tr> <tr><td>60</td><td>44,6</td><td>6</td><td>1</td></tr> <tr><td>65</td><td>44,6</td><td>6</td><td>1</td></tr> </tbody> </table>	TD / 2R				▽▽	H(m)	□	⊠	30	51,9	8	-	35	51,9	8	-	40	51,9	8	-	45	51,9	8	-	50	51,9	8	-	55	46,3	7	-	60	44,6	6	1	65	44,6	6	1	<table border="1"> <thead> <tr> <th colspan="4">3R</th> </tr> <tr> <th>▽▽</th> <th>H(m)</th> <th>□</th> <th>⊠</th> </tr> </thead> <tbody> <tr><td>30</td><td>51,9</td><td>8</td><td>-</td></tr> <tr><td>35</td><td>46,3</td><td>7</td><td>-</td></tr> <tr><td>40</td><td>46,3</td><td>7</td><td>-</td></tr> <tr><td>45</td><td>46,3</td><td>7</td><td>-</td></tr> <tr><td>50</td><td>46,3</td><td>7</td><td>-</td></tr> <tr><td>55</td><td>46,3</td><td>7</td><td>-</td></tr> </tbody> </table>	3R				▽▽	H(m)	□	⊠	30	51,9	8	-	35	46,3	7	-	40	46,3	7	-	45	46,3	7	-	50	46,3	7	-	55	46,3	7	-
▽▽	H(m)	□	⊠																																																																																																											
30	57,5	9	-																																																																																																											
35	57,5	9	-																																																																																																											
40	55,8	8	1																																																																																																											
45	55,8	8	1																																																																																																											
50	55,8	8	1																																																																																																											
55	51,9	8	-																																																																																																											
60	50,2	7	1																																																																																																											
65	44,6	6	1																																																																																																											
TD / 2R																																																																																																														
▽▽	H(m)	□	⊠																																																																																																											
30	51,9	8	-																																																																																																											
35	51,9	8	-																																																																																																											
40	51,9	8	-																																																																																																											
45	51,9	8	-																																																																																																											
50	51,9	8	-																																																																																																											
55	46,3	7	-																																																																																																											
60	44,6	6	1																																																																																																											
65	44,6	6	1																																																																																																											
3R																																																																																																														
▽▽	H(m)	□	⊠																																																																																																											
30	51,9	8	-																																																																																																											
35	46,3	7	-																																																																																																											
40	46,3	7	-																																																																																																											
45	46,3	7	-																																																																																																											
50	46,3	7	-																																																																																																											
55	46,3	7	-																																																																																																											
			<p>⊠ TSR20 □ TSR20-5,6</p>																																																																																																											

(H) TRASLACIÓN / TRAVELLING / TRASLATION / FORTBEWEGUNG / ПЕРЕМЕЩЕНИЕ / متحركة

TD		TD / 2R / 3R																																																																																																												
<table border="1"> <thead> <tr> <th>▽▽</th> <th>H(m)</th> <th>□</th> <th>⊠</th> </tr> </thead> <tbody> <tr><td>30</td><td>58,2</td><td>9</td><td>-</td></tr> <tr><td>35</td><td>58,2</td><td>9</td><td>-</td></tr> <tr><td>40</td><td>56,5</td><td>8</td><td>1</td></tr> <tr><td>45</td><td>56,5</td><td>8</td><td>1</td></tr> <tr><td>50</td><td>56,5</td><td>8</td><td>1</td></tr> <tr><td>55</td><td>52,6</td><td>8</td><td>-</td></tr> <tr><td>60</td><td>50,9</td><td>7</td><td>1</td></tr> <tr><td>65</td><td>45,3</td><td>6</td><td>1</td></tr> </tbody> </table>	▽▽	H(m)	□	⊠	30	58,2	9	-	35	58,2	9	-	40	56,5	8	1	45	56,5	8	1	50	56,5	8	1	55	52,6	8	-	60	50,9	7	1	65	45,3	6	1	<table border="1"> <thead> <tr> <th colspan="4">TD / 2R</th> </tr> <tr> <th>▽▽</th> <th>H(m)</th> <th>□</th> <th>⊠</th> </tr> </thead> <tbody> <tr><td>30</td><td>52,6</td><td>8</td><td>-</td></tr> <tr><td>35</td><td>52,6</td><td>8</td><td>-</td></tr> <tr><td>40</td><td>52,6</td><td>8</td><td>-</td></tr> <tr><td>45</td><td>52,6</td><td>8</td><td>-</td></tr> <tr><td>50</td><td>52,6</td><td>8</td><td>-</td></tr> <tr><td>55</td><td>47,0</td><td>7</td><td>-</td></tr> <tr><td>60</td><td>45,3</td><td>6</td><td>1</td></tr> <tr><td>65</td><td>45,3</td><td>6</td><td>1</td></tr> </tbody> </table>	TD / 2R				▽▽	H(m)	□	⊠	30	52,6	8	-	35	52,6	8	-	40	52,6	8	-	45	52,6	8	-	50	52,6	8	-	55	47,0	7	-	60	45,3	6	1	65	45,3	6	1	<table border="1"> <thead> <tr> <th colspan="4">3R</th> </tr> <tr> <th>▽▽</th> <th>H(m)</th> <th>□</th> <th>⊠</th> </tr> </thead> <tbody> <tr><td>30</td><td>52,6</td><td>8</td><td>-</td></tr> <tr><td>35</td><td>47,0</td><td>7</td><td>-</td></tr> <tr><td>40</td><td>47,0</td><td>7</td><td>-</td></tr> <tr><td>45</td><td>47,0</td><td>7</td><td>-</td></tr> <tr><td>50</td><td>47,0</td><td>7</td><td>-</td></tr> <tr><td>55</td><td>47,0</td><td>7</td><td>-</td></tr> </tbody> </table>	3R				▽▽	H(m)	□	⊠	30	52,6	8	-	35	47,0	7	-	40	47,0	7	-	45	47,0	7	-	50	47,0	7	-	55	47,0	7	-
▽▽	H(m)	□	⊠																																																																																																											
30	58,2	9	-																																																																																																											
35	58,2	9	-																																																																																																											
40	56,5	8	1																																																																																																											
45	56,5	8	1																																																																																																											
50	56,5	8	1																																																																																																											
55	52,6	8	-																																																																																																											
60	50,9	7	1																																																																																																											
65	45,3	6	1																																																																																																											
TD / 2R																																																																																																														
▽▽	H(m)	□	⊠																																																																																																											
30	52,6	8	-																																																																																																											
35	52,6	8	-																																																																																																											
40	52,6	8	-																																																																																																											
45	52,6	8	-																																																																																																											
50	52,6	8	-																																																																																																											
55	47,0	7	-																																																																																																											
60	45,3	6	1																																																																																																											
65	45,3	6	1																																																																																																											
3R																																																																																																														
▽▽	H(m)	□	⊠																																																																																																											
30	52,6	8	-																																																																																																											
35	47,0	7	-																																																																																																											
40	47,0	7	-																																																																																																											
45	47,0	7	-																																																																																																											
50	47,0	7	-																																																																																																											
55	47,0	7	-																																																																																																											
			<p>⊠ TSR20 □ TSR20-5,6</p>																																																																																																											

H = Máxima altura de torre sin arriostrar (m).
 Maximum tower height without fastening (m).
 Hauteur maximale de tour sans ancrage (m).
 Maximale Höhe ohne Verstreben (m).
 Максимальная высота башни без крепления (м).
 أقصى ارتفاع للبرج دون ربط (م)



Fecha / Date: 11/10/2022

FEM 1001

Reservado el derecho a modificaciones sin previo aviso. Declinamos toda responsabilidad derivada de la información proporcionada / Subject to modification, without prior notice. This information is supplied without liability / L'entreprise se réserve le droit de procéder à des modifications sans préavis. Nous déclinons toute responsabilité quant aux informations fournies / Das Recht auf Änderungen ohne vorherige Ankündigung bleibt vorbehalten. Wir übernehmen keine Gewähr für die gemachten Angaben / Мы оставляем за собой право на внесение изменений без предварительного уведомления. Мы снимаем с себя любую ответственность в отношении предоставленной информации / المعلومات المقدمة / دون أدنى مسؤولية عن المعلومات المقدمة / حقوق التغيير محفوظة دون إشعار مسبق.

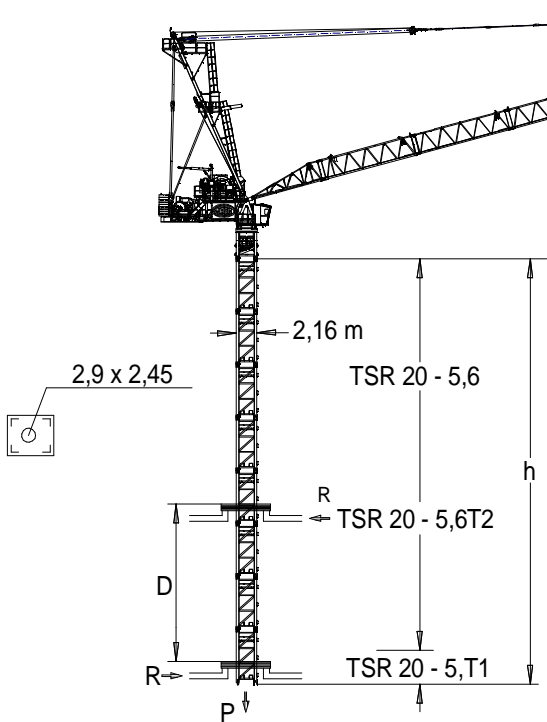
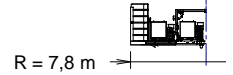

TSR20-5,6T1: 206.31.400
 TSR20-5,6T2: 206.31.500

i Trepado interno / Internal climbing
 Téléscopage intérieur / Inneres klettersystem
 Внутренняя лестница / التسلق الداخلي

h_{max} : TSR20-5,6T1 + 5 x TSR20-5,6 + TSR 20-5,6T2

	TD 12 t	▶	■
h (m)	39,2		
D (m)	18 - 13,3		
P (kN)	1730	1610	
Rmax (kN)	495	780	

h_{max} : TSR20-5,6T1 + 4 x TSR 20-5,6 + TSR 20-5,6T2 + TSR20

	TD/2R/3R TD/2R 24 t	▶	■
h (m)	37,5		
D (m)	17 - 15,1		
P (kN)	1835	1595	
Rmax (kN)	460	675	

h_{max} : TSR20-5,6T1 + 5 x TSR20-5,6 + TSR20-5,6T2

	TD/2R/3R 3R 36 t	▶	■
h (m)	39,2		
D (m)	18 - 13,8		
P (kN)	1870	1510	
Rmax (kN)	490	690	

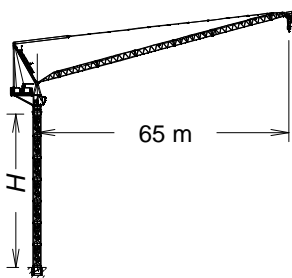
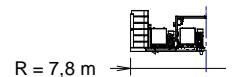

H = 39,5 m +  + ASRD20/24



9 x HIGH CUBE 40'

1 x OPEN TOP 40'



Fecha / Date: 11/10/2022

 FEM 1001

Reservado el derecho a modificaciones sin previo aviso. Declinamos toda responsabilidad derivada de la información proporcionada / Subject to modification, without prior notice. This information is supplied without liability / L'entreprise se réserve le droit de procéder à des modifications sans préavis. Nous déclinons toute responsabilité quant aux informations fournies / Das Recht auf Änderungen ohne vorherige Ankündigung bleibt vorbehalten. Wir übernehmen keine Gewähr für die gemachten Angaben / Мы оставляем за собой право на внесение изменений без предварительного уведомления. Мы снимаем с себя любую ответственность в отношении предоставленной информации / حقوق التغيير محفوظة دون إشعار مسبق. دون أدنى مسؤولية عن المعلومات المقدمة

LISTA DE EMBARQUE / PACKING LIST / LISTE DE COLISAGE / KOLLI LISTE / СПИСОК ПОСТАВКИ / قائمة التحميل **J480PA**

DENOMINACIÓN / DENOMINATION / DÉSIGNATION / BEZEICHNUNG / НАЗВАНИЕ / اسم		L [m]	A [m]	H [m]	P / W [kg]
Torre inferior / Lower tower Tour inférieure / Unterer Turm Нижняя башня / البرج السفلي	TSRI-20-5,6				
		5,990	2,257	2,257	6562
Torre / Tower Tour / Turm / Башня / برج	TSR20 TSR20-5,6				
		4,260	2,251	2,251	3110
		5,990	2,257	2,257	4210
Torre asiento pista, torre superior y orientación Slewing table, top tower and slewing mechanism Tour pivot + tour supérieure + mécanisme d'orientation Turmsitz, + oberer Turm + Ausrichtung Сиденье площадки + верхняя башня + поворотный механизм					
		9,650	2,320	2,560	15825
Punta de torre / Top tower Tour supérieure / Turmspitze / верхняя башня / رأس البرج					
		5,860	2,280	2,380	5300
Torre asiento pista + base punta de torre + orientación Slewing table + tower head base + slewing mechanism Tour pivot + base du porte-flèche + mécanisme d'orientation Turmsitz + Turmspitzenbasis + Ausrichtung Сиденье площадки + основание верхней секции башни + поворотный механизм					
		4,660	2,560	2,460	10525
برج وحدة الدوران + البرج العلوي + آلية الدوران					
Tramo de pluma Jib section Tronçon de flèche Auslegerabschnitt Секция стрелы أجزاء الذراع	[1] [2] [3] [4] [5] [6] [7] [8] [9-3R]				
		6,265	2,200	1,783	1830
		10,460	1,560	1,750	2710
		10,505	1,560	1,748	2630
		10,550	1,540	1,752	2295
		10,550	1,490	1,730	1890
		10,550	1,540	1,725	1745
		5,615	1,540	1,725	980
		3,780	1,540	1,855	995
		2,370	1,970	3,17	1105
Contrapluma con mecanismos, pasteca y plumin Counterjib with mechanisms, reeving block and auxiliary jib Contre-flèche avec mécanismes et fléchette auxiliaire Gegenausleger + Mechanismus + Unterflasche + Ausleger Противовесная консоль с механизмами и вспомогательной					
الذراع المعاكس مع البيت وريشة مساعدة					
		7,300	2,241	2,495	19600
Contrapluma con elevacion pluma, pasteca y plumin Counterjib+ luffing mechanisms+ reeving block+ auxiliary jib Contre-flèche avec mécanisme de relevage de la flèche, moufle et fléchette Gegenausleger + Auslegerhebewerk + Unterflasche + Ausleger Противовесная консоль с механизмом подъема стрелы, блоком и дополнительной стрелой					
الذراع المعاكس مع رافع الذراع والبكرة والريشة الاضافية					
		7,300	2,218	2,495	12700
Mecanismo elevacion carga / Hoisting mechanism Mécanisme de levage de charge / Lasthubmechanismus Подъем груза / رافع الحمولة					
		2,208	2,539	2,068	6900
Polipasto / Hook assembly Palan / Flaschenzug / Полуспаст / ككرة	TD/2R/3R TD				
		1,101	0,340	1,692	800
		0,150	0,278	1,715	240
Tirante sostén pluma / Jib support tie / Tirant de fleche Haltestange Ausleger / Растяжка поддержки стрелы مشد دعامة الذراع					
		5,850	0,430	0,615	2375
Parte superior / Top part / Partie supérieure / Oberteil					
		11,947	2,222	0,878	6970
Plataforma y cabina (2 x 1,5) / Platform and cabin / Plateforme et cabin / Plattform + Führerstand / Платформа и кабина / منصة وكابينة					
		3,670	2,300	2,480	1250
Transporte torre de montaje / Jacking cage transport Transport de tour de montage Transport Montageturm / Транспортировка монтажной башни / نقل آراج التركيب	TM20PASR-5,6				
		10,820	2,285	2,395	12140
Contrapeso / Counterweight Contrepoids / Gegengewichte / Противовес / اوزان معاكسة					
		2,200	0,340	0,830	3000
		4,500	0,340	0,830	6000
Contrapeso / Counterweight Contrepoids / Gegengewichte Противовес / اوزان معاكسة	Lastre / Ballast Lest / Ballast / Балласт / نقل				
		3,800	0,275	1,500	3000
		3,800	0,580	1,500	6000



Ctra./Rd. Madrid - Irún Km. 415 - 20.213 IDIAZABAL [Gipuzkoa] ESPAÑA / SPAIN
P.O. Box, 23 - 20.200 BEASAIN - E-mail: jaso@jaso.com
Tel. +34 943 - 18 70 00 • Fax. +34 943 - 18 70 20
www.jaso.com

Fecha / Date: 11/10/2022

FEM 1001

DELEGACION / DEALER

Reservado el derecho a modificaciones sin previo aviso. Declinamos toda responsabilidad derivada de la información proporcionada / Subject to modification, without prior notice.
This information is supplied without liability / L'entreprise se réserve le droit de procéder à des modifications sans préavis. Nous déclinons toute responsabilité quant aux informations
fournies / Das Recht auf Änderungen ohne vorherige Ankündigung bleibt vorbehalten. Wir übernehmen keine Gewähr für die gemachten Angaben / Мы оставляем за собой право
на внесение изменений без предварительного уведомления. Мы снимаем с себя любую ответственность в отношении предоставленной информации

حقوق التغيير محفوظة دون إشعار مسبق. دون أدنى مسؤولية عن المعلومات المقدمة