

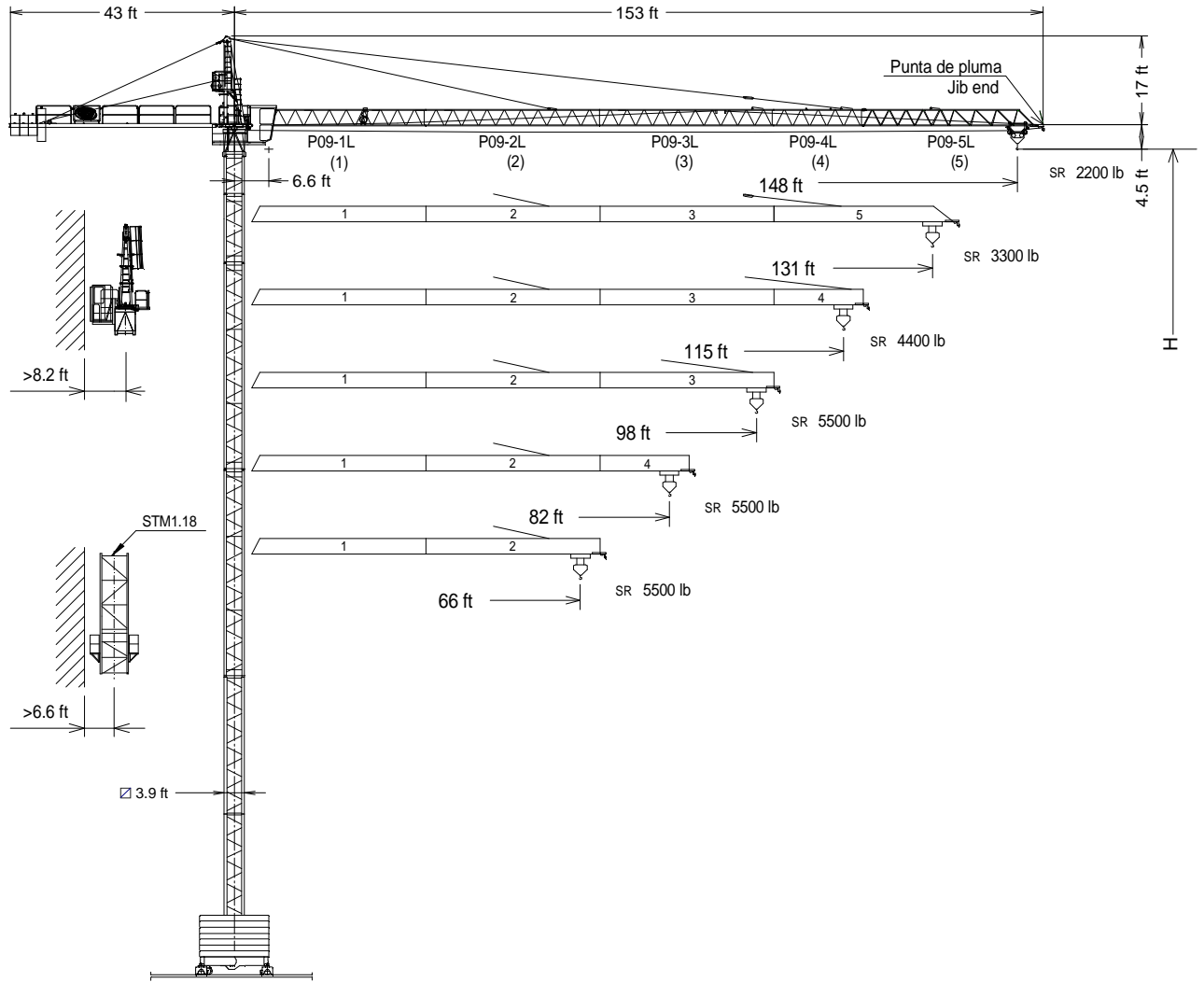

UNE 58-101
FEM 1001

UNE-EN-ISO 9001



H_{SR} = Altura máxima bajo gancho sin arriostrar (m).
Maximum height under hook without fastening (m).



H_{SR} - 6.6 ft

(H) TRASLACIÓN / TRAVELLING

(H) ESTACIONARIA / STATIONARY

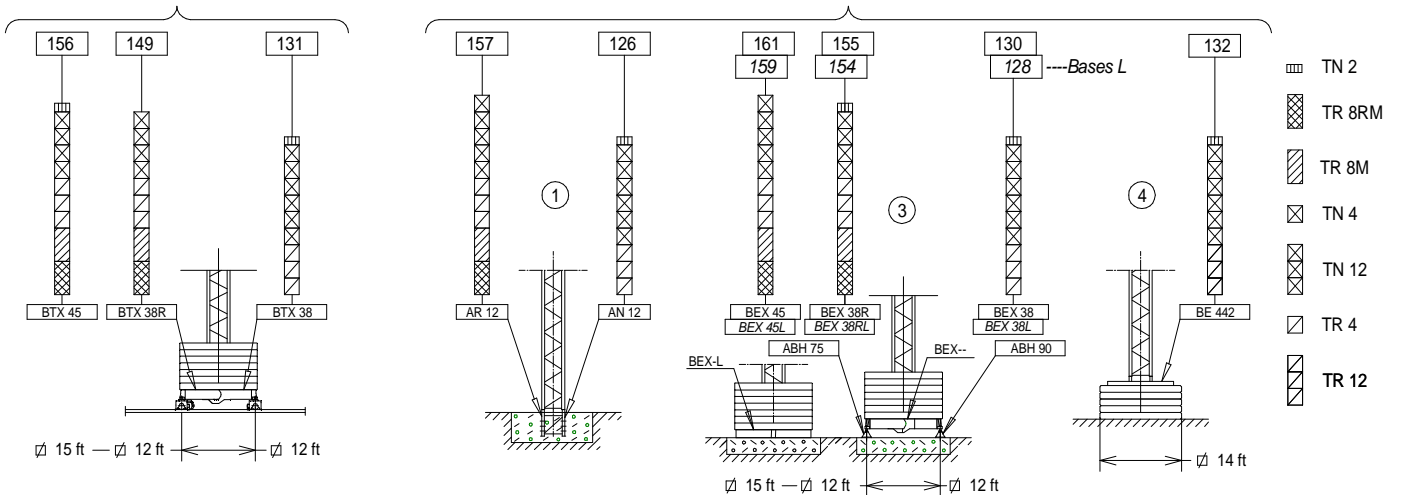





Fecha / Date: 18/11/2022









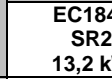
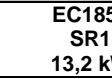

FEM 1001

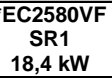



Reservado el derecho a modificaciones sin previo aviso. Declinamos toda responsabilidad derivada de la información proporcionada / Subject to modification, without prior notice. This information is supplied without liability

CARGAS / LOADS								J4510
	SR1 (lb)	Cargas máximas / Maximum loads SR1 - 4400 lb						
	4400 lb @...[ft]	Alcance del gancho [ft] / Hook reach [ft]						
		66	82	98	115	131	148	
148	82	4400	4400	3600	3000	2550	2200	
131	102	4400	4400	4400	3900	3300	---	
115	115	4400	4400	4400	4400	---	---	
98	98	4400	4400	4400	---	---	---	
82	82	4400	4400	---	---	---	---	
66	66	4400	---	---	---	---	---	

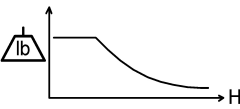
CARGAS / LOADS								J4510
	SR2 (lb)	Cargas máximas / Maximum loads SR2 - 5500 lb						
	5500 lb @...[ft]	Alcance del gancho [ft] / Hook reach [ft]						
		66	82	98	115	131	148	
148	67	5500	4400	3600	3000	2500	2200	
131	84	5500	5500	4600	3900	3300	---	
115	94	5500	5500	5200	4400	---	---	
98	98	5500	5500	5500	---	---	---	
82	82	5500	5500	---	---	---	---	
66	66	5500	---	---	---	---	---	

CARACTERÍSTICAS DE MECANISMOS / MECHANISMS FEATURES								J4510
*opcional *optional								
	2870 5510 5510	2425 4410 4410	2870 5510	2425 4410	0...82 ft/min	0... 0,8 r/min sl/min	98/196 ft/min *0...98 *98...196 ft/min	3.3 ft/min
	H ≤ SR 633 ft		SR 620 ft		 480V 60Hz	EC1846 EC1856		AMPERAGE = 40 A
	1788 ft		1946 ft			EC2566 VF EC2580 VF		AMPERAGE = 45 A
								

LASTRES INFERIORES / LOWER BALLASTS							J4510
	H (ft)	59	72	98	131	151	161
BEX 45 / BTX 45	 9050 lb	6		8	10	12	14
BEX45L		8			10	12	14
BEX 38R / BTX 38R		6	8	10	12	16	---
BEX 38 / BTX 38		6	8	10	12	---	---
BEX 38RL		8		10	12	16	---
BEX 38L		8		10	12	---	---
	H (ft)	105			132		
BE 442	 7600 lb	16			20		

H: Altura bajo gancho / Height under hook

Para alturas intermedias tomar el lastre correspondiente a la altura superior / For intermediate heights take the ballast corresponding to the higher height

Fecha / Date: 18/11/2022

 FEM 1001



Reservado el derecho a modificaciones sin previo aviso. Declinamos toda responsabilidad derivada de la información proporcionada / Subject to modification, without prior notice. This information is supplied without liability

DENOMINACIÓN / DENOMINATION		L [ft]	A [ft]	H [ft]	P / W [lb]		
Torre Tower	TR 8RM – TR 8M	26.5	3.9	3.9	5675-5545		
	TR 12 – TN 12	39.4	3.9	3.9	6260-6130		
	TR 4	13.0	3.9	3.9	2360		
	TN 4	13.4	3.9	3.9	2325		
	TN 2	7.5	3.9	3.9	1730		
Conjunto asiento pista, punta de torre, orientación y elevación <i>Slewing table assembly, tower head, slewing and hoisting mechanism</i>			22.9	5.4	7.9	7985	
Tramo de pluma Jib section	P09 1L (1)	33.2	3.3	3.8	1435		
	P09 2L (2)	33.2	2.8	3.6	1210		
	P09 3L (3)	33.3	2.8	3.6	1245		
	P09 4L (4)	17.3	2.8	3.6	550		
	P09 6L (5)	33.2	2.8	3.6	900		
Polipasto <i>Hook assembly</i>	SR		2.5	0.5	3.1	300	
Carro / Trolley	SR		3.3	4.4	2.4	245	
Contrapluma con plataformas <i>Counterjib with platforms</i>			39.2	4.4	1.3	2080	
Plataforma y cabina <i>Platform and cabin</i>			12.1	5.3	7.4	1810	
Contrapeso <i>Counterweight</i>	Grande / Big		3.5	1.6	6.6	5205	
	Pequeño / Small		3.5	1.6	4.3	3310	
Base grúa Testero largo <i>Crane base Long carriage</i>	BTX 38		20.0	2.1	5.0	3475	
	BTX 38R		20.0	2.1	5.2	3950	
	BTX 45		23.0	2.1	5.2	4555	
	BTX 38L		17.9	1.8	3.2	2560	
			BTX 38RL	17.9	1.8	2.9	1875
			BTX 45L	13.2	1.8	2.9	1455
	BEX 38		18.2	1.0	4.2	3065	
			BEX 38R	18.2	1.0	4.6	3505
			BEX 45	21.5	1.0	4.6	4110
Mecanismo traslación grúa <i>Crane travelling mechanism</i>			3.1	1.8	2.2	650	
Lastre <i>Ballast</i>	☑ 9 ft		9.8	1.4	4.3	8160	
	☑ 12 ft - ☑ 15 ft		13.1	1.1	4.3	9040	
	BE 442		6.9	1.1	6.9	7610	
			BE 434	11.2	1.1	5.5	9480
	Torre de montaje <i>Jacking cage</i>		TMU 1.18	23.4	5.8	5.6	7055
Torre de montaje sin puerta, carro, plataforma carro y viga de apoyo <i>Jacking cage without door, trolley, trolley platform and beam assembly</i>			23.4	5.8	5.6	5400	



T	H									H	T	
1	15	TN 4	146.32.000	TN 4	15	1	TN 2	9	1	TN 4	15	1
2	28	TN 4		TN 4	28	2	TN 4	22	2	TN 4	28	2
3	67	TN 12	146.31.000	TN 12	67	3	TN 12	61	3	TN 12	67	3
4	106	TR 12	146.30.000	TR 12	106	4	TR 12	100	4	TR 12	106	4
5	132	TR 8M	146.30.800	TR 8M	132	5	TR 8M	126	5	TR 8M	132	5
6	144	TX-90/TXXR	202.36.500	TX-90/TXXR	144	6	TX-90/TXXR	138	6	TX-90/TXXR	144	6
7	154	T 3-90	133.32.000	T 3-90	154	7	T 3-90	148	7	T 3-90	154	7
8	163				163	8		157	8		163	8
9	173				173	9		176	9		173	9
		AN 90		AN 90								
		AN 150		AN 150								
		AL 20		AL 20								
		ALD 20		ALD 20								
		AS 20		AS 20								
		ASD 20/24		ASD 20/24								
		ASR 20		ASR 20								
		ASRD 20/24		ASRD 20/24								

AN 90 133.21.000
 AND 90 133.21.800
 AN 150 161.21.000
 AND 150 161.21.050
 AL 20 153.21.800
 ALD 20 160.21.250
 AS 20 160.21.010
 ASD 20/24 160.21.080
 ASR 20 160.21.200
 ASRD 20/24 156.21.000

T: Torre / Tower
 H: Altura / Height

Transporte / Transport

H = 126 + AN12

2x

3x **HIGH CUBE 40'**

≤ 6xTN4

TREPADO / CLIMBING J4510

$h_{max} = 3 \times TR4 + 6 \times TN4$

h (ft)	118
D (ft)	20 - 33
P (lbf)	71700 66100
Rmax (lbf)	29000 54850

TR4: 800.32.300

Trepado interno / Internal climbing

- Viento fuera de servicio / Out of service wind
- Consultar / Consult
- En servicio / In service
- Fuera de servicio / Out of service



Ctra./Rd. Madrid - Irún Km. 415 - 20.213 IDIAZABAL [Gipuzkoa] ESPAÑA / SPAIN
 P.O. Box, 23 - 20.200 BEASAIN - E-mail: jaso@jaso.com
 Tel. +34 943 - 18 70 00 • Fax. +34 943 - 18 70 20
www.jaso.com

Fecha / Date: 18/11/2022

Reservado el derecho a modificaciones sin previo aviso. Declinamos toda responsabilidad derivada de la información proporcionada / Subject to modification, without prior notice.
 This information is supplied without liability

FEM 1001

DELEGACION / DEALER