



# J390

UNE 58-101  
FEM 1001

**GRUA TORRE / TOWER CRANE**  
GRUE A TOUR / TURMDREHKRAN / БАШЕННЫЙ КРАН / رافعة برجية

FEM 1001

UNE-EN-ISO 9001

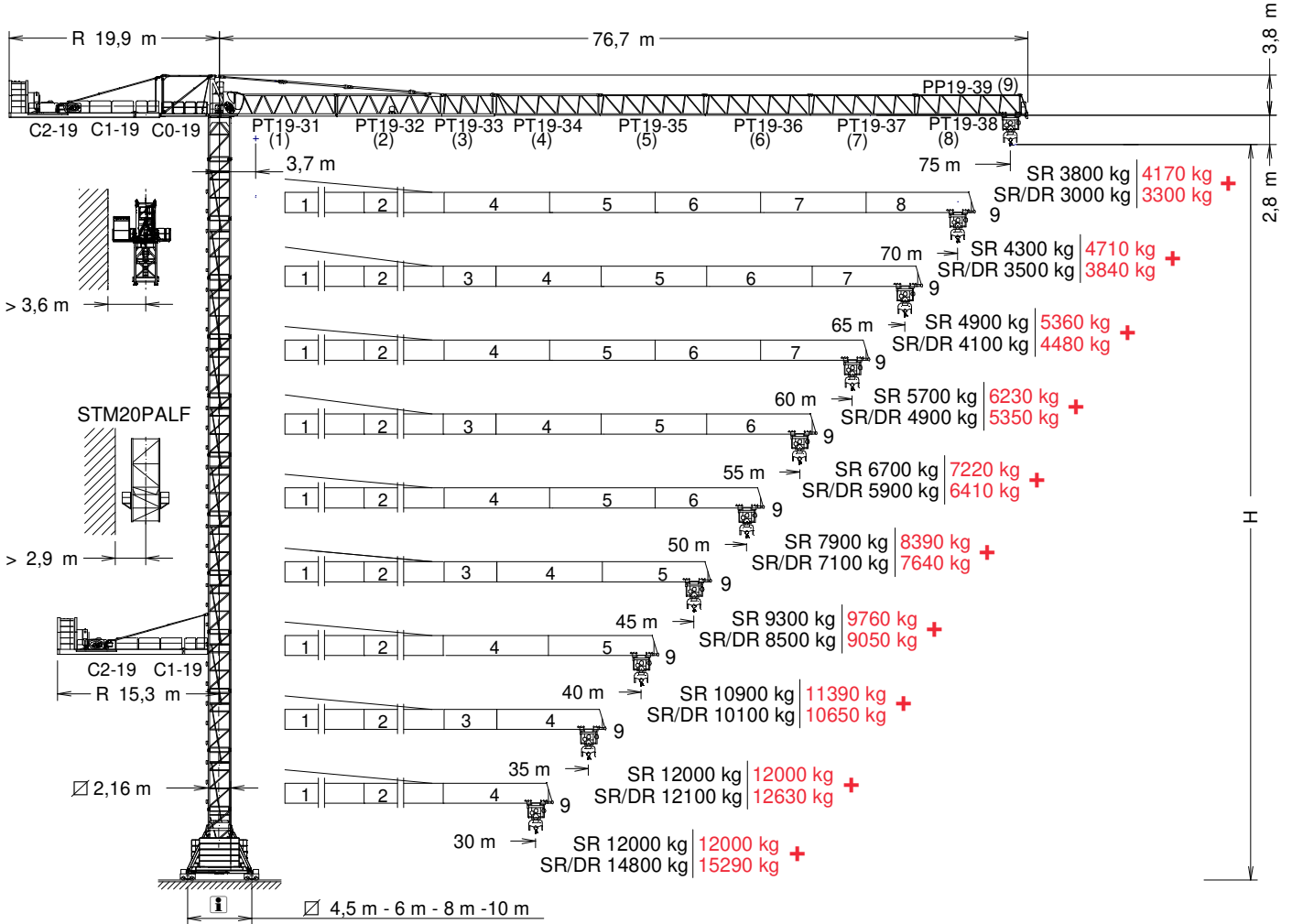

\*OPTIONAL EXTRA LIFT

H= **Altura máxima bajo gancho sin arriostrar (m).** / **Maximum height under hook without fastening (m).** / **Hauteur maximale sous crochet sans ancrage (m).**  
Max. Hakenhöhe ohne Verstreben (m). / Максимальная высота под крюком без крепления (m). / أقصى ارتفاع تحت الخطاف بدون ربط

PT19-31.....166.40.600	PT19-35.....166.44.600	PP19-39.....166.47.900	TS20-5,6.....204.31.200
PT19-32.....166.41.600	PT19-36.....166.45.600	TL20-5,6.....204.31.400	TSR20-5,6A.....206.31.300
PT19-33.....166.42.600	PT19-37.....166.46.200	TS20-5,6A.....204.31.500	TSR20-5,6.....206.31.000
PT19-34.....166.43.600	PT19-38.....166.47.300		

## CUSTOMIZE YOUR CRANE

**OPTIMUS**  
line

EXTRA Lift	OPTI Cube	TC Diagnosis SYSTEM	CLIMBING Solution	SAFETY Pack	Customization	ECO Mode	COMFORT Cabin	HIGH-POWER Motors	JL25 Tower Crane Elevator	BE SMART keep control



Reservado el derecho a modificaciones sin previo aviso. Declinamos toda responsabilidad derivada de la información proporcionada / Subject to modification, without prior notice. This information is supplied without liability / L'entreprise se réserve le droit de procéder à des modifications sans préavis. Nous déclinons toute responsabilité quant aux informations fournies / Das Recht auf Änderungen ohne vorherige Ankündigung bleibt vorbehalten. Wir übernehmen keine Gewähr für die gemachten Angaben / Мы оставляем за собой право на внесение изменений без предварительного уведомления. Мы снимаем с себя любую ответственность в отношении предоставленной информации / حقوق التغيير محفوظة دون إشعار مسبق. بدون أدنى مسؤولية عن المعلومات المقدمة

29/11/2024

(H) ESTACIONARIA 1 / STATIONARY 1 / STATIONAIRE 1 / STATIONÄR 1 / СТАЦИОНАРНОЕ СОСТОЯНИЕ / ثابتة

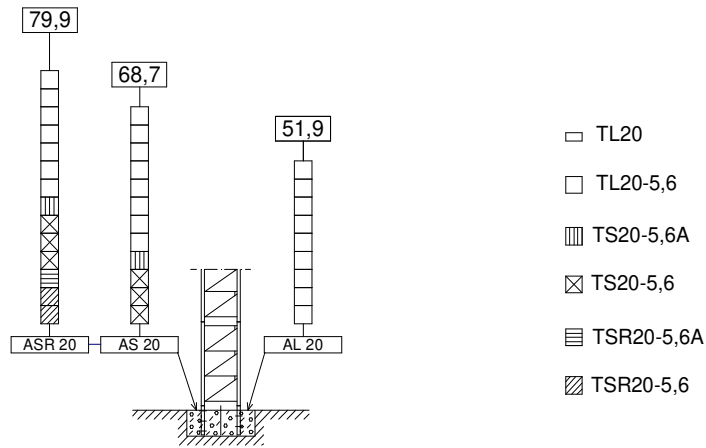

(H) ESTACIONARIA 3 / STATIONARY 3 / STATIONAIRE 3 / STATIONÄR 3 / СТАЦИОНАРНОЕ СОСТОЯНИЕ / ثابتة

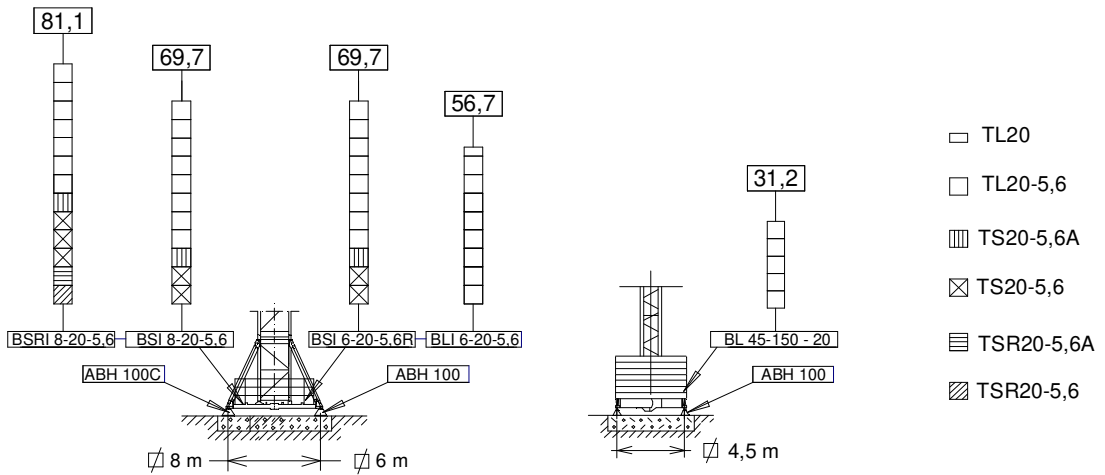

(H) TRASLACION / TRAVELLING / TRASLATION / FORTBEWEGUNG / ПЕРЕМЕЩЕНИЕ / متحركة

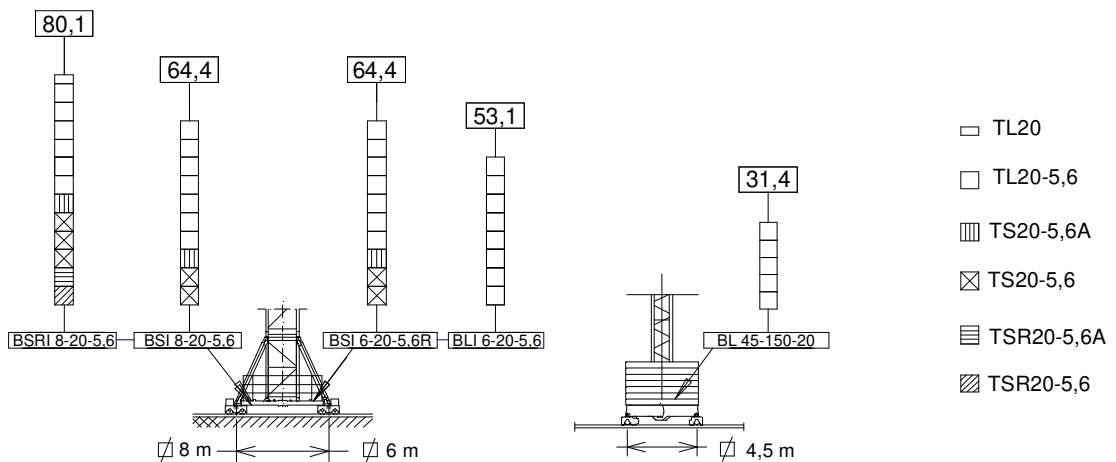

AL20 .....	153.21.800
AS20 .....	160.21.010
ASR20 .....	160.21.200

BL45-150-20 .....	171.20.200
BLI 6-20-5,6 .....	211.20.500
BSI 6-20-5,6R .....	211.20.400

BSI 8-20-5,6 .....	211.20.000
BSRI 8-20-5,6 .....	204.20.000

ABH 100 .....	201.23.000
ABH 100C .....	170.23.000

SR - 12 t																
SR	12 t @ ... (m)	15	20	25	30	35	40	45	50	55	60	65	70	75	EXTRA Lift	
75	27,7	12,0	12,0	12,0	11,01	9,29	8,00	7,00	6,20	5,54	5,00	4,54	4,14	3,80	+	
	28,9	12,0	12,0	12,0	11,55	9,79	8,47	7,45	6,63	5,96	5,40	4,93	4,52	4,17		
70	28,6	12,0	12,0	12,0	11,37	9,60	8,28	7,24	6,42	5,74	5,18	4,70	4,30	—	+	
	29,8	12,0	12,0	12,0	11,92	10,12	8,77	7,72	6,87	6,19	5,61	5,13	4,71	—		
65	29,5	12,0	12,0	12,0	11,79	9,96	8,59	7,52	6,67	5,97	5,39	4,90	—	—	+	
	30,8	12,0	12,0	12,0	12,0	10,49	9,1	8,02	7,16	6,45	5,86	5,36	—	—		
60	30,9	12,0	12,0	12,0	12,0	10,49	9,05	7,93	7,04	6,31	5,70	—	—	—	+	
	32,3	12,0	12,0	12,0	12,0	11,04	9,6	8,47	7,58	6,84	6,23	—	—	—		
55	32,6	12,0	12,0	12,0	12,0	11,10	9,59	8,41	7,47	6,70	—	—	—	—	+	
	34,0	12,0	12,0	12,0	12,0	11,65	10,13	8,94	8,0	7,22	—	—	—	—		
50	34,2	12,0	12,0	12,0	12,0	11,71	10,12	8,89	7,90	—	—	—	—	—	+	
	35,8	12,0	12,0	12,0	12,0	12,0	10,66	9,40	8,39	—	—	—	—	—		
45	35,7	12,0	12,0	12,0	12,0	12,0	10,58	9,30	—	—	—	—	—	—	+	
	37,2	12,0	12,0	12,0	12,0	12,0	11,11	9,76	—	—	—	—	—	—		
40	36,6	12,0	12,0	12,0	12,0	12,0	10,90	—	—	—	—	—	—	—	+	
	38,2	12,0	12,0	12,0	12,0	12,0	11,39	—	—	—	—	—	—	—		
35	35,0	12,0	12,0	12,0	12,0	12,0	—	—	—	—	—	—	—	—	+	
	35,0	12,0	12,0	12,0	12,0	12,0	—	—	—	—	—	—	—	—		
30	30,0	12,0	12,0	12,0	12,0	—	—	—	—	—	—	—	—	—	+	
	30,0	12,0	12,0	12,0	12,0	—	—	—	—	—	—	—	—	—		

SR/DR 12 / 24 t																
SR/DR	12 - 24 t @ ... (m)	15	20	25	30	35	40	45	50	55	60	65	70	75	EXTRA Lift	
75	26,2/14,0	12,0/22,27	12,0/16,25	12,0/12,63	10,22	8,50	7,21	6,21	5,41	4,75	4,20	3,74	3,34	3,0	+	
	26,9/14,3	12,0/22,79	12,0/16,70	12,0/13,05	10,61	8,87	7,56	6,55	5,74	5,07	4,52	4,05	3,65	3,30		
70	26,9/14,4	12,0/23,0	12,0/16,79	12,0/13,07	10,59	8,81	7,48	6,45	5,62	4,95	4,38	3,90	3,50	—	+	
	27,8/14,7	12,0/23,53	12,0/17,26	12,0/13,50	11,0	9,21	7,87	6,82	5,99	5,30	4,73	4,25	3,84	—		
65	27,8/14,9	12,0/23,83	12,0/17,41	12,0/13,57	11,0	9,17	7,79	6,73	5,87	5,17	4,59	4,10	—	—	+	
	28,7/15,2	12,0/24,0	12,0/17,90	12,0/14,02	11,44	9,59	8,21	7,13	6,27	5,56	4,98	4,48	—	—		
60	29,2/15,6	12,0/24,0	12,0/18,33	12,0/14,30	11,61	9,69	8,26	7,14	6,24	5,51	4,90	—	—	—	+	
	30,2/15,9	12,0/24,0	12,0/18,84	12,0/14,80	12,0/12,10	10,17	8,72	7,60	6,70	5,96	5,35	—	—	—		
55	30,7/16,4	12,0/24,0	12,0/19,40	12,0/15,16	12,0/12,33	10,31	8,79	7,61	6,67	5,90	—	—	—	—	+	
	31,9/16,8	12,0/24,0	12,0/19,93	12,0/15,68	12,0/12,85	10,82	9,31	8,13	7,18	6,41	—	—	—	—		
50	32,3/17,3	12,0/24,0	12,0/20,47	12,0/16,01	12,0/13,04	10,92	9,33	8,09	7,10	—	—	—	—	—	+	
	33,6/17,6	12,0/24,0	12,0/21,01	12,0/16,55	12,0/13,58	11,46	9,87	8,63	7,64	—	—	—	—	—		
45	33,6/18,0	12,0/24,0	12,0/21,39	12,0/16,75	12,0/13,66	11,44	9,79	8,50	—	—	—	—	—	—	+	
	35,0/18,4	12,0/24,0	12,0/21,93	12,0/17,29	12,0/14,20	11,99	10,34	9,05	—	—	—	—	—	—		
40	34,5/18,5	12,0/24,0	12,0/22,01	12,0/17,25	12,0/14,07	11,80	10,10	—	—	—	—	—	—	—	+	
	35,9/18,8	12,0/24,0	12,0/22,55	12,0/17,79	12,0/14,62	12,0/12,35	10,65	—	—	—	—	—	—	—		
35	35,0/18,9	12,0/24,0	12,0/22,53	12,0/17,66	12,0/14,42	12,0/12,10	—	—	—	—	—	—	—	—	+	
	35,0/19,3	12,0/24,0	12,0/23,06	12,0/18,19	12,0/14,95	12,0/12,63	—	—	—	—	—	—	—	—		
30	30,0/19,3	12,0/24,0	12,0/23,11	12,0/18,12	12,0/14,80	—	—	—	—	—	—	—	—	—	+	
	30,0/19,7	12,0/24,0	12,0/23,63	12,0/18,63	12,0/15,29	—	—	—	—	—	—	—	—	—		

Datos válidos para / Valid data for  
Donnees valables pour / Gultige Daten für / Допустимые данные для / البيانات الصالحة ل



H ≤ 70 m



FEM 1001



Reservado el derecho a modificaciones sin previo aviso. Declinamos toda responsabilidad derivada de la información proporcionada / Subject to modification, without prior notice. This information is supplied without liability / L'entreprise se réserve le droit de procéder à des modifications sans préavis. Nous déclinons toute responsabilité quant aux informations fournies / Das Recht auf Änderungen ohne vorherige Ankündigung bleibt vorbehalten. Wir übernehmen keine Gewähr für die gemachten Angaben / Мы оставляем за собой право на внесение изменений без предварительного уведомления. Мы снимаем с себя любую ответственность в отношении предоставленной информации / حقوق التغيير محفوظة دون إشعار مسبق. بدون أدنى مسؤولية عن المعلومات المقدمة /

**\*EC6080VF**  
45 kW



**EC88115VF**  
65 kW

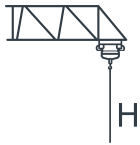
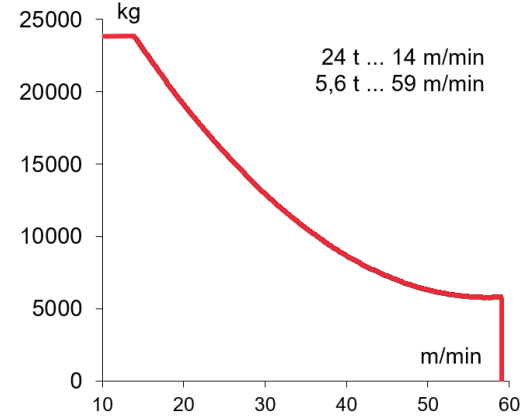
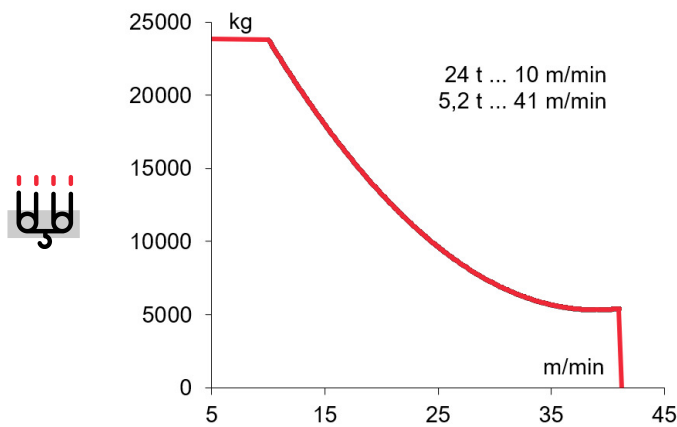
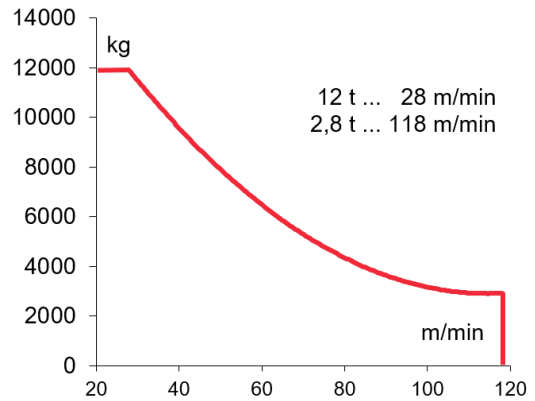
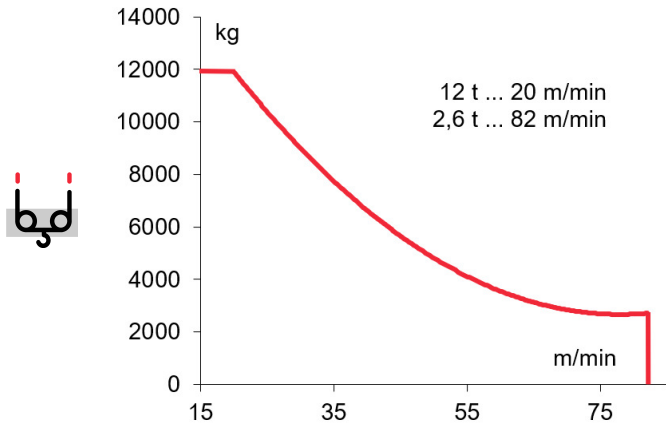

$H \leq$  SR 310 m  
DR 155 m

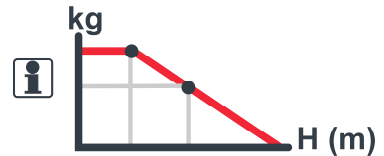

 <b>OG2208VF</b> 3 x 5,5 kW	 <b>TC1595VF</b> 11 kW	 <b>TG4025VF</b> 4 x 7,5 kW	 <b>TH2006</b> 15 kW
0...0,8 r/min sl/min	12 t 0...94 m/min 24 t 0...47 m/min	0...25 m/min	0,6 m/min

3~ 400V 50Hz  
480V 60Hz

KVA			
<b>EC6080VF</b>	58	71	84
<b>EC88115VF</b>	64	79	95



**FEM 1001**

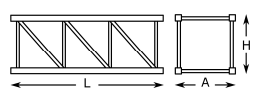
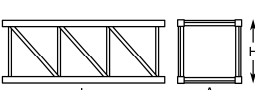
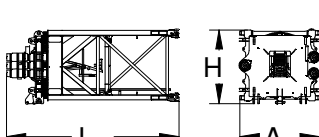
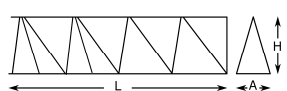
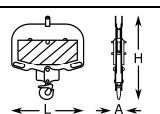
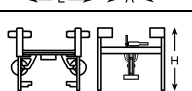
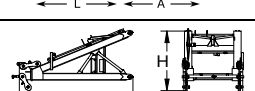
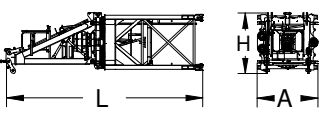
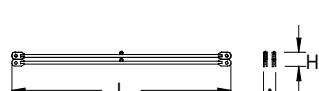

			L (m)	A (m)	H (m)	P/W (kg)		
<b>Torre inferior / Lower tower</b> Tour inférieure / Unterer Turm Нижняя башня / البرج السفلي	TLI20-5,6		5,886	2,306	2,357	4235		
	TSI20-5,6		5,966	2,328	2,390	5390		
	TSRI20-5,6		5,990	2,257	2,257	6562		
	TRID24-5,6		5,990	3,202	3,202	8400		
<b>Torre / Tower</b> Tour / Turm / Башня / برج	TL20		4,175	2,201	2,281	2095		
	TL20-5,6		5,886	2,306	2,357	2910		
	TS20-5,6A		5,978	2,381	2,331	3530		
	TS20-5,6		5,966	2,328	2,390	3550		
	TSR20-5,6A		5,926	2,388	2,325	4170		
	TSR20-5,6		5,990	2,257	2,257	4210		
	TR24-5,6		5,990	2,760	2,835	4760		
TRD24-5,6	5,977	2,740	2,285	5280				
<b>Torre asiento pista + punta de torre + orientación</b> <b>Slewing table + tower head + slewing mechanism</b> Tour pivot + porte-flèche + mécanisme d'orientation Turmsitz + Turmspitze + Ausrichtung Сиденье площадки + верхней секции башни + поворотный механизм برج وحدة الدوارن + رأس البرج + آلية الدوران			5,319	2,51	2,52	7650		
	PT19-31		10,160	1,600	2,200	3090		
	PT19-32+Tr		10,225	1,600	2,270	3655		
	PT19-33		5,290	1,600	2,180	1670		
	PT19-34		10,270	1,600	2,180	2860		
<b>Tramo de pluma</b> <b>Jib section</b> Tronçon de flèche Auslegerabschnitt Секция стрелы أجزاء الذراع	PT19-35		10,250	1,600	2,050	2230		
	PT19-36		10,230	1,600	2,040	1620		
	PT19-37		10,210	1,600	2,040	1125		
	PT19-28		10,190	1,740	2,040	965		
	PP19-39		1,025	1,740	0,775	205		
	<b>Polipasto / Hook assembly</b> Palan / Flaschenzug Полиспаст / بكرة		SR - 12 t		1,350	0,300	1,300	400
			SR / DR - 24 t		1,490	0,400	1,680	705
<b>Carro / Trolley</b> Chariot / Laufkatze Грузовая тележка / عرب	SR - 12 t		2,320	2,420	1,610	620		
	SR / DR - 24 t		2,660	2,350	2,135	1115		
<b>Punta de torre / Tower head / Porte-flèche</b> Turmspitze / верхняя секция башни / رأس البرج			3,662	1,97	1,99	2280		
<b>Conjunto asiento pista, punta de torre, orientación</b> <b>Slewing table assembl +, tower head + slewing</b> Groupe pivot + porte-flèche + mécanisme d'orientation Gruppe Turmsitz + Turmspitze + Ausrichtung Сиденье площадки + верхняя секция башни + поворотный механизм مجموعة وحدة الدوارن + رأس البرج + آلية الدوران			8,120	2,51	2,52	9930		
<b>Tirante sostén pluma / Jib support tie</b> Tirant de fleche / Haltestange Ausleger Растяжка поддержки / مشد دعامة الذراع			6,540	1,785	0,335	3175		



		L (m)	A (m)	H (m)	P/W (kg)		
<b>Contrapluma / Counterjib</b> Contre-flèche Gegenausleger Противовесная консоль / الذراع المعاكس	C0-19		4,760	1,960	0,510	2555	
	C1-19		2,532	1,906	0,585	960	
<b>Contrapluma con mecanismos (sin cable) + plumín auxiliar + armario eléctrico / Counterjib with mechanism (without rope) + auxiliary jib + electrical cabinet</b> Contre-flèche avec mécanisme (sans cale) + fléchette auxiliaire + armoire électrique / Gegenausleger + Mechanismus (ohne Seil) + Ausleger + stromkasten / Противовесная консоль с механизмами (без троса) и вспомогательной дополнительной стрелой + Электрошкаф مع آليات (بدون كابل) وريشة مساعدة الذراع المعاكس	C2-12		12,00	2,100	2,355	8600	
<b>Plataforma y cabina / Platform and cabin</b> Plateforme et cabine / Plattform + Führerstand Платформа и кабина / منصة وكابينة			3,520	2,060	2,400	1.085	
<b>Armario eléctrico y plataforma</b> Electrical cabinet and platform / Armoire électrique et plateforme / Stromkasten + Plattform / الخزانة الكهربائية والمنصة			2,755	1,601	2,462	1010	
<b>Transporte torre de montaje</b> Jacking cage transport Transport de tour de Montag Transport Montageturm Транспортировка монтажной башни نقل برج التركيب		TM20PALF-5,6 	9,955	1,851	2,525	6615	
<b>Contrapeso / Counterweight</b> Contrepoids / Gegengewicht Противовес / اوزان معاكسة		<b>Lastre / Ballast / Lest</b> Ballast / Балласт / ثقل		3,800	0,580	1,500	6000
				3,800	0,275	1,500	3000
				3,800	0,180	1,500	2000

**TREPADO / CLIMBING / TÉLESCOPAGE / KLETTERSYSTEM / ЛЕСТНИЦА / التسلق**

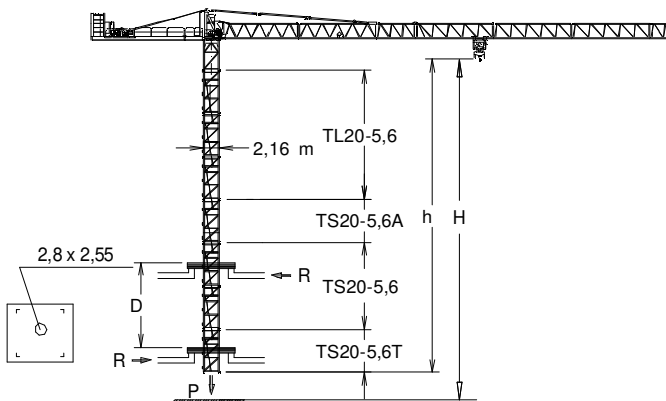

h <sub>max</sub> :		
TS20-5,6T + 2xTS20-5,6 + TS20-5,6A + 4xTL20-5,6		
30 m		
h (m)	46,3	
D (m)	17,2 – 21,7	
P (KN)	1210	970
R <sub>max</sub> (KN)	208	390

TS20-5,6T: 160.32.600

**Trepado interno / Internal climbing / Téléscopage / Inneres klettersystem / Внутренняя лестница / التسلق الداخلي**



Reservado el derecho a modificaciones sin previo aviso. Declinamos toda responsabilidad derivada de la información proporcionada / Subject to modification, without prior notice. This information is supplied without liability / L'entreprise se réserve le droit de procéder à des modifications sans préavis. Nous déclinons toute responsabilité quant aux informations fournies / Das Recht auf Änderungen ohne vorherige Ankündigung bleibt vorbehalten. Wir übernehmen keine Gewähr für die gemachten Angaben / Мы оставляем за собой право на внесение изменений без предварительного уведомления. Мы снимаем с себя любую ответственность в отношении предоставленной информации / حقوق التغيير محفوظة دون إشعار مسبق. بدون أدنى مسؤولية عن المعلومات المقدمة

# COMPOSICIONES DE TORRE / TOWER COMPOSITIONS

COMPOSITIONS DE LA TOUR / TURMZUSAMMENSETZUNGEN / КОНСТРУКЦИЯ БАШНИ / مكونات البرج

J390

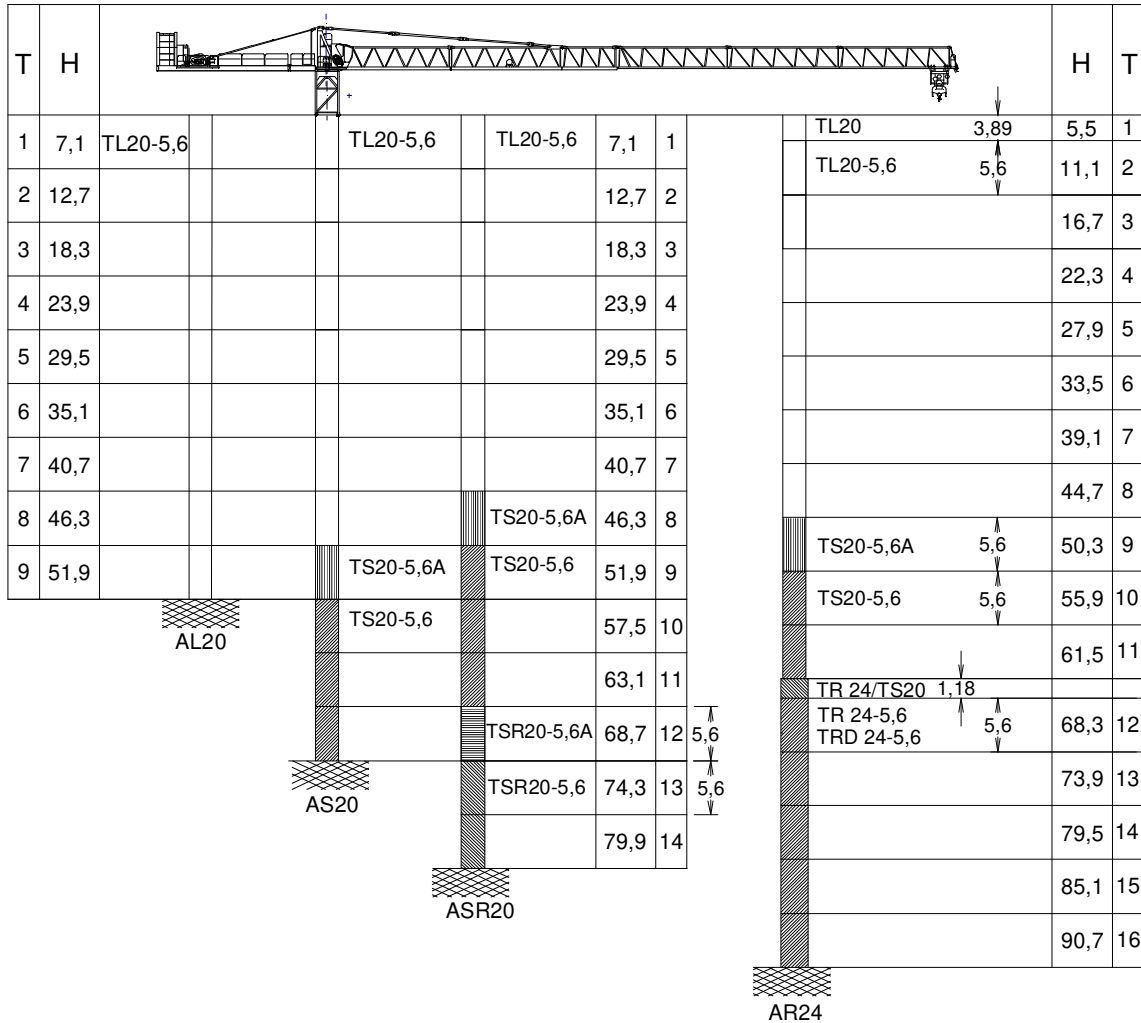

T : Torre / Tower / Tour / Turm / Башни / أبراج  
H : Altura / Height / Hauteur / Höhe / Высота / ارتفاع

TL20	153.31.000	TSR20-5,6A	206.31.300	TRD24-5,6	206.32.300	ASD 20/24	160.21.080
TL20-5,6	204.31.400	TSR20-5,6	206.31.000	AL 20	153.21.800	ASR 20	160.21.200
TS20-5,6A	204.31.500	TR24/TS20	156.36.400	ALD 20	160.21.250	ASRD 20/24	156.21.000
TS20-5,6	204.31.200	TR24-5,6	206.32.000	AS 20	160.21.010	AR24	156.21.200

**Otras configuraciones de torre / Other tower configuration / Autres configurations / Andere turmkonfigurationen / Прочие конфигурации / مكونات أخرى**

## TRANSPORTE / TRANSPORT / TRANSPORT / TRANSPORT / ТРАНСПОРТИРОВКА / نقل

J390



H = 9 x TL20-5,6 + AL20 +

10 x



11 x



**Viento fuera de servicio / Out of service wind / Vitesse du vent hors service / Wind außer betrieb / Ветровая нагрузка в покое / الريح خارج الخدمة**

**Consultar / Consult / Nous consulter / Anfragen / Консультируйтесь / الرجوع إلى**

**En servicio / In service / En service / In betrieb / В работе / في الخدمة**

**Fuera de servicio / Out of service / Hors service / Außer betrieb / В покое / خارج الخدمة**

**Opcional / Optional / En option / Optional / Опция / اختياري**



Ctra./ Rd. Madrid – Irún - Km. 415 - 20213 IDIAZABAL (Gipuzkoa) - ESPAÑA / SPAIN

P.O. Box, 23 - 20.200 - BEASAIN - E-mail: jaso@jaso.com

Tel. +34 943 - 18 70 00 • Fax. +34 943 - 18 70 20

www.jaso.com

29/11/2024



FEM 1001

DELEGACIÓN / DEALER

Reservado el derecho a modificaciones sin previo aviso. Declinamos toda responsabilidad derivada de la información proporcionada / Subject to modification, without prior notice. This information is supplied without liability / L'entreprise se réserve le droit de procéder à des modifications sans préavis. Nous déclinons toute responsabilité quant aux informations fournies / Das Recht auf Änderungen ohne vorherige Ankündigung bleibt vorbehalten. Wir übernehmen keine Gewähr für die gemachten Angaben / Мы оставляем за собой право на внесение изменений без предварительного уведомления. Мы снимаем с себя любую ответственность в отношении предоставленной информации / حقوق التغيير محفوظة دون إشعار مسبق. دون أدنى مسؤولية عن المعلومات المقدمة