



EN 14439
C25

J390

GRUA TORRE / TOWER CRANE

FEM 1005 - C25

UNE-EN-ISO 9001

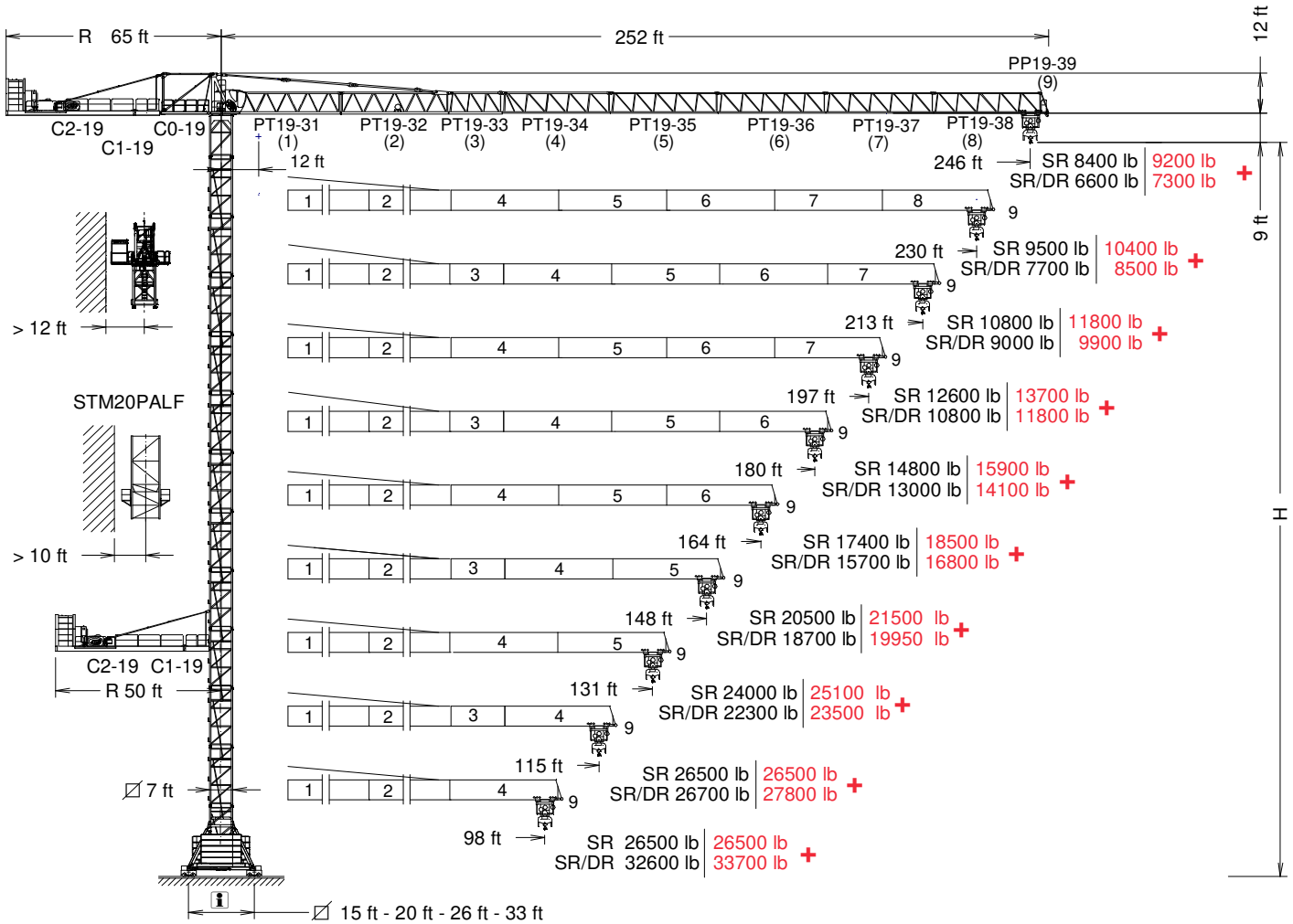

*OPTIONAL EXTRA LIFT

H= Altura máxima bajo gancho sin arriostrar (ft). / Maximum height under hook without fastening (ft).

PT19-31	166.40.600
PT19-32	166.41.600
PT19-33	166.42.600
PT19-34	166.43.600

PT19-35	166.44.600
PT19-36	166.45.600
PT19-37	166.46.200
PT19-38	166.47.300

PP19-39	166.47.900
TL20-5,6	204.31.400
TS20-5,6A	204.31.500

TS20-5,6	204.31.200
TSR20-5,6A	206.31.300
TSR20-5,6	206.31.000

CUSTOMIZE YOUR CRANE

OPTIMUS
line JASD

EXTRA Lift	OPTI Cube	TC Diagnosis SYSTEM	CLIMBING Solution	SAFETY Pack	Customization	ECO Mode	COMFORT Cabin	HIGH-POWER Motors	J25 Tower Crane Elevator	BE SMART keep control



Reservado el derecho a modificaciones sin previo aviso. Declinamos toda responsabilidad derivada de la información proporcionada / Subject to modification, without prior notice. This information is supplied without liability

(H) ESTACIONARIA 1 / STATIONARY 1

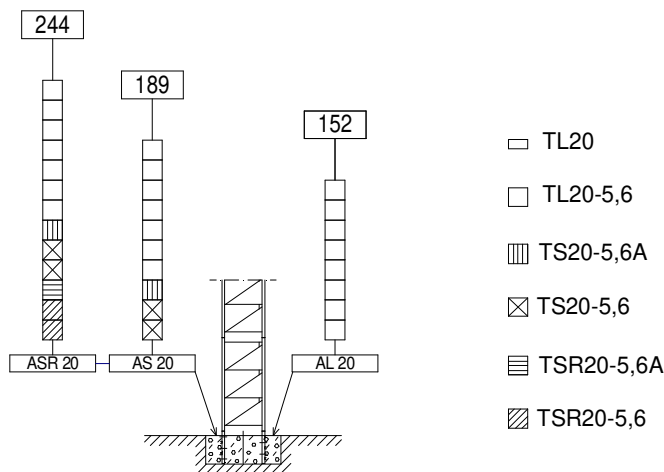

(H) ESTACIONARIA 3 / STATIONARY 3

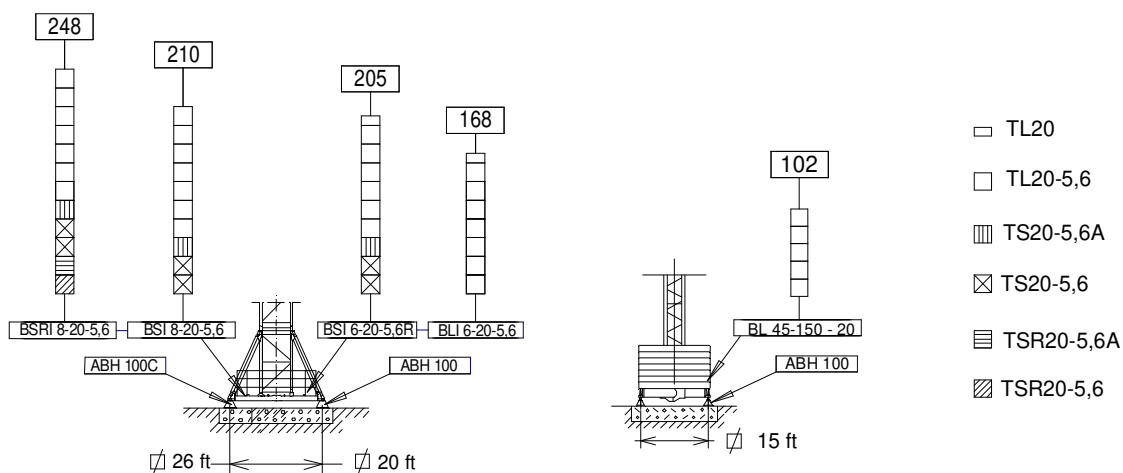

(H) TRASLACIÓN / TRAVELLING

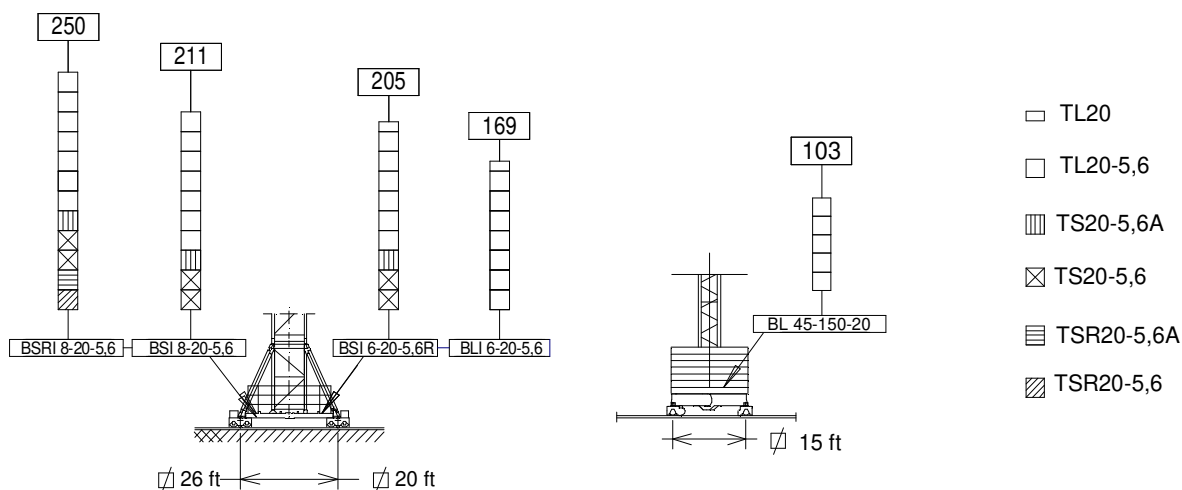

AL20	153.21.800
AS20	160.21.010
ASR20.....	160.21.200

BL45-150-20	171.20.200
BLI 6-20-5,6	211.20.500
BSI 6-20-5,6R	211.20.400

BSI 8-20-5,6.....	211.20.000
BSRI 8-20-5,6	204.20.000

ABH 100.....	201.23.000
ABH 100C	170.23.000

CARGAS / LOADS

J390

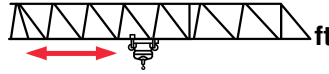

EXTRA Lift

ft	26500 lb @ ... (ft)	49	66	82	98	115	131	148	164	180	197	213	230	246	EXTRA Lift
		246	91 95	26500 26500	26500 26500	26500 26500	24300 25500	20500 21600	17600 18700	15400 16400	13700 14600	12200 13100	11000 11900	10000 10900	
230	94 98	26500 26500	26500 26500	26500 26500	25100 26300	21200 22300	18300 19300	16000 17000	14200 15100	12700 13600	11400 12400	10400 11300	9500 10400	— —	+
213	97 101	26500 26500	26500 26500	26500 26500	26000 26500	22000 23100	18900 20100	16600 17700	14700 15800	13200 14200	11900 12900	10800 11800	— —	— —	+
197	101 106	26500 26500	26500 26500	26500 26500	26500 24300	23100 21200	20000 18700	17500 16700	15500 15100	14600 13700	12600 —	— —	— —	— —	+
180	107 112	26500 26500	26500 26500	26500 26500	26500 24500	21100 22300	18500 19700	16500 17600	14800 15900	— —	— —	— —	— —	— —	+
164	112 117	26500 26500	26500 26500	26500 26500	26500 25800	22300 26500	19600 23500	17400 20700	— 18500	— —	— —	— —	— —	— —	+
148	117 122	26500 26500	26500 26500	26500 26500	26500 26500	26500 26500	23300 24500	20500 21500	— —	— —	— —	— —	— —	— —	+
131	120 125	26500 26500	26500 26500	26500 26500	26500 26500	26500 26500	24000 25100	— —	— —	— —	— —	— —	— —	— —	+
115	115 115	26500 26500	26500 26500	26500 26500	26500 26500	26500 26500	— —	— —	— —	— —	— —	— —	— —	— —	+
98	98 98	26500 26500	26500 26500	26500 26500	26500 26500	— —	— —	— —	— —	— —	— —	— —	— —	— —	+

CARGAS / LOADS

J390

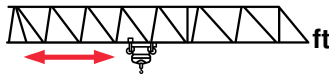

EXTRA Lift

ft	26500 lb @ ... (ft)	49	66	82	98	115	131	148	164	180	197	213	230	246	EXTRA Lift
		246	86/46 88/47	26500/49100 26500/50200	26500/35800 26500/36800	26500/27800 26500/28800	22500 23400	18700 19600	15900 16700	13700 14400	11900 12700	10500 11200	9300 10000	8200 8900	
230	88/47 91/48	26500/50700 26500/51900	26500/37000 26500/38100	26500/28800 26500/29800	23300 24300	19400 20300	16500 17350	14200 15000	12400 13200	10900 11700	9700 10400	8600 9400	7700 8500	— —	+
213	91/49 94/50	26500/52500 26500/52900	26500/38400 26500/39500	26500/29900 26500/30900	24300 25200	20200 21100	17200 18100	14800 15700	12900 13800	11400 12300	10100 11000	9000 9900	— —	— —	+
197	96/51 99/52	26500/52900 26500/52900	26500/40400 26500/41500	26500/31500 26500/32600	25600 26700	21400 22400	18200 19200	15700 16800	13800 14800	12100 13100	10800 11800	— —	— —	— —	+
180	97/54 105/55	26500/52900 26500/52900	26500/42800 26500/43900	26500/33400 26500/34600	26500/27200 23900	22700 23900	19400 20500	16800 17924	14700 15800	13000 14100	— —	— —	— —	— —	+
164	106/57 110/58	26500/52900 26500/52900	26500/45100 26500/46300	26500/35300 26500/36500	26500/28700 26500/29900	24100 25300	20600 21800	17800 19026	15700 16850	— —	— —	— —	— —	— —	+
148	110/59 115/60	26500/52900 26500/52900	26500/47200 26500/48300	26500/36900 26500/38100	26500/30100 26500/31300	25200 26400	21600 22800	18700 19950	— —	— —	— —	— —	— —	— —	+
131	113/61 118/62	26500/52900 26500/52900	26500/48500 26500/49700	26500/38000 26500/39200	26500/31000 26500/32200	26000 27200	22300 23500	— —	— —	— —	— —	— —	— —	— —	+
115	115/62 115/63	26500/52900 26500/52900	26500/49700 26500/50800	26500/38900 26500/40100	26500/31800 26500/33000	26500/26700 26500/27800	— —	— —	— —	— —	— —	— —	— —	— —	+
98	98/63 98/65	26500/52900 26500/52900	26500/50900 26500/52100	26500/39900 26500/41100	26500/32600 26500/33700	— —	— —	— —	— —	— —	— —	— —	— —	— —	+

Datos válidos para / Valid data for H ≤ 230 ft

FEM 1005 - C25



Reservado el derecho a modificaciones sin previo aviso. Declinamos toda responsabilidad derivada de la información proporcionada / Subject to modification, without prior notice. This information is supplied without liability

***EC6080VF**
45 kW



EC88115VF
65 kW

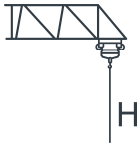
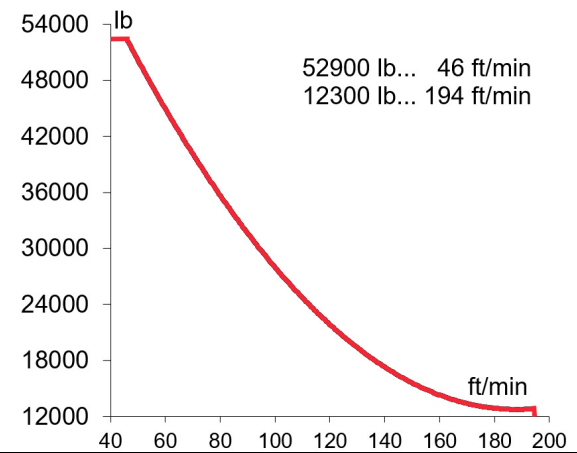
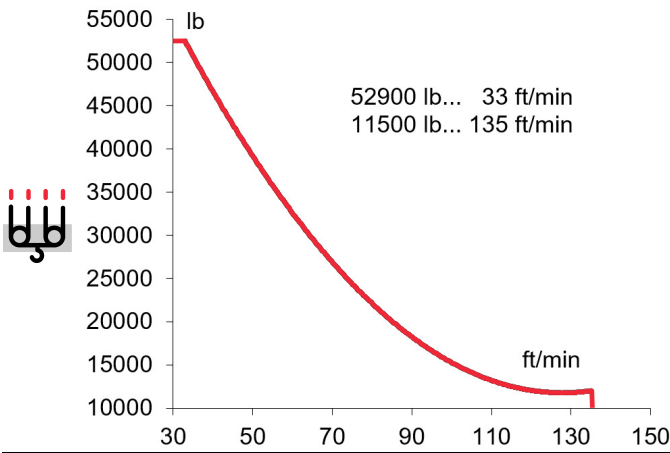
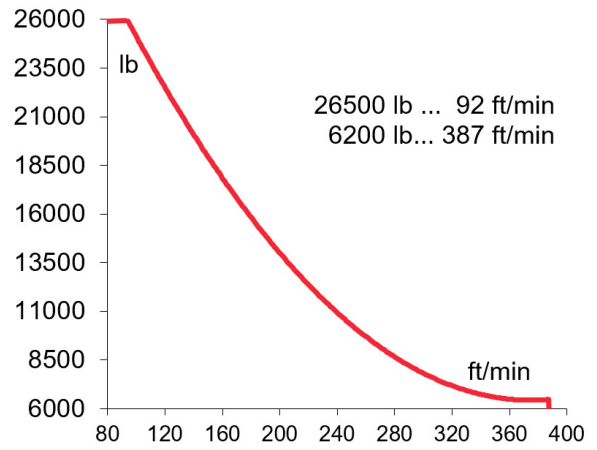
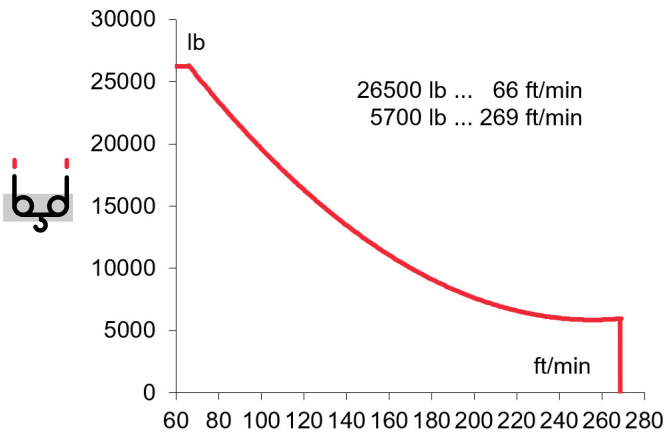

$H \leq \begin{matrix} \text{SR} & 1017 \text{ ft} \\ \text{DR} & 509 \text{ ft} \end{matrix}$

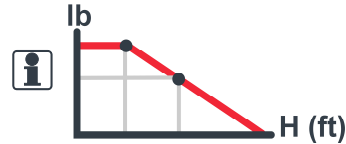

<p>OG2208VF 3 x 5,5 kW</p>	<p>TC1595VF 11 kW</p>	<p>TG4025VF 4 x 7,5 kW</p>	<p>TH2006 15 kW</p>
<p>0...0,8 r/min sl/min</p>	<p><u>26500 lb</u> 0...308 ft/min <u>52900 lb</u> 0...154 ft/min</p>	<p>0...82 ft/min</p>	<p>2 ft/min</p>

3~ 400V 50Hz
480V 60Hz



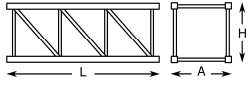
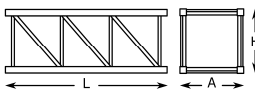
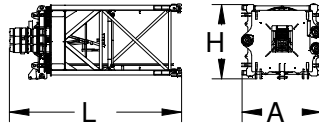
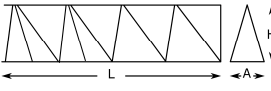
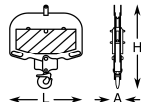
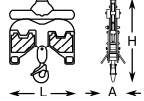
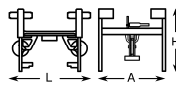
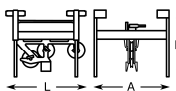
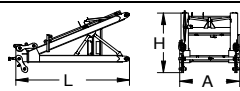
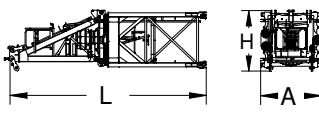
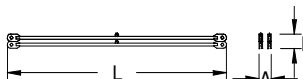

KVA			
EC6080VF	58	71	84
EC88115VF	64	79	95

			L (ft)	A (ft)	H (ft)	P/W (lb)
Torre inferior / Lower tower	TLI20-5,6		19.3	7.6	7.7	9340
	TSI20-5,6		19.6	7.6	7.8	11880
	TSRI20-5,6		19.7	7.4	7.4	14470
	TRID24-5,6		19.7	10.5	10.5	18520
Torre / Tower	TL20		13.7	7.2	7.5	4620
	TL20-5,6		19.3	7.6	7.7	6415
	TS20-5,6A		19.6	7.8	7.6	7780
	TS20-5,6		19.6	7.6	7.8	7830
	TSR20-5,6A		19.4	7.8	7.6	9200
	TSR20-5,6		19.7	7.4	7.4	9290
	TR24-5,6		19.7	9.1	9.3	10490
	TRD24-5,6		19.6	9.0	7.5	11640
Torre asiento pista + punta de torre + orientación Slewing table + tower head + slewing mechanism		17.5	8.2	8.3	16865	
Tramo de pluma Jib section	PT19-31		33.3	5.2	7.2	6810
	PT19-32+Tr		33.5	5.2	7.4	8060
	PT19-33		17.4	5.2	7.2	3680
	PT19-34		33.7	5.2	7.2	6300
	PT19-35		33.6	5.2	6.7	4920
	PT19-36		33.6	5.2	6.7	3570
	PT19-37		33.5	5.2	6.7	2480
	PT19-28		33.4	5.7	6.7	2130
	PP19-39		3.4	5.7	2.5	455
Polipasto / Hook assembly	SR - 26500 lb		4.4	1.0	4.3	880
	SR / DR - 52900 lb		4.9	1.3	5.5	1550
Carro / Trolley	SR - 26500 lb		7.6	7.9	5.3	1370
	SR / DR - 52900 lb		8.7	7.7	7.0	2460
Punta de torre / Tower head		12.0	6.5	6.5	5030	
Conjunto asiento pista, punta de torre, orientación Slewing table assembl +, tower head + slewing		26.6	8.2	8.3	21890	
Tirante sostén pluma / Jib support tie		21.5	5.9	1.1	7000	

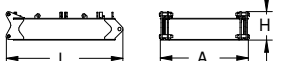
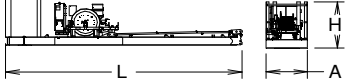
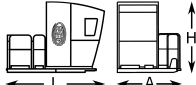

LISTA DE EMBARQUE / PACKING LIST

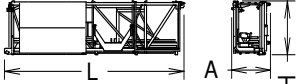
J390



		L (ft)	A (ft)	H (ft)	P/W (lb)	
Contrapluma / Counterjib	C0-19		15.6	6.4	1.7	5630
	C1-19		8.3	6.3	1.9	2120
Contrapluma con mecanismos (sin cable) + plumín auxiliar + armario eléctrico / Counterjib with mechanism (without rope) + auxiliary jib + electrical cabinet	C2-12		39.4	6.9	7.7	18960
Plataforma y cabina / Platform and cabin			11.5	6.8	7.9	2390
Armario eléctrico y plataforma			9.0	5.3	8.1	2230
Transporte torre de montaje Jacking cage transport	TM20PALF-5,6		32.7	6.1	8.3	14580
Contrapeso / Counterweight	Lastre / Ballast		12.5 12.5 12.5	1.9 0.9 0.6	4.9 4.9 4.9	13230 6600 4400

TREPADO / CLIMBING

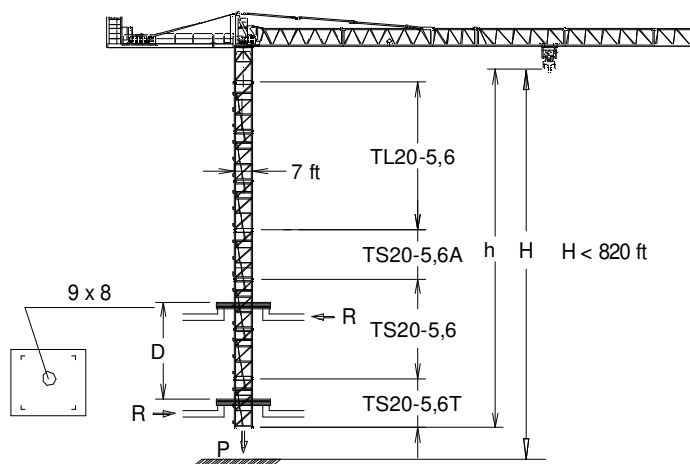
J390



h_{max} :
TS20-5,6T + 3xTS20-5,6 + TS20-5,6A + 4xTL20-5,6

		
98 ft		
h (ft)	152	
D (ft)	56 – 71	
P (lbf)	272020	218060
Rmax (lbf)	46760	103410
TS20-5,6T: 160.32.600		

i Trepado interno / Internal climbing

 **FEM 1005 - C25**



Reservado el derecho a modificaciones sin previo aviso. Declinamos toda responsabilidad derivada de la información proporcionada / Subject to modification, without prior notice. This information is supplied without liability

11/04/2025

T	H	Tower Composition				H	T	
1	23	TL20-5,6		TL20-5,6	TL20-5,6		23	1
2	42					18	42	2
3	60						60	3
4	78						78	4
5	97						97	5
6	115						115	6
7	134						134	7
8	152		TS20-5,6A	TS20-5,6A	TS20-5,6A	18	152	8
		AL20	TS20-5,6	TS20-5,6	TS20-5,6	18	170	9
					TR 24/TS20	4		
					TR 24-5,6	18	193	10
					TRD 24-5,6	18	211	11
				189		18	230	12
				207	TSR20-5,6A	18	248	13
				225	TSR20-5,6	18	266	14
				244				

T : Torre / Tower
H : Altura / Height

Otras configuraciones de torre / Other tower configuration

TRANSPORTE / TRANSPORT

J390



$$H = 8 \times TL20-5,6 + AL20 +$$

10 x



11 x



Viento fuera de servicio / Out of service wind



Consultar / Consult



En servicio / In service



Fuera de servicio / Out of service



Opcional / Optional



Ctra./ Rd. Madrid – Irún - Km. 415 - 20213 IDIAZABAL (Gipuzkoa) - ESPAÑA / SPAIN
P.O. Box, 23 - 20.200 - BEASAIN - E-mail: jaso@jaso.com
Tel. +34 943 - 18 70 00 • Fax. +34 943 - 18 70 20
www.jaso.com

11/04/2025



FEM 1005 - C25

DELEGACIÓN / DEALER