



J390

EN 14439
C25

GRUA TORRE / TOWER CRANE
GRUE A TOUR / TURMDREHKRAN / БАШЕННЫЙ КРАН / رافعة برجية

FEM 1005 - C25

UNE-EN-ISO 9001

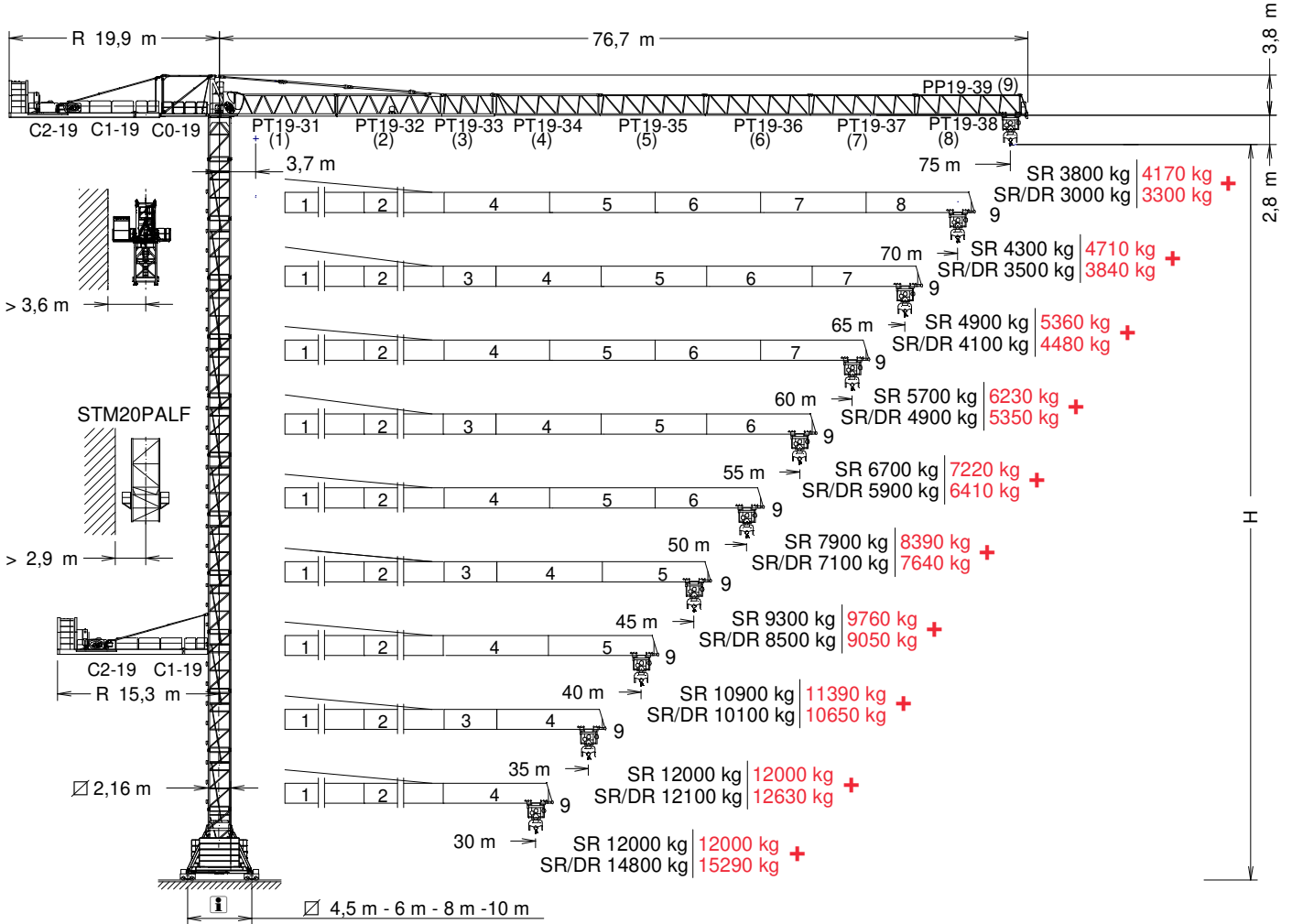

*OPTIONAL EXTRA LIFT

H= Altura máxima bajo gancho sin arriostrar (m). / Maximum height under hook without fastening (m). / Hauteur maximale sous crochet sans ancrage (m).
Max. Hakenhöhe ohne Verstreben (m). / Максимальная высота под крюком без крепления (m). / أقصى ارتفاع تحت الخطاف بدون ربط

PT19-31.....	166.40.600	PT19-35.....	166.44.600	PP19-39.....	166.47.900	TS20-5,6.....	204.31.200
PT19-32.....	166.41.600	PT19-36.....	166.45.600	TL20-5,6.....	204.31.400	TSR20-5,6A.....	206.31.300
PT19-33.....	166.42.600	PT19-37.....	166.46.200	TS20-5,6A.....	204.31.500	TSR20-5,6.....	206.31.000
PT19-34.....	166.43.600	PT19-38.....	166.47.300				

CUSTOMIZE YOUR CRANE

OPTIMUS
line JASD

EXTRA Lift	OPTI Cubo	TC Diagnosis SYSTEM	CLIMBING Solution	SAFETY Pack	Customization	ECO Mode	COMFORT Cabin	HIGH POWER Motors	JL25 Tower Crane Elevator	SMARTLINK BE SMART keep control



Reservado el derecho a modificaciones sin previo aviso. Declinamos toda responsabilidad derivada de la información proporcionada / Subject to modification, without prior notice. This information is supplied without liability / L'entreprise se réserve le droit de procéder à des modifications sans préavis. Nous déclinons toute responsabilité quant aux informations fournies / Das Recht auf Änderungen ohne vorherige Ankündigung bleibt vorbehalten. Wir übernehmen keine Gewähr für die gemachten Angaben / Мы оставляем за собой право на внесение изменений без предварительного уведомления. Мы снимаем с себя любую ответственность в отношении предоставленной информации / حقوق التغيير محفوظة دون إشعار مسبق دون أدنى مسؤولية عن المعلومات المقدمة

29/11/2024

(H) ESTACIONARIA 1 / STATIONARY 1 / STATIONAIRE 1 / STATIONÄR 1 / СТАЦИОНАРНОЕ СОСТОЯНИЕ / ثابتة

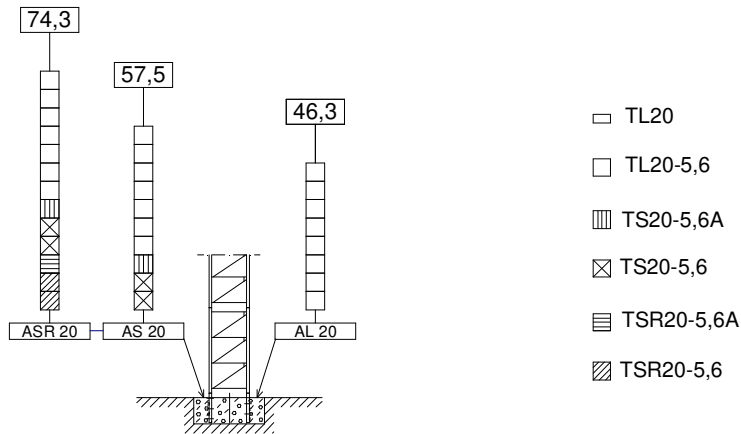

(H) ESTACIONARIA 3 / STATIONARY 3 / STATIONAIRE 3 / STATIONÄR 3 / СТАЦИОНАРНОЕ СОСТОЯНИЕ / ثابتة

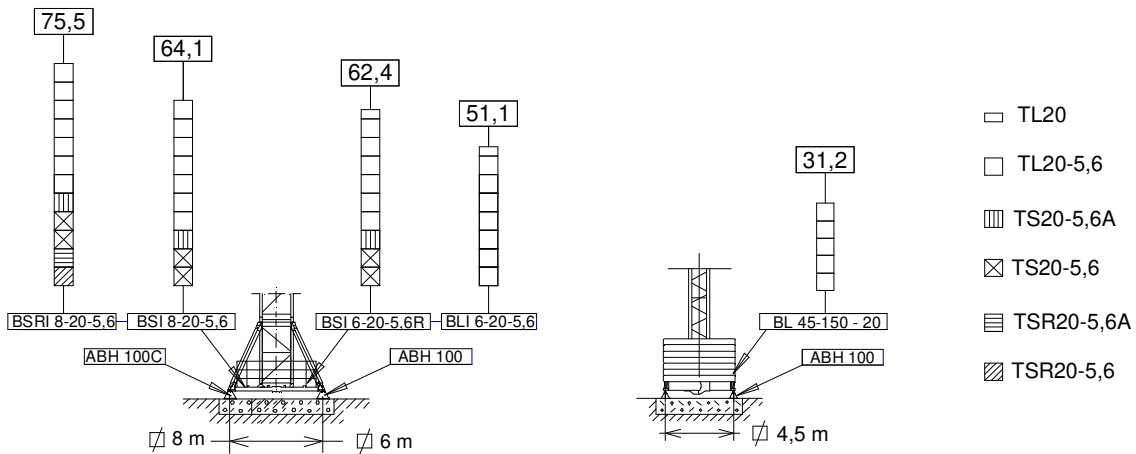

(H) TRASLACION / TRAVELLING / TRASLATION / FORTBEWEGUNG / ПЕРЕМЕЩЕНИЕ / متحركة

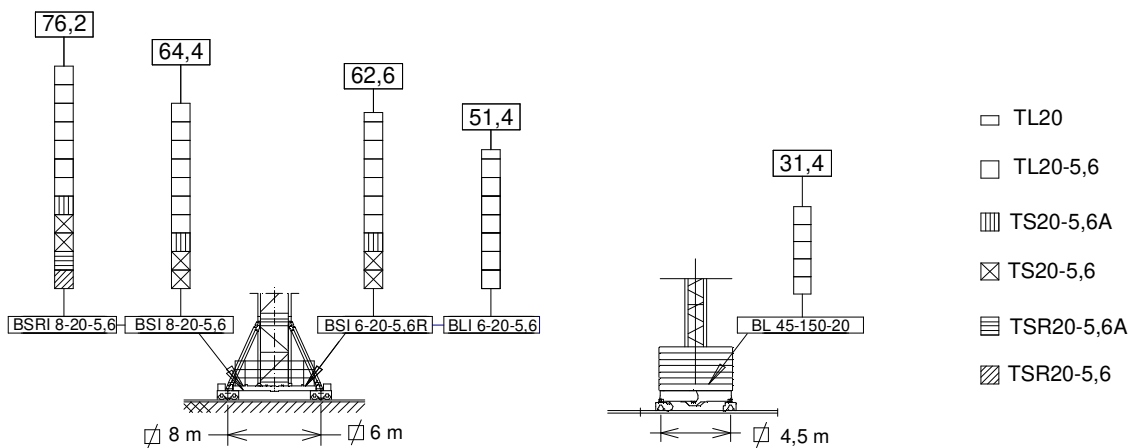

AL20	153.21.800
AS20	160.21.010
ASR20	160.21.200

BL45-150-20	171.20.200
BLI 6-20-5,6	211.20.500
BSI 6-20-5,6R	211.20.400

BSI 8-20-5,6	211.20.000
BSRI 8-20-5,6	204.20.000

ABH 100	201.23.000
ABH 100C	170.23.000

SR - 12 t																
12 t @ ... (m)	15	20	25	30	35	40	45	50	55	60	65	70	75	EXTRA Lift		
75	27,7 28,9	12,0	12,0	12,0	11,01 11,55	9,29 9,79	8,00 8,47	7,00 7,45	6,20 6,63	5,54 5,96	5,00 5,40	4,54 4,93	4,14 4,52	3,80 4,17	+	
70	28,6 29,8	12,0	12,0	12,0	11,37 11,92	9,60 10,12	8,28 8,77	7,24 7,72	6,42 6,87	5,74 6,19	5,18 5,61	4,70 5,13	4,30 4,71	—	+	
65	29,5 30,8	12,0	12,0	12,0	11,79 12,0	9,96 10,49	8,59 9,1	7,52 8,02	6,67 7,16	5,97 6,45	5,39 5,86	4,90 5,36	—	—	+	
60	30,9 32,3	12,0	12,0	12,0	12,0 12,0	10,49 11,04	9,05 9,6	7,93 8,47	7,04 7,58	6,31 6,84	5,70 6,23	—	—	—	+	
55	32,6 34,0	12,0	12,0	12,0	12,0 12,0	11,10 11,65	9,59 10,13	8,41 8,94	7,47 8,0	6,70 7,22	—	—	—	—	+	
50	34,2 35,8	12,0	12,0	12,0	12,0 12,0	11,71 12,0	10,12 10,66	8,89 9,40	7,90 8,39	—	—	—	—	—	+	
45	35,7 37,2	12,0	12,0	12,0	12,0 12,0	12,0 12,0	10,58 11,11	9,30 9,76	—	—	—	—	—	—	+	
40	36,6 38,2	12,0	12,0	12,0	12,0 12,0	12,0 12,0	10,90 11,39	—	—	—	—	—	—	—	+	
35	35,0 35,0	12,0	12,0	12,0	12,0 12,0	12,0 12,0	—	—	—	—	—	—	—	—	+	
30	30,0 30,0	12,0	12,0	12,0	12,0 12,0	—	—	—	—	—	—	—	—	—	+	

SR/DR 12 / 24 t																
12 - 24 t @ ... (m)	15	20	25	30	35	40	45	50	55	60	65	70	75	EXTRA Lift		
75	26,2/14,0 26,9/14,3	12,0/22,27 12,0/22,79	12,0/16,25 12,0/16,70	12,0/12,63 12,0/13,05	10,22 10,61	8,50 8,87	7,21 7,56	6,21 6,55	5,41 5,74	4,75 5,07	4,20 4,52	3,74 4,05	3,34 3,65	3,0 3,30	+	
70	26,9/14,4 27,8/14,7	12,0/23,0 12,0/23,53	12,0/16,79 12,0/17,26	12,0/13,07 12,0/13,50	10,59 11,0	8,81 9,21	7,48 7,87	6,45 6,82	5,62 5,99	4,95 5,30	4,38 4,73	3,90 4,25	3,50 3,84	—	+	
65	27,8/14,9 28,7/15,2	12,0/23,83 12,0/24,0	12,0/17,41 12,0/17,90	12,0/13,57 12,0/14,02	11,0 11,44	9,17 9,59	7,79 8,21	6,73 7,13	5,87 6,27	5,17 5,56	4,59 4,98	4,10 4,48	—	—	+	
60	29,2/15,6 30,2/15,9	12,0/24,0 12,0/24,0	12,0/18,33 12,0/18,84	12,0/14,30 12,0/14,80	11,61 12,0/12,10	9,69 10,17	8,26 8,72	7,14 7,60	6,24 6,70	5,51 5,96	4,90 5,35	—	—	—	+	
55	30,7/16,4 31,9/16,8	12,0/24,0 12,0/24,0	12,0/19,40 12,0/19,93	12,0/15,16 12,0/15,68	12,0/12,33 12,0/12,85	10,31 10,82	8,79 9,31	7,61 8,13	6,67 7,18	5,90 6,41	—	—	—	—	+	
50	32,3/17,3 33,6/17,6	12,0/24,0 12,0/24,0	12,0/20,47 12,0/21,01	12,0/16,01 12,0/16,55	12,0/13,04 12,0/13,58	10,92 11,46	9,33 9,87	8,09 8,63	7,10 7,64	—	—	—	—	—	+	
45	33,6/18,0 35,0/18,4	12,0/24,0 12,0/24,0	12,0/21,39 12,0/21,93	12,0/16,75 12,0/17,29	12,0/13,66 12,0/14,20	11,44 11,99	9,79 10,34	8,50 9,05	—	—	—	—	—	—	+	
40	34,5/18,5 35,9/18,8	12,0/24,0 12,0/24,0	12,0/22,01 12,0/22,55	12,0/17,25 12,0/17,79	12,0/14,07 12,0/14,62	11,80 12,0/12,35	10,10 10,65	—	—	—	—	—	—	—	+	
35	35,0/18,9 35,0/19,3	12,0/24,0 12,0/24,0	12,0/22,53 12,0/23,06	12,0/17,66 12,0/18,19	12,0/14,42 12,0/14,95	12,0/12,10 12,0/12,63	—	—	—	—	—	—	—	—	+	
30	30,0/19,3 30,0/19,7	12,0/24,0 12,0/24,0	12,0/23,11 12,0/23,63	12,0/18,12 12,0/18,63	12,0/14,80 12,0/15,29	—	—	—	—	—	—	—	—	—	+	

Datos válidos para / Valid data for
Donnees valables pour / Gultige Daten für / Допустимые данные для / البيانات الصالحة ل



FEM 1005 - C25



Reservado el derecho a modificaciones sin previo aviso. Declinamos toda responsabilidad derivada de la información proporcionada / Subject to modification, without prior notice. This information is supplied without liability / L'entreprise se réserve le droit de procéder à des modifications sans préavis. Nous déclinons toute responsabilité quant aux informations fournies / Das Recht auf Änderungen ohne vorherige Ankündigung bleibt vorbehalten. Wir übernehmen keine Gewähr für die gemachten Angaben / Мы оставляем за собой право на внесение изменений без предварительного уведомления. Мы снимаем с себя любую ответственность в отношении предоставленной информации / حقوق التغيير محفوظة دون إشعار مسبقين بدون أدنى مسؤولية عن المعلومات المقدمة

***EC6080VF**
45 kW



EC88115VF
65 kW

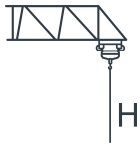
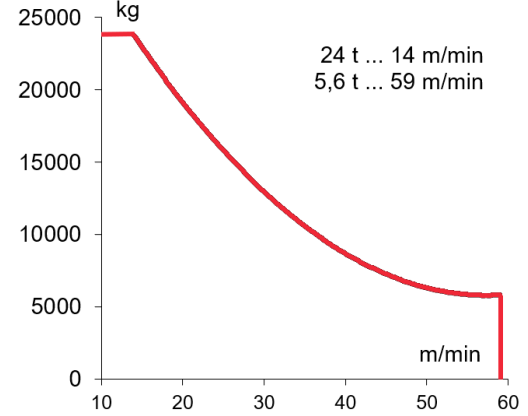
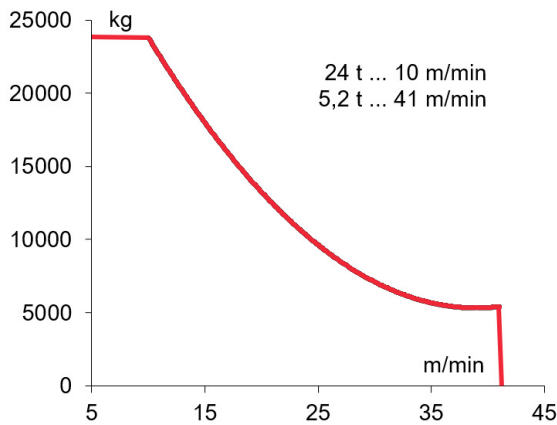
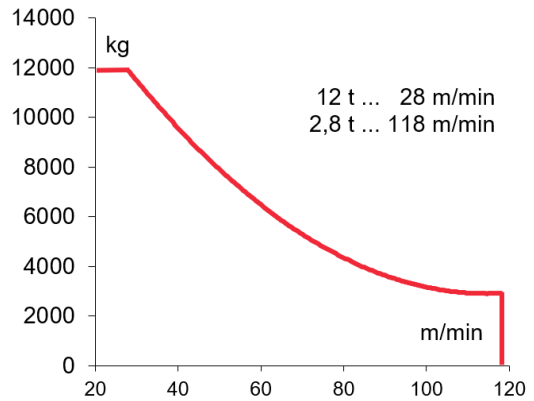
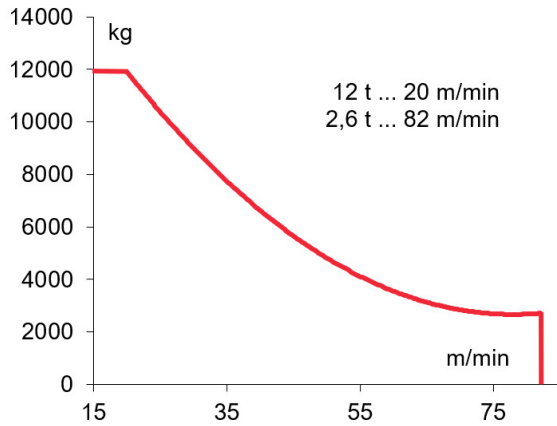

$H \leq$ SR 310 m
DR 155 m

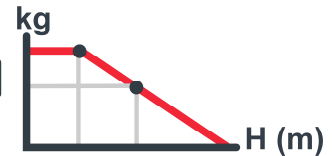

OG2208VF
3 x 5,5 kW



TC1595VF
11 kW

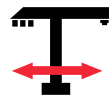

TG4025VF
4 x 7,5 kW



TH2006
15 kW

0...0,8
r/min
sl/min

12 t 0...94 m/min
24 t 0...47 m/min

0...25
m/min

0,6 m/min

3~ 400V 50Hz
480V 60Hz

KVA			
EC6080VF	58	71	84
EC88115VF	64	79	95

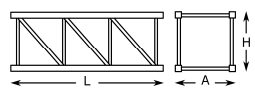
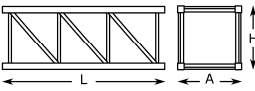
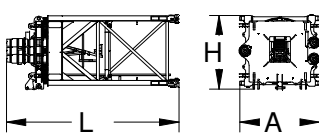
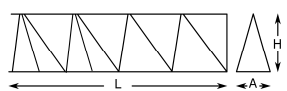
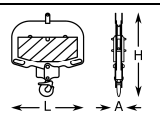
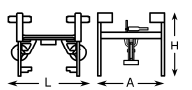
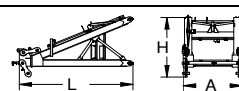
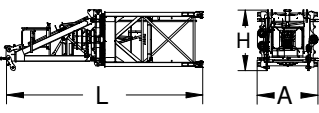
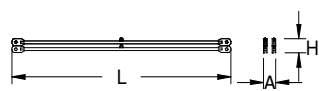

FEM 1005 - C25

			L (m)	A (m)	H (m)	P/W (kg)		
Torre inferior / Lower tower Tour inférieure / Unterer Turm Нижняя башня / البرج السفلي	TLI20-5,6		5,886	2,306	2,357	4235		
	TSI20-5,6		5,966	2,328	2,390	5390		
	TSRI20-5,6		5,990	2,257	2,257	6562		
	TRID24-5,6		5,990	3,202	3,202	8400		
Torre / Tower Tour / Turm / Башня / برج	TL20		4,175	2,201	2,281	2095		
	TL20-5,6		5,886	2,306	2,357	2910		
	TS20-5,6A		5,978	2,381	2,331	3530		
	TS20-5,6		5,966	2,328	2,390	3550		
	TSR20-5,6A		5,926	2,388	2,325	4170		
	TSR20-5,6		5,990	2,257	2,257	4210		
	TR24-5,6		5,990	2,760	2,835	4760		
TRD24-5,6	5,977	2,740	2,285	5280				
Torre asiento pista + punta de torre + orientación Slewing table + tower head + slewing mechanism Tour pivot + porte-flèche + mécanisme d'orientation Turmsitz + Turmspitze + Ausrichtung Сиденье площадки + верхней секции башни + поворотный механизм برج وحدة الدوارن + رأس البرج + آلية الدوران			5,319	2,51	2,52	7650		
	PT19-31		10,160	1,600	2,200	3090		
	PT19-32+Tr		10,225	1,600	2,270	3655		
	PT19-33		5,290	1,600	2,180	1670		
	PT19-34		10,270	1,600	2,180	2860		
Tramo de pluma Jib section Tronçon de flèche Auslegerabschnitt Секция стрелы أجزاء الذراع	PT19-35		10,250	1,600	2,050	2230		
	PT19-36		10,230	1,600	2,040	1620		
	PT19-37		10,210	1,600	2,040	1125		
	PT19-28		10,190	1,740	2,040	965		
	PP19-39		1,025	1,740	0,775	205		
	Polipasto / Hook assembly Palan / Flaschenzug Полиспаст / بكرة		SR - 12 t		1,350	0,300	1,300	400
			SR / DR - 24 t		1,490	0,400	1,680	705
Carro / Trolley Chariot / Laufkatze Грузовая тележка / عرب	SR - 12 t		2,320	2,420	1,610	620		
	SR / DR - 24 t		2,660	2,350	2,135	1115		
Punta de torre / Tower head / Porte-flèche Turmspitze / верхняя секция башни / رأس البرج			3,662	1,97	1,99	2280		
Conjunto asiento pista, punta de torre, orientación Slewing table assembl +, tower head + slewing Groupe pivot + porte-flèche + mécanisme d'orientation Gruppe Turmsitz + Turmspitze + Ausrichtung Сиденье площадки + верхняя секция башни + поворотный механизм مجموعة وحدة الدوارن + رأس البرج + آلية الدوران			8,120	2,51	2,52	9930		
Tirante sostén pluma / Jib support tie Tirant de fleche / Haltestange Ausleger Растяжка поддержки / مشد دعامة الذراع			6,540	1,785	0,335	3175		



			L (m)	A (m)	H (m)	P/W (kg)
Contrapluma / Counterjib Contre-flèche Gegenausleger Противовесная консоль / الذراع المعاكس	C0-19		4,760	1,960	0,510	2555
	C1-19		2,532	1,906	0,585	960
Contrapluma con mecanismos (sin cable) + plúmín auxiliar + armario eléctrico / Counterjib with mechanism (without rope) + auxiliary jib + electrical cabinet Contre-flèche avec mécanisme (sans cale) + fléchette auxiliaire + armoire électrique / Gegenausleger + Mechanismus (ohne Seil) + Ausleger + stromkasten / Противовесная консоль с механизмами (без троса) и вспомогательной дополнительной стрелой + Электрошкаф مع أليات (بدون كابل) وريشة مساعدة الذراع المعاكس	C2-12		12,00	2,100	2,355	8600
Plataforma y cabina / Platform and cabin Plateforme et cabine / Plattform + Führerstand Платформа и кабина / منصة وكابينة			3,520	2,060	2,400	1.085
Armario eléctrico y plataforma Electrical cabinet and platform / Armoire électrique et plateforme / Stromkasten + Plattform / الخزانة الكهربائية والمنصة			2,755	1,601	2,462	1010
Transporte torre de montaje Jacking cage transport Transport de tour de montage Transport Montageturm Транспортировка монтажной башни نقل برج التركيب	TM20PALF-5,6		9,955	1,851	2,525	6615
Contrapeso / Counterweight Contrepoids / Gegengewicht Противовес / اوزان معاكسة	Lastre / Ballast / Lest Ballast / Балласт / نقل ثقلي		3,800	0,580	1,500	6000
			3,800	0,275	1,500	3000
			3,800	0,180	1,500	2000

TREPADO / CLIMBING / TÉLESCOPAGE / KLETTERSYSTEM / ЛЕСТНИЦА / التسلق

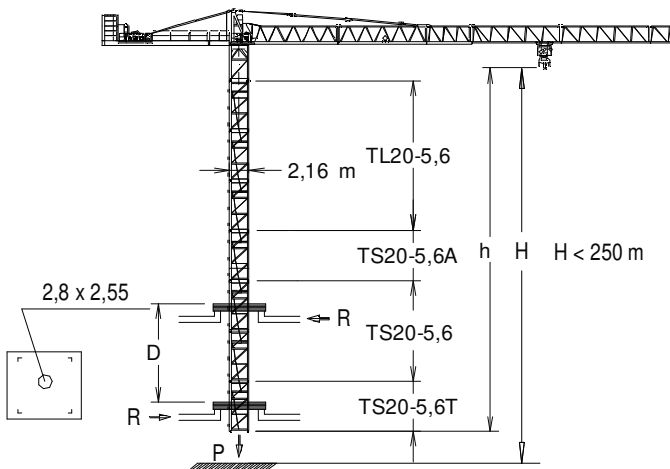

h _{max} :		
TS20-5,6T + 2xTS20-5,6 + TS20-5,6A + 4xTL20-5,6		
h (m)	46,3	
D (m)	17,2 – 21,7	
P (KN)	1210	970
R _{max} (KN)	208	460
TS20-5,6T: 160.32.600		

Trepado interno / Internal climbing / Téléscopage / Inneres klettersystem / Внутренняя лестница / التسلق الداخلي



FEM 1005 - C25



Reservado el derecho a modificaciones sin previo aviso. Declinamos toda responsabilidad derivada de la información proporcionada / Subject to modification, without prior notice. This information is supplied without liability / L'entreprise se réserve le droit de procéder à des modifications sans préavis. Nous déclinons toute responsabilité quant aux informations fournies / Das Recht auf Änderungen ohne vorherige Ankündigung bleibt vorbehalten. Wir übernehmen keine Gewähr für die gemachten Angaben / Мы оставляем за собой право на внесение изменений без предварительного уведомления. Мы снимаем с себя любую ответственность в отношении предоставленной информации / حقوق التغيير محفوظة دون إشعار مسبق. بدون أدنى مسؤولية عن المعلومات المقدمة

COMPOSICIONES DE TORRE / TOWER COMPOSITIONS

COMPOSITIONS DE LA TOUR / TURMZUSAMMENSETZUNGEN / КОНСТРУКЦИЯ БАШНИ / مكونات البرج

J390

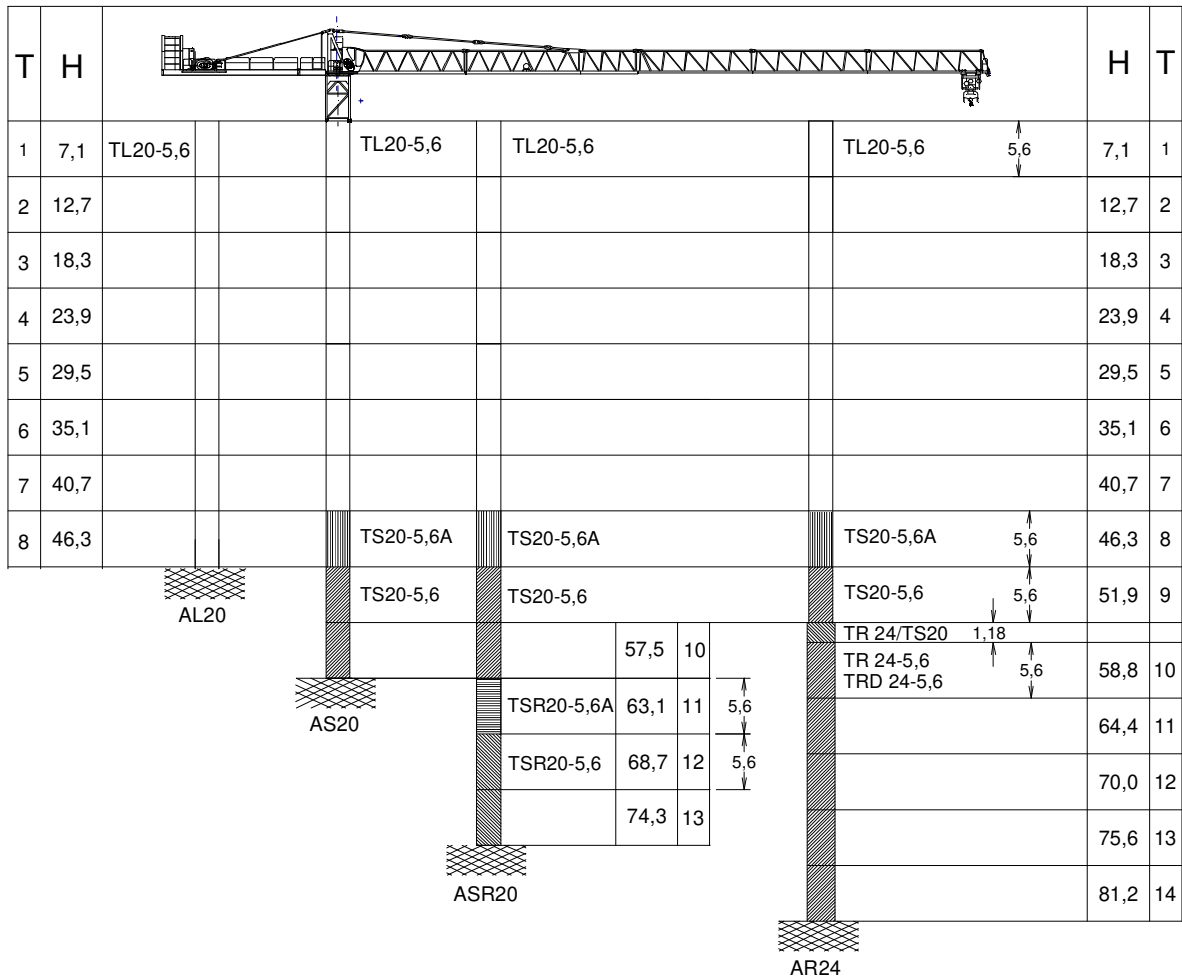

T : Torre / Tower / Tour / Turm / Башни / أبراج / ارتفاع
H : Altura / Height / Hauteur / Höhe / Высота / ارتفاع

TL20.....	153.31.000	TSR20-5,6A.....	206.31.300	TRD24-5,6.....	206.32.300	ASD 20/24.....	160.21.080
TL20-5,6.....	204.31.400	TSR20-5,6.....	206.31.000	AL 20.....	153.21.800	ASR 20.....	160.21.200
TS20-5,6A.....	204.31.500	TR24/TS20.....	156.36.400	ALD 20.....	160.21.250	ASRD 20/24.....	156.21.000
TS20-5,6.....	204.31.200	TR24-5,6.....	206.32.000	AS 20.....	160.21.010	AR24.....	156.21.200

i Otras configuraciones de torre / Other tower configuration / Autres configurations / Andere turmkonfigurationen / Прочие конфигурации / مكونات أخرى

TRANSPORTE / TRANSPORT / TRANSPORT / TRANSPORT / ТРАНСПОРТИРОВКА / نقل

J390



$$H = 8 \times \text{TL20-5,6} + \text{AL20} + \text{TRD}$$

10 x



11 x



i Viento fuera de servicio / Out of service wind / Vitesse du vent hors service / Wind außer betrieb / Ветровая нагрузка в покое / الريح خارج الخدمة

i Consultar / Consult / Nous consulter / Anfragen / Консультируйтесь / الرجوع إلى

▶ En servicio / In service / En service / In betrieb / В работе / في الخدمة

■ Fuera de servicio / Out of service / Hors service / Außer betrieb / В покое / خارج الخدمة

***** Opcional / Optional / En option / Optional / Опция / اختياري



Ctra./ Rd. Madrid – Irún - Km. 415 - 20213 IDIAZABAL (Gipuzkoa) - ESPAÑA / SPAIN
P.O. Box, 23 - 20.200 - BEASAIN - E-mail: jaso@jaso.com
Tel. +34 943 - 18 70 00 • Fax. +34 943 - 18 70 20
www.jaso.com

29/11/2024



FEM 1005 - C25

DELEGACIÓN / DEALER

Reservado el derecho a modificaciones sin previo aviso. Declinamos toda responsabilidad derivada de la información proporcionada / Subject to modification, without prior notice. This information is supplied without liability / L'entreprise se réserve le droit de procéder à des modifications sans préavis. Nous déclinons toute responsabilité quant aux informations fournies / Das Recht auf Änderungen ohne vorherige Ankündigung bleibt vorbehalten. Wir übernehmen keine Gewähr für die gemachten Angaben / Мы оставляем за собой право на внесение изменений без предварительного уведомления. Мы снимаем с себя любую ответственность в отношении предоставленной информации / حقوق التغيير محفوظة دون إشعار مسبق. دون أدنى مسؤولية عن المعلومات المقدمة