

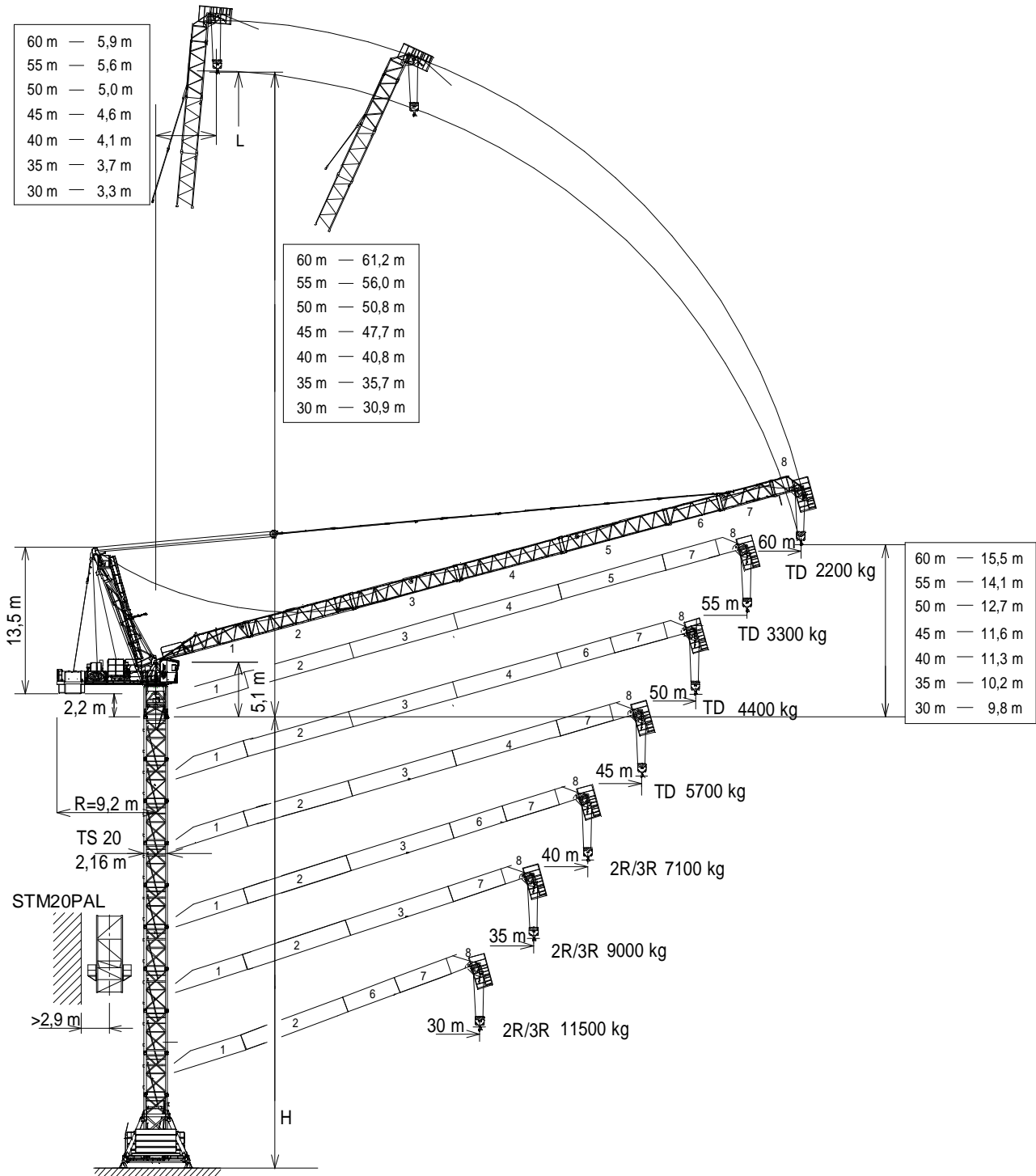

UNE 58-101
FEM 1001

UNE-EN-ISO 9001



H =

Máxima altura de torre sin arriostrar (m).
 Maximum tower height without fastening (m).
 Hauteur maximale de tour sans ancrage (m).
 Maximale Höhe ohne Verstreben (m).
 Максимальная высота башни без крепления (м).
 أقصى ارتفاع للبرج بدون ربط (م)

* Tramo pluma / Jib section / Tronçon de fleche
 Auslegerabschnitt / Секция стрелы / أجزاء الذراع

** Punta de pluma / Jib end / Pointe de fleche
 Auslegerspitze / Конец стрелы / مقدمة الذراع

*Tramo pluma 1 / Jib section 1	211.40.000
*Tramo pluma 2 / Jib section 2	211.41.000
*Tramo pluma 3 / Jib section 3	211.42.000
*Tramo pluma 4 / Jib section 4	211.43.000
*Tramo pluma 5 / Jib section 5	211.44.000
*Tramo pluma 6 / Jib section 6	211.45.000
*Tramo pluma 7 / Jib section 7	211.46.000
**Punta pluma 8 / Jib end 8	207.46.000

BSI6-20-5,6R	211.20.400
BSI8-20-5,6	211.20.000
TS20	153.31.600
TS20-5,6	204.31.200
TSR20-5,6	206.31.000
TSR20-5,6A	206.31.300
AS20	160.21.010
ASR20	160.21.200
ABH 100	201.23.000



Fecha / Date: 11/01/2023

Reservado el derecho a modificaciones sin previo aviso. Declinamos toda responsabilidad derivada de la información proporcionada / Subject to modification, without prior notice. This information is supplied without liability / L'entreprise se réserve le droit de procéder à des modifications sans préavis. Nous déclinons toute responsabilité quant aux informations fournies / Das Recht auf Änderungen ohne vorherige Ankündigung bleibt vorbehalten. Wir übernehmen keine Gewähr für die gemachten Angaben / Мы оставляем за собой право на внесение изменений без предварительного уведомления. Мы снимаем с себя любую ответственность в отношении предоставленной информации / حقوق التغيير محفوظة دون إشعار مسبق. دون أدنى مسؤولية عن المعلومات المقدمة.



(H) TRASLACIÓN / TRAVELLING

TRASLACION / FORTBEWEGUNG / ПЕРЕМЕЩЕНИЕ / متحركة

(H) ESTACIONARIA / STATIONARY

STATIONAIRE / STATIONÄR / СТАЦИОНАРНОЕ СОСТОЯНИЕ / ثابتة

61,1 30

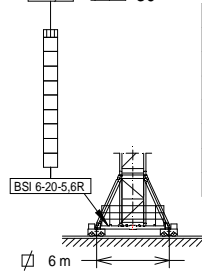

▽	H(m)	□	▣
30	61,1	9	1
35	57,3	9	-
40	55,5	8	1
45	51,7	8	-
50	49,9	7	1
55	46,1	7	-
60	44,4	6	1

61,9 30

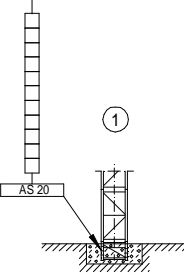

▽	H(m)	□	▣
30	61,9	11	-
35	60,2	10	1
40	56,3	10	-
45	56,3	10	-
50	54,6	9	1
55	50,7	9	-
60	49,0	8	1

61 30

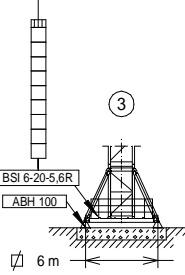

▽	H(m)	□	▣
30	61,0	9	1
35	57,2	9	-
40	55,4	8	1
45	51,6	8	-
50	49,8	7	1
55	46,0	7	-
60	44,3	6	1

- ▣ TS 20
- TS 20-5,6
- ▣ TSR 20-5,6A
- ▣ TSR 20-5,6

66,8 30

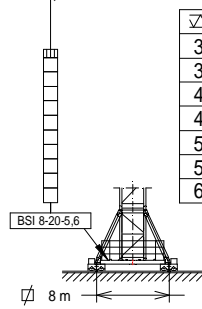

▽	H(m)	□	▣
30	66,8	10	1
35	63,0	10	-
40	61,2	9	1
45	57,4	9	-
50	57,4	9	-
55	55,6	8	1
60	51,7	8	-

73,1 30

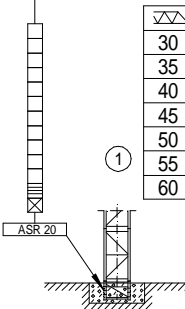

▽	H(m)	▣	▣	□	▣
30	73,1	1	1	11	-
35	73,1	2	1	10	-
40	71,4	2	1	9	1
45	67,5	2	1	9	-
50	65,8	2	1	8	1
55	61,9	1	1	9	-
60	61,9	2	1	8	-

66,6 30

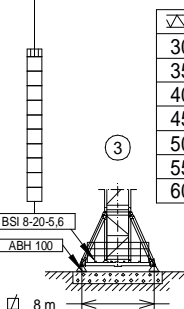

▽	H(m)	□	▣
30	66,6	10	1
35	62,8	10	-
40	61,0	9	1
45	57,2	9	-
50	57,2	9	-
55	55,4	8	1
60	51,6	8	-

TREPADO / CLIMBING / TÉLESCOPAGE / KLETTERSYSTEM / ЛЕСТНИЦА / التسلق

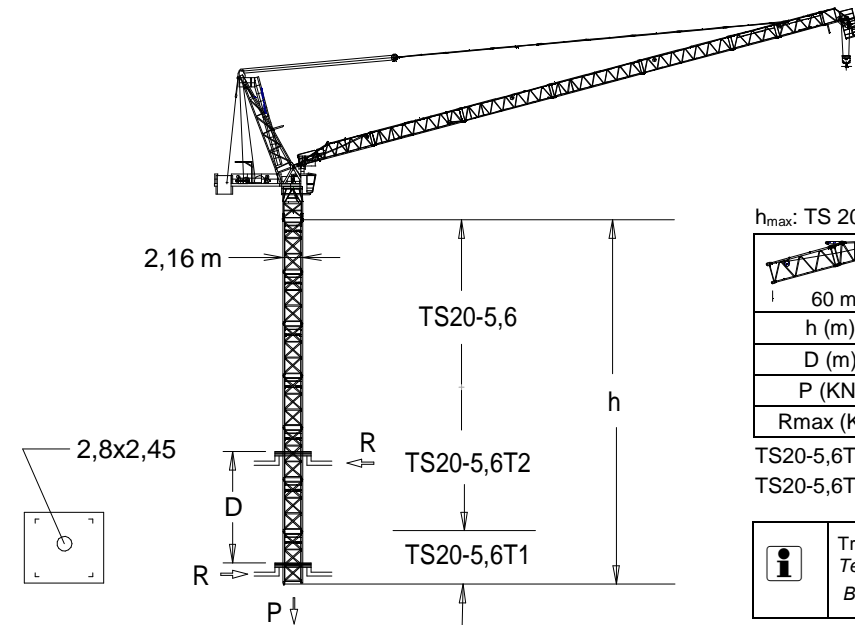

h_{max} : TS 20-5,6T1 + 5xTS 20-5,6 + TS 20-5,6T2

h (m)	39,5
D (m)	11 - 18
P (KN)	1224 1044
Rmax (KN)	371 551

TS20-5,6T1: 160.32.600



TS20-5,6T2: 160.32.700

i Trepado interno / Internal climbing
Télescopage intérieur / Inneres klettersystem
Внутренняя лестница / التسلق الداخلي

- 🚫 Viento fuera de servicio / Out of service wind / Vitesse du vent hors service / Wind außer betrieb / Ветровая нагрузка в покое / الريح خارج الخدمة
- 📄 Consultar / Consult / Nous consulter / Anfragen / Консультируйтесь / الرجوع إلى
- ▶ En servicio / In service / En service / In betrieb / В работе / في الخدمة
- Fuera de servicio / Out of service / Hors service / Außer betrieb / В покое / خارج الخدمة

Fecha / Date: 11/01/2023



 TD [t]		Cargas máximas / Maximum loads / Charges maximales / Höchstlasten / Максимальные нагрузки / أقصى حمولة TD – 6t							
 [m]	TD 6t @ (m)	Alcance del gancho [m] / Hook reach [m] Portée du crochet (m) / Reichweite des Hakens (m) / Радиус действия крюка (m) / مدى الخطاف							
		25	30	35	40	45	50	55	60
60	41,5	6,0	6,0	6,0	6,0	5,1	3,9	3,0	2,2
55	42,6	6,0	6,0	6,0	6,0	5,4	4,3	3,3	—
50	43,2	6,0	6,0	6,0	6,0	5,5	4,4	—	—
45	43,8	6,0	6,0	6,0	6,0	5,7	—	—	—
40	40,0	6,0	6,0	6,0	6,0	—	—	—	—
35	35,0	6,0	6,0	6,0	—	—	—	—	—
30	30,0	6,0	6,0	—	—	—	—	—	—















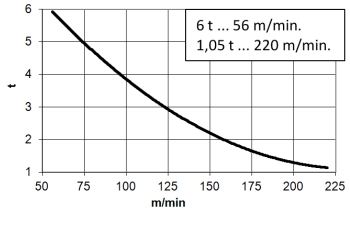
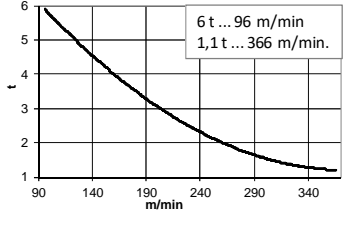

 TD/2R/3R [t]		Cargas máximas / Maximum loads / Charges maximales / Höchstlasten / Максимальные нагрузки / أقصى حمولة TD/2R/3R - 6t/12t/18t										
 [m]	3R 18t @...[m]	2R 12t @...[m]	TD 6t @...[m]	Alcance del gancho [m] / Hook reach [m] / Portée du crochet (m) / Reichweite des Hakens (m) / Радиус действия крюка (m) / مدى الخطاف								
				20	25	30	35	40	45	50	55	60
60	18t @...[m]	27,5	41,0	12,0	12,0	10,5	8,1	6,3	4,9	3,8	2,8	2,0
55		27,9	42,0	12,0	12,0	10,7	8,4	6,6	5,2	4,1	3,1	—
50	20,9	28,1	42,6	18,0	14,2	10,9	8,5	6,8	5,4	4,2	—	—
45	20,9	28,2	43,1	18,0	14,2	11,0	8,7	6,9	5,5	—	—	—
40	21,1	28,6	40,0	18,0	14,4	11,2	8,9	7,1	—	—	—	—
35	21,1	28,8	35,0	18,0	14,5	11,3	9,0	—	—	—	—	—
30	21,3	29,1	30,0	18,0	14,7	11,5	—	—	—	—	—	—

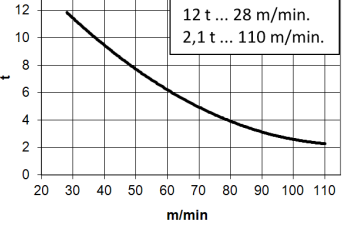
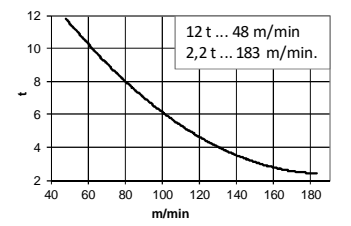

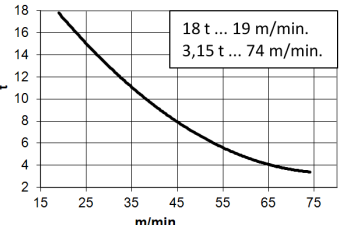
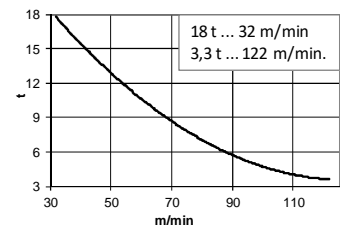
Fecha / Date: 11/01/2023

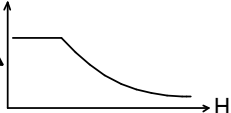
 FEM 1001

Reservado el derecho a modificaciones sin previo aviso. Declinamos toda responsabilidad derivada de la información proporcionada / Subject to modification, without prior notice. This information is supplied without liability / L'entreprise se réserve le droit de procéder à des modifications sans préavis. Nous déclinons toute responsabilité quant aux informations fournies / Das Recht auf Änderungen ohne vorherige Ankündigung bleibt vorbehalten. Wir übernehmen keine Gewähr für die gemachten Angaben / Мы оставляем за собой право на внесение изменений без предварительного уведомления. Мы снимаем с себя любую ответственность в отношении предоставленной информации / حقوق التغيير محفوظة دون إشعار مسبق. دون أدنى مسؤولية عن المعلومات المقدمة

<p>*opcional *optional *en option *optional *опция *اختياري</p>						
	<p>EC88110VF 65 kW</p>	<p>*EC150185VF 110 kW</p>	<p>OG1507VF 2x5,5 kW</p>	<p>EP6015VF 44,1 kW</p>	<p>TG2020VF 2x7,3 kW</p>	<p>TH2006 15 kW</p>
	 <p>6 t ... 56 m/min. 1,05 t ... 220 m/min.</p>	 <p>6 t ... 96 m/min 1,1 t ... 366 m/min.</p>	<p>0...0,8 r/min sl/min</p>	<p>1,5 min</p>	<p>0...20 m/min</p>	<p>0,6 m/min</p>
	 <p>12 t ... 28 m/min. 2,1 t ... 110 m/min.</p>	 <p>12 t ... 48 m/min 2,2 t ... 183 m/min.</p>	 400V 50Hz P_{TOTAL}(EC88110VF + OG1507VF + EP6015VF) = 120,1 kW P_{TOTAL}(EC150185VF + OG1507VF + EP6015VF) = 165,1 kW			
	 <p>18 t ... 19 m/min. 3,15 t ... 74 m/min.</p>	 <p>18 t ... 32 m/min 3,3 t ... 122 m/min.</p>	  			
	<p>H ≤ TD 630 m 2R 315 m 3R 210 m</p>		 845 m	 ecoMode		

LISTA DE EMBARQUE / PACKING LIST / LISTE DE COLISAGE / KOLLI LISTE / СПИСОК ПОСТАВКИ / قائمة التحميل J265PA

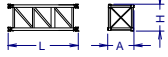
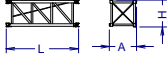
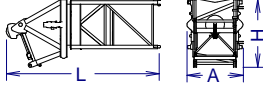
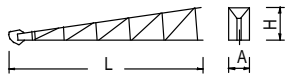
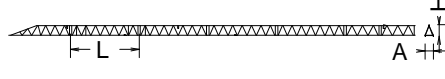
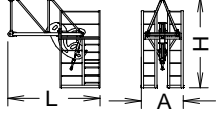
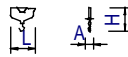
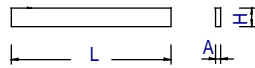
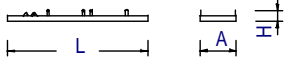
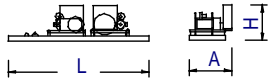
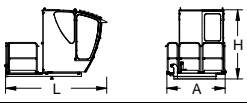
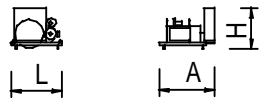
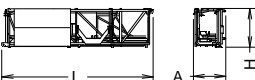
DENOMINACIÓN / DENOMINATION / DÉSIGNATION / BEZEICHNUNG / НАЗВАНИЕ / اسم		L [m]	A [m]	H [m]	P / W [kg]	
Torre inferior / Lower tower / Tour inférieure Unterer Turm / Нижняя башня / البرج السفلي	TSI20-5,6		5,966	2,328	2,390	5390
Torre / Tower Tour / Turm / Башня / برج	TS20		4,236	2,335	2,348	2690
	TS20-5,6		5,966	2,328	2,390	3550
	TSR20-5,6A		5,926	2,388	2,325	4170
	TSR20-5,6		5,990	2,257	2,257	4210
	TR24-5,6		5,990	2,760	2,835	4760
Torre asiento pista + base punta de torre + orientación Slewing table + tower head base + slewing mechanism Tour pivot + base du porte-flèche + mécanisme d'orientation Turmsitz + Turmspitzenbasis + Ausrichtung Сиденье площадки + основание верхней секции башни + поворотный механизм برج وحدة الدوران + قاعدة رأس البرج + آلية الدوران			5,918	2,675	3,085	9900
Punta de torre + pasteca Tower head + reeving block Structure de porte-flèche + moufle et fléchette Turmspitze + Unterflasche			11,663	1,910	2,033	6000
Tramo de pluma Jib section Tronçon de flèche Auslegerabschnitt Секция стрелы أجزاء الذراع	(1) (2) (3) (4) (5) (6) (7)		9,250	2,090	1,770	1580
			10,200	1,266	1,604	1490
			10,200	1,266	1,597	1373
			10,200	1,266	1,577	1225
			10,200	1,266	1,577	1171
			5,310	1,266	1,577	682
			5,293	1,266	1,630	926
Punta de pluma / Jib end / Pointe de flèche Auslegerspitze / Конец стрелы / مقدمة الذراع			3,420	1,580	3,585	880
Polipasto / Hook assembly Palan / Flaschenzug / Полиспаст / بكرة			0,918	0,394	1,218	440
Tirante sostén pluma / Jib support tie / Tirant de fleche Haltestange Ausleger / Растяжка поддержки стрелы مشد دعامة الذراع			5,842	0,360	0,370	1115
Estructura contrapluma / Counterjib structure / Structure de contre-flèche/ Konstruktion des Gegenauslegers / Структура противовесной / الذراع المعاكس			7,765	1,925	0,725	1437
Contrapluma con mecanismos / Counterjib with mechanisms Contre-flèche avec mécanismes / Gegenausleger + Mechanismus / Противовесная консоль с механизмами الذراع المعاكس مع الآليات			7,765	2,230	2,390	11800
Plataforma y cabina / Platform and cabin / Plateforme et cabin Plattform + Führerstand / Платформа и кабина / منصة وكابينة			3,420	2,060	2,400	1095
Mecanismos Elevación carga / Hoisting / Levage de charge Mechanisms Hebewerk / Подъем груза / رافع الحمولة			2,372	2,062	2,077	6200
Mécanismes de Elevación pluma / Luffing / Relevage de flèche Mechanismus Auslegerhebewerk / Подъем стрелы / رافع آليات كهربائية الذراع			1,967	2,631	1,895	3200
Transporte torre de montaje/ Jacking cage transport / Transport de tour de montage / Transport Montageturm Транспортировка монтажной башни / نقل برج التركيب	TM 20PAL-5,6		9,550	2,070	2,520	5690



Fecha / Date: 11/01/2023

Reservado el derecho a modificaciones sin previo aviso. Declinamos toda responsabilidad derivada de la información proporcionada / Subject to modification, without prior notice. This information is supplied without liability / L'entreprise se réserve le droit de procéder à des modifications sans préavis. Nous déclinons toute responsabilité quant aux informations fournies / Das Recht auf Änderungen ohne vorherige Ankündigung bleibt vorbehalten. Wir übernehmen keine Gewähr für die gemachten Angaben / Мы оставляем за собой право на внесение изменений без предварительного уведомления. Мы снимаем с себя любую ответственность в отношении предоставленной информации / المقدمة المعلومات عن مسؤولية دون إشعار مسبق. حقوق التغيير محفوظة دون إشعار مسبق.

FEM 1001

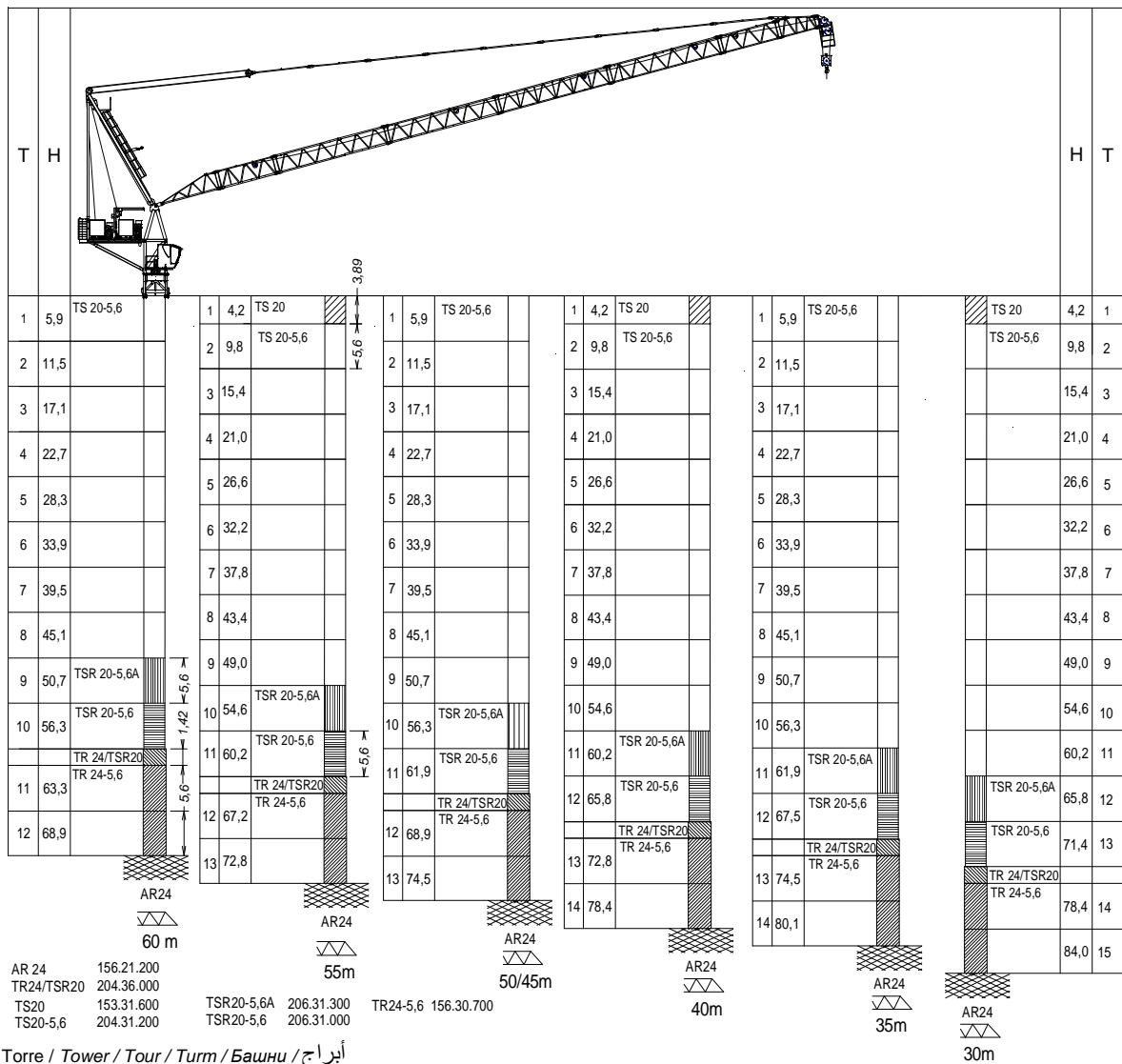

T: Torre / Tower / Tour / Turm / Башни / أبراج / ارتفاع
 H: Altura / Height / Hauteur / Höhe / Высота / ارتفاع



Otras configuraciones de torre / Other tower configuration
 Autres configurations / Andere turmkonfigurationen / Прочие конфигурации / مكونات أخرى

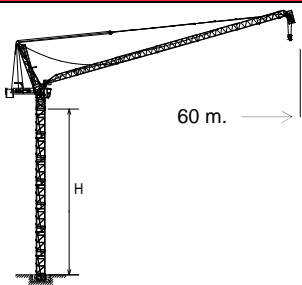

H = 49 m + AS20

8 x



7 x

HIGH CUBE 40'

+ 1 x

FLAT RACK 40'

Ancho 2,4m wide



Ctra./Rd. Madrid - Irún Km. 415 - 20.213 IDIAZABAL [Gipuzkoa] ESPAÑA / SPAIN
 P.O. Box, 23 - 20.200 BEASAIN - E-mail: jaso@jaso.com
 Tel. +34 943 - 18 70 00 • Fax. +34 943 - 18 70 20
www.jaso.com

Fecha / Date: 11/01/2023

FEM 1001

DELEGACION / DEALER

Reservado el derecho a modificaciones sin previo aviso. Declinamos toda responsabilidad derivada de la información proporcionada / Subject to modification, without prior notice.
 This information is supplied without liability / L'entreprise se réserve le droit de procéder à des modifications sans préavis. Nous déclinons toute responsabilité quant aux informations
 fournies / Das Recht auf Änderungen ohne vorherige Ankündigung bleibt vorbehalten. Wir übernehmen keine Gewähr für die gemachten Angaben / Мы оставляем за собой право
 на внесение изменений без предварительного уведомления. Мы снимаем с себя любую ответственность в отношении предоставленной информации

حقوق التغيير محفوظة دون إشعار مسبق. دون أدنى مسؤولية عن المعلومات المقدمة