



EN 14439
C25

J1400

GRUA TORRE / TOWER CRANE

GRUE A TOUR / TURMDREHKRAN / БАШЕННЫЙ КРАН / رافعة برجية

FEM 1005 - C25

UNE-EN-ISO 9001

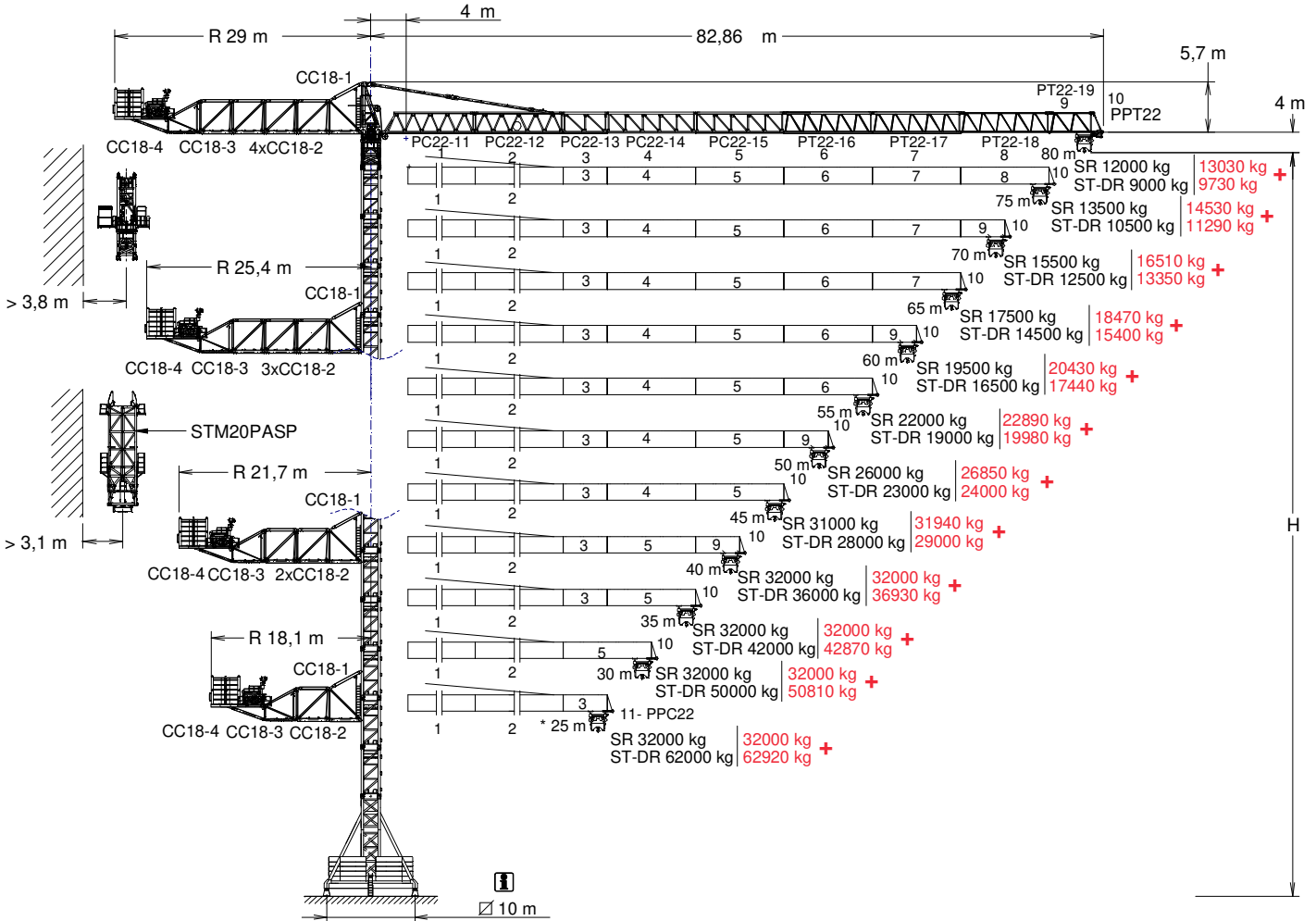

*OPTIONAL EXTRA LIFT

H= **Altura máxima bajo gancho sin arriostrar (m) / Maximum height under hook without fastening (m) / Hauteur maximale sous crochet sans ancrage (m).**
Max. Hakenhöhe ohne Verstreben (m) / Максимальная высота под крюком без крепления (m) / (م) أقصى ارتفاع تحت الخطاف بدون ربط

PC22-11.....	169.40.000	PC22-15.....	169.44.000	PT22-19.....	169.48.000	TSP20.....	214.31.300
PC22-12.....	169.41.000	PT22-16.....	169.45.000	PPT22.....	169.48.200	TSP20-5,6.....	214.31.100
PC22-13.....	169.42.000	PT22-17.....	169.46.000	PPC22.....	169.48.400	TSP24-5,6.....	214.32.200
PC22-14.....	169.43.000	PT22-18.....	169.47.000			TSP24/TSP20.....	212.36.000

CUSTOMIZE YOUR CRANE

OPTIMUS
line JASD

EXTRA Lift	OPTI Cube	TC Diagnosis SYSTEM	CLIMBING Solution	SAFETY Pack	Customization	ECO Mode	COMFORT Cabin	HIGH POWER Motors	JL25 Tower Crane Elevator	SMARTLINK BE SMART keep control



Reservado el derecho a modificaciones sin previo aviso. Declinamos toda responsabilidad derivada de la información proporcionada / Subject to modification, without prior notice. This information is supplied without liability / L'entreprise se réserve le droit de procéder à des modifications sans préavis. Nous déclinons toute responsabilité quant aux informations fournies / Das Recht auf Änderungen ohne vorherige Ankündigung bleibt vorbehalten. Wir übernehmen keine Gewähr für die gemachten Angaben / Мы оставляем за собой право на внесение изменений без предварительного уведомления. Мы снимаем с себя любую ответственность в отношении предоставленной информации / حقوق التغيير محفوظة دون إشعار مسبق. بدون أدنى مسؤولية عن المعلومات المقدمة

29/11/2024

(H) ESTACIONARIA 1 / STATIONARY 1 / STATIONAIRE 1 / STATIONÄR 1 / СТАЦИОНАРНОЕ СОСТОЯНИЕ / ثابتة

SR

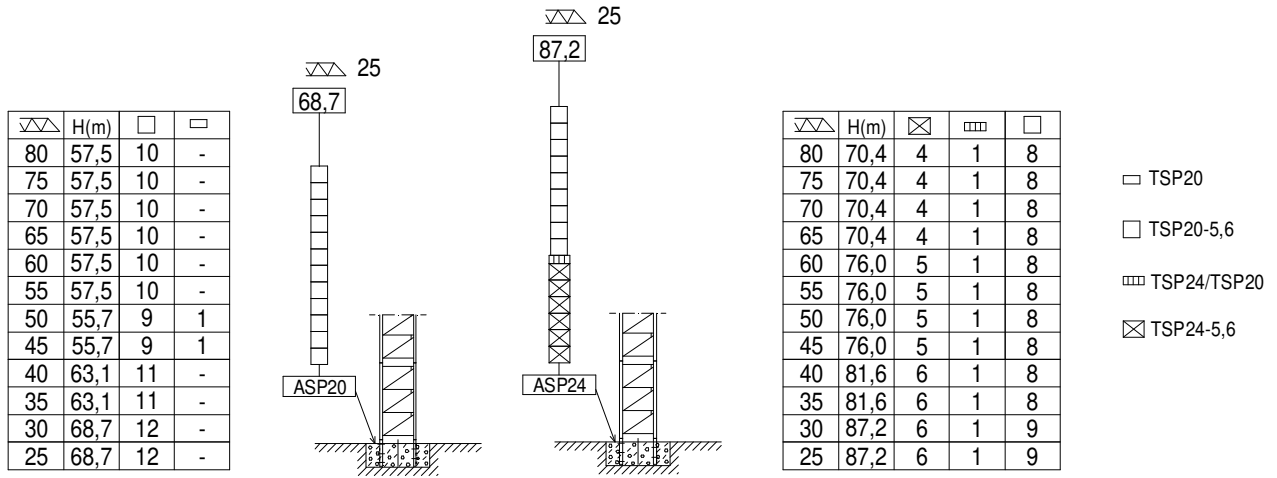

ST-SR / ST-DR

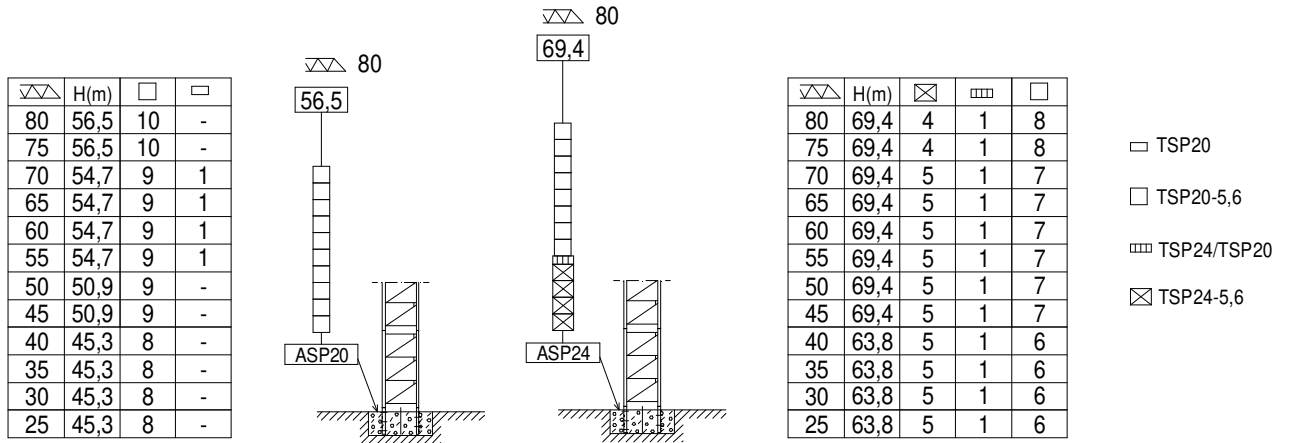

ASP20 212.21.200

ASP24..... 212.21.500



SR - 32 t

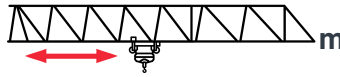

EXTRA Lift

	32 t @ ...(m)	25	30	35	40	45	50	55	60	65	70	75	80	
80	34,2	32,00	32,00	31,22	26,95	23,63	20,97	18,80	16,98	15,45	14,14	13,00	12,00	+
	35,2	32,00	32,00	32,00	27,94	24,63	21,98	19,81	18,00	16,47	15,16	14,02	13,03	
75	35,3	32,00	32,00	32,00	27,89	24,47	21,73	19,48	17,61	16,03	14,68	13,50	—	+
	36,3	32,00	32,00	32,00	28,89	25,47	22,73	20,49	18,63	17,05	15,70	14,53	—	
70	37,0	32,00	32,00	32,00	29,34	25,75	22,88	20,53	18,58	16,92	15,50	—	—	+
	38,0	32,00	32,00	32,00	30,33	26,74	23,88	21,53	19,58	17,92	16,51	—	—	
65	38,0	32,00	32,00	32,00	30,28	26,59	23,64	21,22	19,20	17,50	—	—	—	+
	39,1	32,00	32,00	32,00	31,27	27,57	24,61	22,20	20,18	18,47	—	—	—	
60	38,5	32,00	32,00	32,00	30,73	26,98	23,99	21,54	19,50	—	—	—	—	+
	39,7	32,00	32,00	32,00	31,71	27,95	24,94	22,48	20,43	—	—	—	—	
55	39,3	32,00	32,00	32,00	31,36	27,54	24,50	22,00	—	—	—	—	—	+
	40,4	32,00	32,00	32,00	32,00	28,49	25,41	22,89	—	—	—	—	—	
50	41,4	32,00	32,00	32,00	32,00	29,22	26,00	—	—	—	—	—	—	+
	42,6	32,00	32,00	32,00	32,00	30,15	26,85	—	—	—	—	—	—	
45	43,7	32,00	32,00	32,00	32,00	31,00	—	—	—	—	—	—	—	+
	45,0	32,00	32,00	32,00	32,00	31,94	—	—	—	—	—	—	—	
40	40,0	32,00	32,00	32,00	32,00	—	—	—	—	—	—	—	—	+
	40,0	32,00	32,00	32,00	32,00	—	—	—	—	—	—	—	—	
35	35,0	32,00	32,00	32,00	—	—	—	—	—	—	—	—	—	+
	35,0	32,00	32,00	32,00	—	—	—	—	—	—	—	—	—	
30	30,0	32,00	32,00	—	—	—	—	—	—	—	—	—	—	+
	30,0	32,00	32,00	—	—	—	—	—	—	—	—	—	—	
25	25,0	32,00	—	—	—	—	—	—	—	—	—	—	—	+
	25,0	32,00	—	—	—	—	—	—	—	—	—	—	—	

Datos válidos para / Valid data for

Donnees valables pour / Gultige Daten für / Допустимые данные для / البيانات الصالحة لـ









H ≤ 70 m

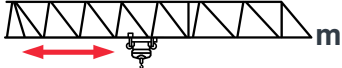

FEM 1005 – C25

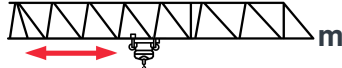

 ST-SR 32 t														 EXTRA Lift
	32 t @ ...(m)	25	30	35	40	45	50	55	60	65	70	75	80	
80	32,8	32,00	32,00	29,68	25,42	22,10	19,45	17,28	15,47	13,94	12,63	11,49	10,50	
	33,7	32,00	32,00	30,70	26,45	23,14	20,49	18,32	16,52	14,99	13,68	12,54	11,55	+
75	33,8	32,00	32,00	30,76	26,36	22,94	20,21	17,97	16,10	14,53	13,17	12,00	—	
	34,8	32,00	32,00	31,79	27,40	23,99	21,25	19,02	17,16	15,58	14,23	13,06	—	+
70	35,4	32,00	32,00	32,00	27,81	24,23	21,37	19,02	17,07	15,42	14,00	—	—	
	36,4	32,00	32,00	32,00	28,84	25,27	22,41	20,07	18,12	16,47	15,05	—	—	+
65	36,4	32,00	32,00	32,00	28,76	25,07	22,12	19,71	17,70	16,00	—	—	—	
	37,5	32,00	32,00	32,00	29,79	26,10	23,15	20,74	18,73	17,03	—	—	—	+
60	36,9	32,00	32,00	32,00	29,21	25,47	22,48	20,04	18,00	—	—	—	—	
	38,0	32,00	32,00	32,00	30,23	26,48	23,49	21,03	18,99	—	—	—	—	+
55	37,6	32,00	32,00	32,00	29,84	26,04	22,99	20,50	—	—	—	—	—	
	38,7	32,00	32,00	32,00	30,86	27,02	23,95	21,44	—	—	—	—	—	+
50	39,7	32,00	32,00	32,00	31,73	27,71	24,50	—	—	—	—	—	—	
	40,9	32,00	32,00	32,00	32,00	28,66	25,37	—	—	—	—	—	—	+
45	41,9	32,00	32,00	32,00	32,00	29,50	—	—	—	—	—	—	—	
	43,1	32,00	32,00	32,00	32,00	30,40	—	—	—	—	—	—	—	+
40	40,0	32,00	32,00	32,00	32,00	—	—	—	—	—	—	—	—	
	40,0	32,00	32,00	32,00	32,00	—	—	—	—	—	—	—	—	+
35	35,0	32,00	32,00	32,00	—	—	—	—	—	—	—	—	—	
	35,0	32,00	32,00	32,00	—	—	—	—	—	—	—	—	—	+
30	30,0	32,00	32,00	—	—	—	—	—	—	—	—	—	—	
	30,0	32,00	32,00	—	—	—	—	—	—	—	—	—	—	+
25	25,0	32,00	—	—	—	—	—	—	—	—	—	—	—	
	25,0	32,00	—	—	—	—	—	—	—	—	—	—	—	+

 ST-DR 64 t														 EXTRA Lift
	64 t @ ...(m)	25	30	35	40	45	50	55	60	65	70	75	80	
80	16,7	40,94	33,20	27,67	23,52	20,29	17,71	15,60	13,84	12,35	11,07	9,97	9,00	
	16,9	41,83	34,05	28,49	24,32	21,08	18,48	16,36	14,59	13,10	11,82	10,70	9,73	+
75	17,3	42,54	34,53	28,81	24,52	21,18	18,51	16,33	14,51	12,96	11,64	10,50	—	
	17,5	43,45	35,41	29,67	25,36	22,01	19,33	17,14	15,31	13,76	12,44	11,29	—	+
70	18,1	44,94	36,53	30,52	26,02	22,51	19,71	17,41	15,50	13,89	12,50	—	—	
	18,4	45,87	37,44	31,42	26,90	23,39	20,58	18,28	16,36	14,74	13,35	—	—	+
65	18,7	46,53	37,86	31,66	27,01	23,40	20,51	18,14	16,17	14,50	—	—	—	
	19,0	47,49	38,80	32,59	27,94	24,32	21,42	19,05	17,07	15,40	—	—	—	+
60	19,0	47,33	38,52	32,23	27,51	23,84	20,90	18,50	16,50	—	—	—	—	
	19,3	48,30	39,48	33,18	28,46	24,79	21,85	19,44	17,44	—	—	—	—	+
55	19,4	48,42	39,43	33,01	28,20	24,45	21,45	19,00	—	—	—	—	—	
	19,7	49,41	40,41	33,99	29,17	25,43	22,43	19,98	—	—	—	—	—	+
50	20,5	51,52	42,01	35,22	30,13	26,17	23,00	—	—	—	—	—	—	
	20,8	52,51	43,01	36,22	31,13	27,17	24,00	—	—	—	—	—	—	+
45	21,7	54,82	44,76	37,58	32,19	28,00	—	—	—	—	—	—	—	
	22,0	55,80	45,75	38,57	33,18	29,00	—	—	—	—	—	—	—	+
40	23,9	60,91	49,84	41,93	36,00	—	—	—	—	—	—	—	—	
	24,2	61,89	50,80	42,87	36,93	—	—	—	—	—	—	—	—	+
35	23,9	61,01	49,92	42,00	—	—	—	—	—	—	—	—	—	
	24,3	61,98	50,83	42,87	—	—	—	—	—	—	—	—	—	+
30	24,0	61,10	50,00	—	—	—	—	—	—	—	—	—	—	
	24,3	62,06	50,81	—	—	—	—	—	—	—	—	—	—	+
25	24,3	62,00	—	—	—	—	—	—	—	—	—	—	—	
	24,6	62,92	—	—	—	—	—	—	—	—	—	—	—	+

Datos válidos para / Valid data for
 Données valables pour / Gültige Daten für / Допустимые данные для / البيانات الصالحة لـ

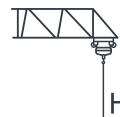

H ≤ 70 m



FEM 1005 – C25



Reservado el derecho a modificaciones sin previo aviso. Declinamos toda responsabilidad derivada de la información proporcionada / Subject to modification, without prior notice. This information is supplied without liability / L'entreprise se réserve le droit de procéder à des modifications sans préavis. Nous déclinons toute responsabilité quant aux informations fournies / Das Recht auf Änderungen ohne vorherige Ankündigung bleibt vorbehalten. Wir übernehmen keine Gewähr für die gemachten Angaben / Мы оставляем за собой право на внесение изменений без предварительного уведомления. Мы снимаем с себя любую ответственность в отношении предоставленной информации / حقوق التغيير محفوظة دون إشعار مسبق. بدون أدنى مسؤولية عن المعلومات المقدمة

CARACTERISTICAS DE MECANISMOS / MECHANISMS FEATURES

CARACTÉRISTIQUES DES MÉCANISMES / MERKMALE DER MECHANISMEN
 ХАРАКТЕРИСТИКИ МЕХАНИЗМОВ / الخصائص الآلية

J1400

EC15076VF
110 kW



*** EC18094VF**
132 kW

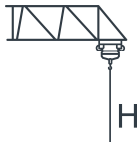
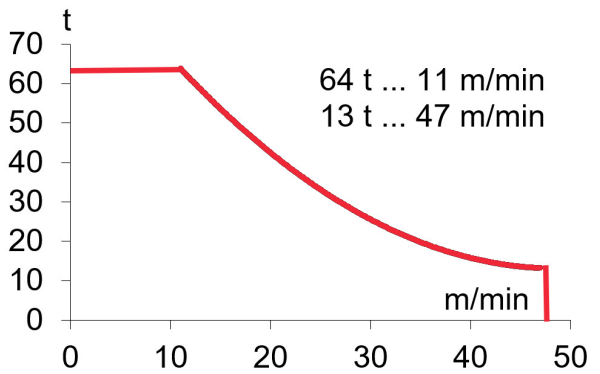
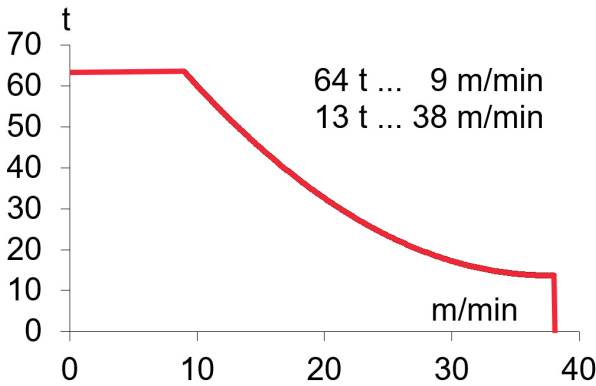
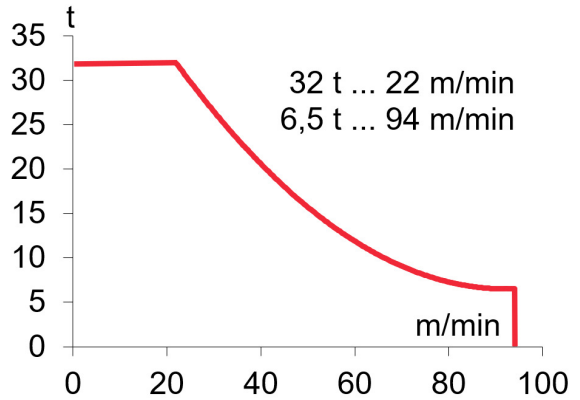
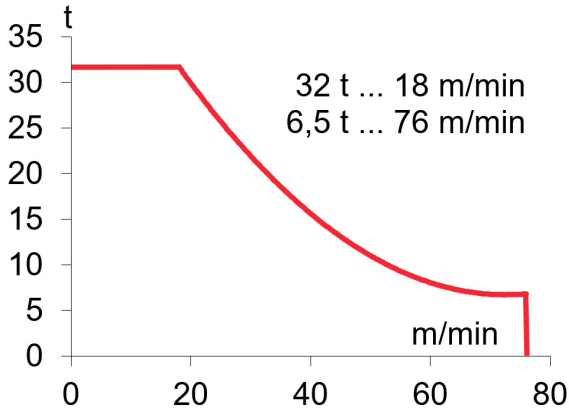

$H \leq$ SR 456 m
DR 228 m

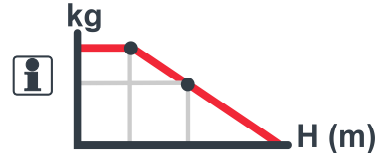

OG6007VF
3 x 15 kW

0...0,7
r/min
sl/min



TC3360VF
24,3 kW

32 t 0...60 m/min
64 t 0...30 m/min

3~ 400V 50Hz
480V 60Hz



KVA			
EC15076VF	134	161	187
EC18094VF	145	177	209



FEM 1005 – C25

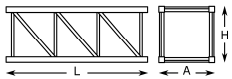
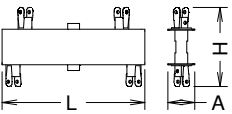
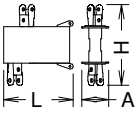
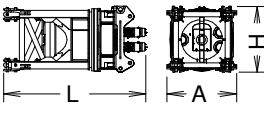
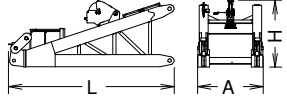

Reservado el derecho a modificaciones sin previo aviso. Declinamos toda responsabilidad derivada de la información proporcionada / Subject to modification, without prior notice. This information is supplied without liability / L'entreprise se réserve le droit de procéder à des modifications sans préavis. Nous déclinons toute responsabilité quant aux informations fournies / Das Recht auf Änderungen ohne vorherige Ankündigung bleibt vorbehalten. Wir übernehmen keine Gewähr für die gemachten Angaben / Мы оставляем за собой право на внесение изменений без предварительного уведомления. Мы снимаем с себя любую ответственность в отношении предоставленной информации / حقوق التغيير محفوظة دون إشعار مسبق. بدون أدنى مسؤولية عن المعلومات المقدمة

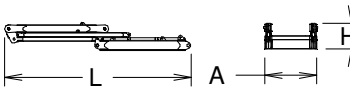
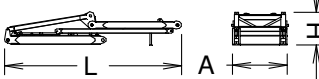
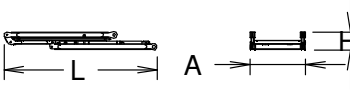
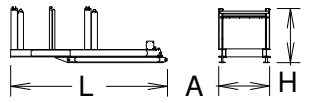
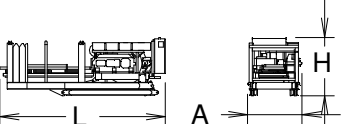
			L (m)	A (m)	H (m)	P/W (kg)
Torre / Tower Tour / Turm / Башня / برج	TSP20 TSP20-5,6 TSP24-5,6		4,374 6,164 6,164	2,285 2,285 2,754	2,383 2,383 2,852	5615 7665 8295
Larguero largo, reducción Long crossbar, reduction Traverse longue, réduction Langer Längsträger, Reduzierung Длинная продольная балка, عارضضة طويلة، مُصغر	TSP24/TSP20		3,924	0,73	2,22	3823
Larguero corto reducción / Short crossbar, reduction, Traverse courte, réduction / Kurzer Längsträger, Reduzierung / Короткая продольная балка, уменьшение / عارضضة قصيرة، مُصغر	TSP24/TSP20		1,902	0,73	2,22	1870
Torre asiento pista + base punta de torre + orientación Slewing table + tower head base + slewing mechanism Tour pivot + base du porte-flèche + mécanisme d'orientation Turmsitz + Turmspitzenbasis + Ausrichtung Сиденье площадки + основание верхней секции башни + поворотный механизм برج وحدة الدوارن + قاعدة رأس البرج + آلية الدوران			5,180	2,445	2,545	21600
Punta de torre / Tower head Porte-flèche / Turmspitze верхняя секция башни / رأس البرج			5,571	2,215	2,229	7260
Tramo de pluma Jib section Tronçon de flèche Auslegerabschnitt Секция стрелы أجزاء الذراع	PC22-11 PC22-12+tr PC22-13 PC22-14 PC22-15 PPC22 PT22-16 PT22-17 PT22-18 PT22-19 PPT22		10,870 10,320 5,380 10,380 10,385 1,225 10,370 10,345 10,345 5,345 1,225	2,325 2,125 2,075 2,150 2,075 2,335 2,075 2,075 2,075 2,075 2,335	2,650 2,495 2,500 2,500 2,500 2,940 2,475 2,475 2,475 2,475 2,940	9030 12200 5640 9660 8200 850 4225 3330 2445 1410 800
Contrapluma / Counterjib Contre-flèche / Gegenausleger Противовесная консоль / الذراع المعاكس	CC18-1		7,490	2,170	1,125	5455
Contrapluma / Counterjib Contre-flèche / Gegenausleger Противовесная консоль / الذراع المعاكس	CC18-2		6,770	2,170	1,280	4995
Contrapluma / Counterjib Contre-flèche / Gegenausleger Противовесная консоль / الذراع المعاكس	CC18-3		5,470	2,100	0,660	2310
Contrapluma / Counterjib Contre-flèche / Gegenausleger Противовесная консоль / الذراع المعاكس	CC18-4		6,590	2,195	2,260	4850
Contrapluma + Mec. Elevación Counterjib + Hoisting Mech. Contre-flèche + Mech. De Levage Gegenausleger + Lasthubmechanismus	CC18-4 + EC		6,955	2,329	2,445	12975

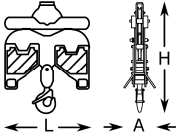
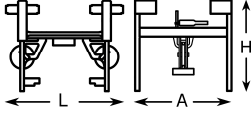
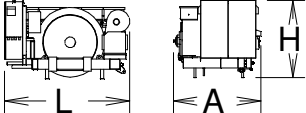
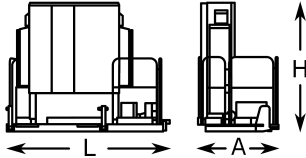
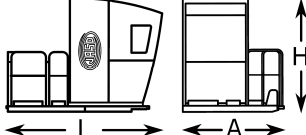
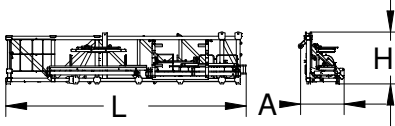
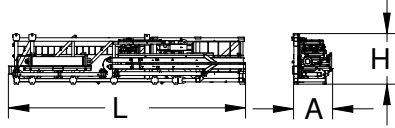
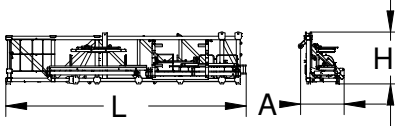
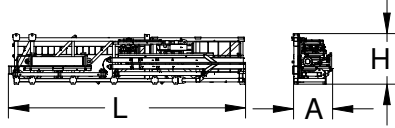
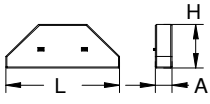
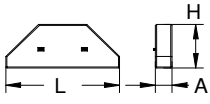
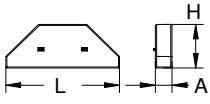

		L (m)	A (m)	H (m)	P/W(kg)	
Polipasto / Hook assembly Palan / Flaschenzug Полиспаст / بكرة	SR ST/DR				1,635	1325
		2,315	0,360	1,735	2920	
Carro / Trolley Chariot / Laufkatze Грузовая тележка / عرب	SR ST/DR				3,050	1570
		3,685	2,875	2,390	2580	
Soporte y elevación (sin cable) Support and hoisting (without rope) Support et levage (sans câble) Опора и подъем (без троса) Abstützung und Hebewerk (ohne Seil) دعم ورفع (بدون كابل)					3,185	8125
		2,320	2,005	8125		
Armario eléctrico y plataforma Electrical cabinet and platform Armoire électrique et plateforme Stromkasten + Plattform الخزانة الكهربائية والمنصة					2,710	950
		1,585	2,375	950		
Plataforma y cabina / Platform and cabin Plateforme et cabine / Plattform + Führerstand منصة وكابينة /					3,670	1110
		2,215	2,480	1110		
Transporte torre de montaje Jacking cage transport Transport de tour de montage Transport Montageturm Транспортировка монтажной башни نقل برج التركيب		TM20PASP-5.6 Package 1. 			11,610	11915
		Package 2. 			11,670	14430
					2,220	2,485
					2,010	2,485
Contrapeso / Counterweight Contrepoids / Gegengewicht Противовес /	Lastre / Ballast Lest / Ballast Балласт /				3,800	6000
					3,800	3000
					3,800	2000



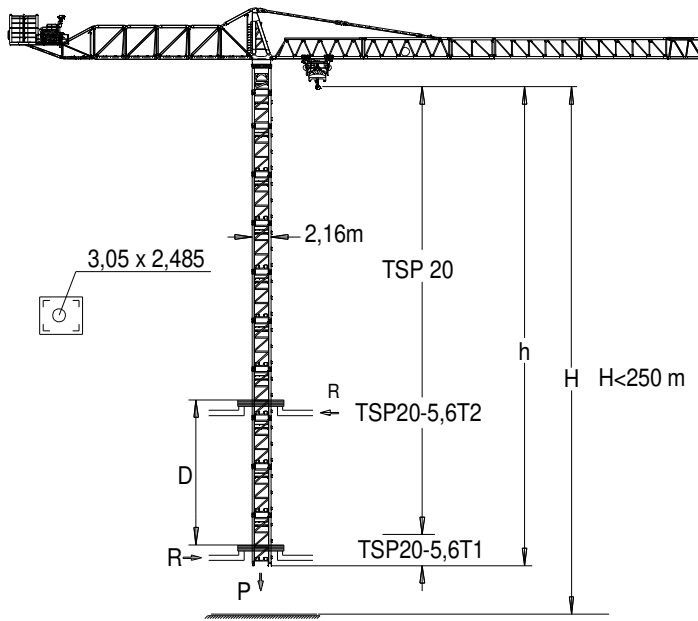

h_{max} :
TSP20-5,6T1 + 7xTSP20-5,6 + TSP20-5,6T2 + TSP20

	▶	■
h (m)	54,7	
D (m)	12,6 – 25,8	
P (KN)	3765	3125
R _{max} (KN)	760	1500

h_{max} :
TSP20-5,6T1 + 6xTSP20-5,6 + TSP20-5,6T2

	▶	■
h (m)	45,3	
D (m)	11,8 – 21,1	
P (KN)	3395	2755
R _{max} (KN)	900	1475

TSP20-5,6T1: 214.31.400
TSP20-5,6T2: 214.31.600



Trepado interno / Internal climbing / TéléscoPAGE / Inneres klettersystem / Внутренняя лестница / التسلق الداخلي

 **Viento fuera de servicio / Out of service wind / Vitesse du vent hors service / Wind außer betrieb / Ветровая нагрузка в покое / الريح خارج الخدمة**

 **Consultar / Consult / Nous consulter / Anfragen / Консультируйтесь / الرجوع إلى**

 **En servicio / In service / En service / In betrieb / В работе / في الخدمة**

 **Fuera de servicio / Out of service / Hors service / Außer betrieb / В покое / خارج الخدمة**

 **Opcional / Optional / En option / Optional / Опция / اختياري**



Ctra./ Rd. Madrid – Irún - Km. 415 - 20213 IDIAZABAL (Gipuzkoa) - ESPAÑA / SPAIN
P.O. Box, 23 - 20.200 - BEASAIN - E-mail: jaso@jaso.com
Tel. +34 943 - 18 70 00 • Fax. +34 943 - 18 70 20
www.jaso.com

29/11/2024



FEM 1005 – C25

DELEGACIÓN / DEALER

Reservado el derecho a modificaciones sin previo aviso. Declinamos toda responsabilidad derivada de la información proporcionada / Subject to modification, without prior notice. This information is supplied without liability / L'entreprise se réserve le droit de procéder à des modifications sans préavis. Nous déclinons toute responsabilité quant aux informations fournies / Das Recht auf Änderungen ohne vorherige Ankündigung bleibt vorbehalten. Wir übernehmen keine Gewähr für die gemachten Angaben / Мы оставляем за собой право на внесение изменений без предварительного уведомления. Мы снимаем с себя любую ответственность в отношении предоставленной информации / حقوق التغيير محفوظة دون إشعار مسبق. دون أدنى مسؤولية عن المعلومات المقدمة