



EN 14439  
C25

# J1400

**GRUA TORRE / TOWER CRANE**  
GRUE A TOUR / TURMDREHKRAN / БАШЕННЫЙ КРАН / رافعة برجية

FEM 1005 - C25

UNE-EN-ISO 9001

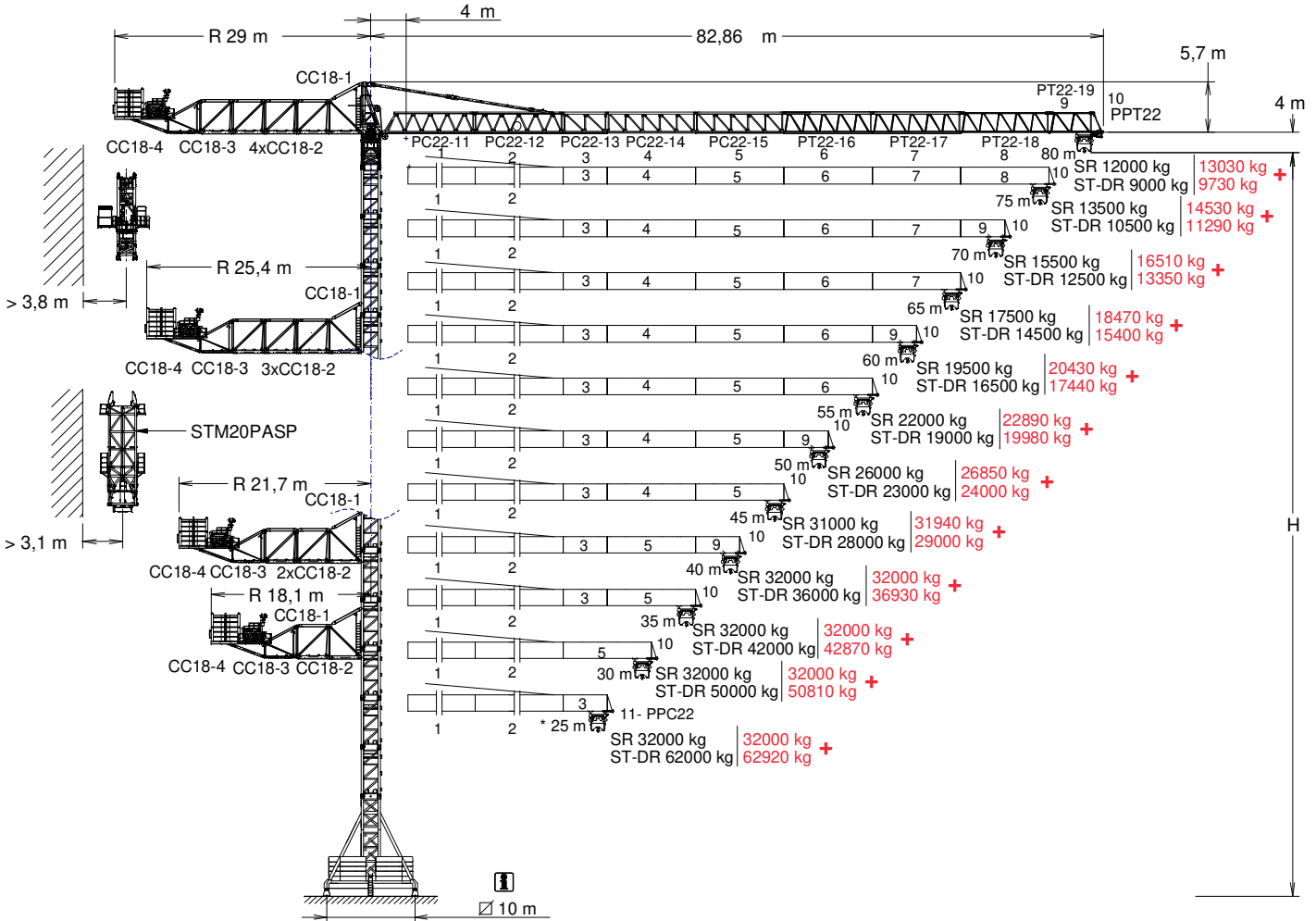

**\*OPTIONAL EXTRA LIFT**

H= **Altura máxima bajo gancho sin arriostrar (m) / Maximum height under hook without fastening (m) / Hauteur maximale sous crochet sans ancrage (m).**  
Max. Hakenhöhe ohne Verstreben (m) / Максимальная высота под крюком без крепления (m) / (م) أقصى ارتفاع تحت الخطاف بدون ربط

PC22-11.....	169.40.000	PC22-15.....	169.44.000	PT22-19.....	169.48.000	TSP20.....	214.31.300
PC22-12.....	169.41.000	PT22-16.....	169.45.000	PPT22.....	169.48.200	TSP20-5,6.....	214.31.100
PC22-13.....	169.42.000	PT22-17.....	169.46.000	PPC22.....	169.48.400	TSP24-5,6.....	214.32.200
PC22-14.....	169.43.000	PT22-18.....	169.47.000			TSP24/TSP20.....	212.36.000

## CUSTOMIZE YOUR CRANE

**OPTIMUS**  
line

EXTRA Lift	OPTI Cube	TC Diagnosis SYSTEM	CLIMBING Solution	SAFETY Pack	Customization	ECO Mode	COMFORT Cabin	HIGH POWER Motors	JL25 Tower Crane Elevator	SMARTLINK BE SMART keep control



Reservado el derecho a modificaciones sin previo aviso. Declinamos toda responsabilidad derivada de la información proporcionada / Subject to modification, without prior notice. This information is supplied without liability / L'entreprise se réserve le droit de procéder à des modifications sans préavis. Nous déclinons toute responsabilité quant aux informations fournies / Das Recht auf Änderungen ohne vorherige Ankündigung bleibt vorbehalten. Wir übernehmen keine Gewähr für die gemachten Angaben / Мы оставляем за собой право на внесение изменений без предварительного уведомления. Мы снимаем с себя любую ответственность в отношении предоставленной информации / حقوق التغيير محفوظة دون إشعار مسبق. بدون أدنى مسؤولية عن المعلومات المقدمة

16/04/2025

(H) ESTACIONARIA 1 / STATIONARY 1 / STATIONAIRE 1 / STATIONÄR 1 / СТАЦИОНАРНОЕ СОСТОЯНИЕ / ثابتة

SR

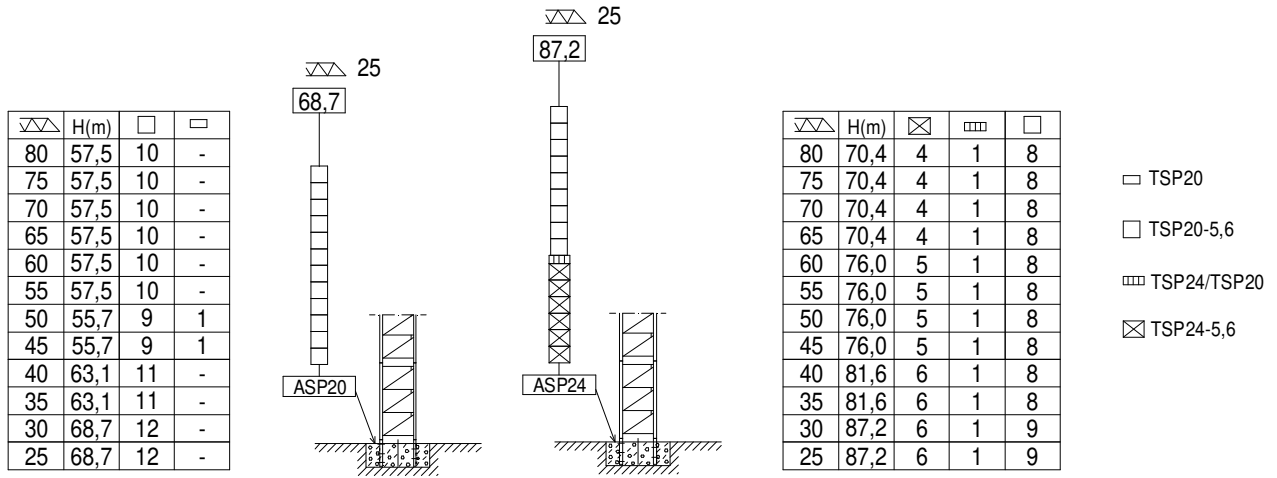

ST-SR / ST-DR

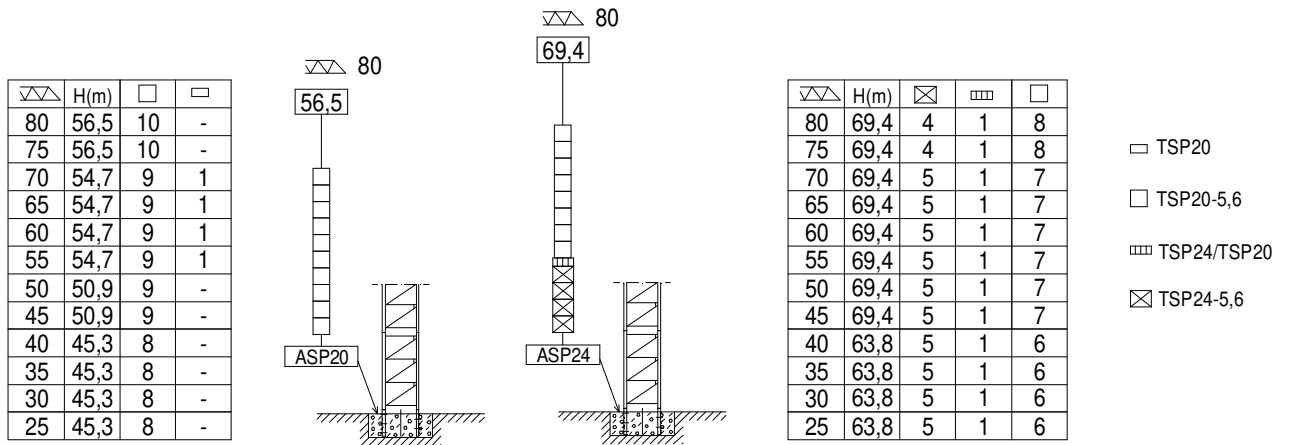

ASP20 ..... 212.21.200

ASP24..... 212.21.500



SR - 32 t

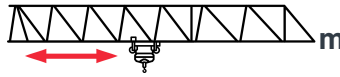

EXTRA Lift

	32 t @ ...(m)	25	30	35	40	45	50	55	60	65	70	75	80	
80	34,2	32,00	32,00	31,22	26,95	23,63	20,97	18,80	16,98	15,45	14,14	13,00	12,00	+
	35,2	32,00	32,00	32,00	27,94	24,63	21,98	19,81	18,00	16,47	15,16	14,02	13,03	
75	35,3	32,00	32,00	32,00	27,89	24,47	21,73	19,48	17,61	16,03	14,68	13,50	—	+
	36,3	32,00	32,00	32,00	28,89	25,47	22,73	20,49	18,63	17,05	15,70	14,53	—	
70	37,0	32,00	32,00	32,00	29,34	25,75	22,88	20,53	18,58	16,92	15,50	—	—	+
	38,0	32,00	32,00	32,00	30,33	26,74	23,88	21,53	19,58	17,92	16,51	—	—	
65	38,0	32,00	32,00	32,00	30,28	26,59	23,64	21,22	19,20	17,50	—	—	—	+
	39,1	32,00	32,00	32,00	31,27	27,57	24,61	22,20	20,18	18,47	—	—	—	
60	38,5	32,00	32,00	32,00	30,73	26,98	23,99	21,54	19,50	—	—	—	—	+
	39,7	32,00	32,00	32,00	31,71	27,95	24,94	22,48	20,43	—	—	—	—	
55	39,3	32,00	32,00	32,00	31,36	27,54	24,50	22,00	—	—	—	—	—	+
	40,4	32,00	32,00	32,00	32,00	28,49	25,41	22,89	—	—	—	—	—	
50	41,4	32,00	32,00	32,00	32,00	29,22	26,00	—	—	—	—	—	—	+
	42,6	32,00	32,00	32,00	32,00	30,15	26,85	—	—	—	—	—	—	
45	43,7	32,00	32,00	32,00	32,00	31,00	—	—	—	—	—	—	—	+
	45,0	32,00	32,00	32,00	32,00	31,94	—	—	—	—	—	—	—	
40	40,0	32,00	32,00	32,00	32,00	—	—	—	—	—	—	—	—	+
	40,0	32,00	32,00	32,00	32,00	—	—	—	—	—	—	—	—	
35	35,0	32,00	32,00	32,00	—	—	—	—	—	—	—	—	—	+
	35,0	32,00	32,00	32,00	—	—	—	—	—	—	—	—	—	
30	30,0	32,00	32,00	—	—	—	—	—	—	—	—	—	—	+
	30,0	32,00	32,00	—	—	—	—	—	—	—	—	—	—	
25	25,0	32,00	—	—	—	—	—	—	—	—	—	—	—	+
	25,0	32,00	—	—	—	—	—	—	—	—	—	—	—	

Datos válidos para / Valid data for

Donnees valables pour / Gultige Daten für / Допустимые данные для / البيانات الصالحة لـ



H ≤ 70 m

ST-SR 32 t														
32 t @ ...(m)	25	30	35	40	45	50	55	60	65	70	75	80	EXTRA Lift	
80	32,8 33,7	32,00 32,00	32,00 32,00	29,68 30,70	25,42 26,45	22,10 23,14	19,45 20,49	17,28 18,32	15,47 16,52	13,94 14,99	12,63 13,68	11,49 12,54	10,50 11,55	+
75	33,8 34,8	32,00 32,00	32,00 32,00	30,76 31,79	26,36 27,40	22,94 23,99	20,21 21,25	17,97 19,02	16,10 17,16	14,53 15,58	13,17 14,23	12,00 13,06	—	+
70	35,4 36,4	32,00 32,00	32,00 32,00	32,00 32,00	27,81 28,84	24,23 25,27	21,37 22,41	19,02 20,07	17,07 18,12	15,42 16,47	14,00 15,05	—	—	+
65	36,4 37,5	32,00 32,00	32,00 32,00	32,00 32,00	28,76 29,79	25,07 26,10	22,12 23,15	19,71 20,74	17,70 18,73	16,00 17,03	—	—	—	+
60	36,9 38,0	32,00 32,00	32,00 32,00	32,00 32,00	29,21 30,23	25,47 26,48	22,48 23,49	20,04 21,03	18,00 18,99	—	—	—	—	+
55	37,6 38,7	32,00 32,00	32,00 32,00	32,00 32,00	29,84 30,86	26,04 27,02	22,99 23,95	20,50 21,44	—	—	—	—	—	+
50	39,7 40,9	32,00 32,00	32,00 32,00	32,00 32,00	31,73 32,00	27,71 28,66	24,50 25,37	—	—	—	—	—	—	+
45	41,9 43,1	32,00 32,00	32,00 32,00	32,00 32,00	32,00 30,40	29,50 30,40	—	—	—	—	—	—	—	+
40	40,0 40,0	32,00 32,00	32,00 32,00	32,00 32,00	32,00 —	—	—	—	—	—	—	—	—	+
35	35,0 35,0	32,00 32,00	32,00 32,00	32,00 —	—	—	—	—	—	—	—	—	—	+
30	30,0 30,0	32,00 32,00	32,00 —	—	—	—	—	—	—	—	—	—	—	+
25	25,0 25,0	32,00 —	—	—	—	—	—	—	—	—	—	—	—	+

ST-DR 64 t														
64 t @ ...(m)	25	30	35	40	45	50	55	60	65	70	75	80	EXTRA Lift	
80	16,7 16,9	40,94 41,83	33,20 34,05	27,67 28,49	23,52 24,32	20,29 21,08	17,71 18,48	15,60 16,36	13,84 14,59	12,35 13,10	11,07 11,82	9,97 10,70	9,00 9,73	+
75	17,3 17,5	42,54 43,45	34,53 35,41	28,81 29,67	24,52 25,36	21,18 22,01	18,51 19,33	16,33 17,14	14,51 15,31	12,96 13,76	11,64 12,44	10,50 11,29	—	+
70	18,1 18,4	44,94 45,87	36,53 37,44	30,52 31,42	26,02 26,90	22,51 23,39	19,71 20,58	17,41 18,28	15,50 16,36	13,89 14,74	12,50 13,35	—	—	+
65	18,7 19,0	46,53 47,49	37,86 38,80	31,66 32,59	27,01 27,94	23,40 24,32	20,51 21,42	18,14 19,05	16,17 17,07	14,50 15,40	—	—	—	+
60	19,0 19,3	47,33 48,30	38,52 39,48	32,23 33,18	27,51 28,46	23,84 24,79	20,90 21,85	18,50 19,44	16,50 17,44	—	—	—	—	+
55	19,4 19,7	48,42 49,41	39,43 40,41	33,01 33,99	28,20 29,17	24,45 25,43	21,45 22,43	19,00 19,98	—	—	—	—	—	+
50	20,5 20,8	51,52 52,51	42,01 43,01	35,22 36,22	30,13 31,13	26,17 27,17	23,00 24,00	—	—	—	—	—	—	+
45	21,7 22,0	54,82 55,80	44,76 45,75	37,58 38,57	32,19 33,18	28,00 29,00	—	—	—	—	—	—	—	+
40	23,9 24,2	60,91 61,89	49,84 50,80	41,93 42,87	36,00 36,93	—	—	—	—	—	—	—	—	+
35	23,9 24,3	61,01 61,98	49,92 50,83	42,00 42,87	—	—	—	—	—	—	—	—	—	+
30	24,0 24,3	61,10 62,06	50,00 50,81	—	—	—	—	—	—	—	—	—	—	+
25	24,3 24,6	62,00 62,92	—	—	—	—	—	—	—	—	—	—	—	+

Datos válidos para / Valid data for  
Donnees valables pour / Gultige Daten für / Допустимые данные для / البيانات الصالحة لـ

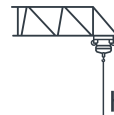

H ≤ 70 m



FEM 1005 – C25



Reservado el derecho a modificaciones sin previo aviso. Declinamos toda responsabilidad derivada de la información proporcionada / Subject to modification, without prior notice. This information is supplied without liability / L'entreprise se réserve le droit de procéder à des modifications sans préavis. Nous déclinons toute responsabilité quant aux informations fournies / Das Recht auf Änderungen ohne vorherige Ankündigung bleibt vorbehalten. Wir übernehmen keine Gewähr für die gemachten Angaben / Мы оставляем за собой право на внесение изменений без предварительного уведомления. Мы снимаем с себя любую ответственность в отношении предоставленной информации / حقوق التغيير محفوظة دون إشعار مسبق. بدون أدنى مسؤولية عن المعلومات المقدمة /

**CARACTERISTICAS DE MECANISMOS / MECHANISMS FEATURES**

CARACTÉRISTIQUES DES MÉCANISMES / MERKMALE DER MECHANISMEN  
 ХАРАКТЕРИСТИКИ МЕХАНИЗМОВ / الخصائص الآلية

**J1400**

**EC15076VF**  
110 kW



**\* EC18094VF**  
132 kW

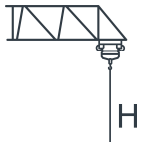
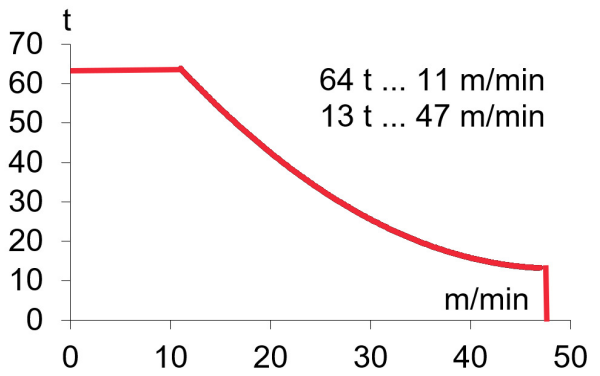
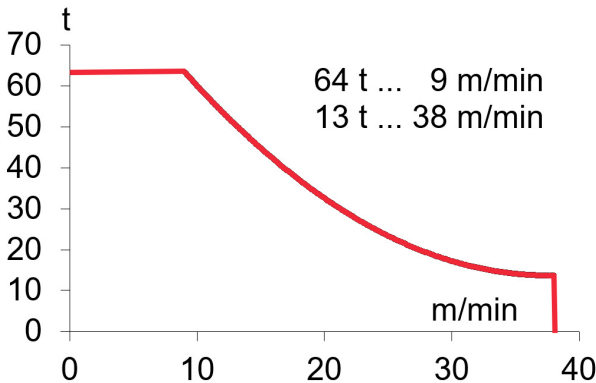
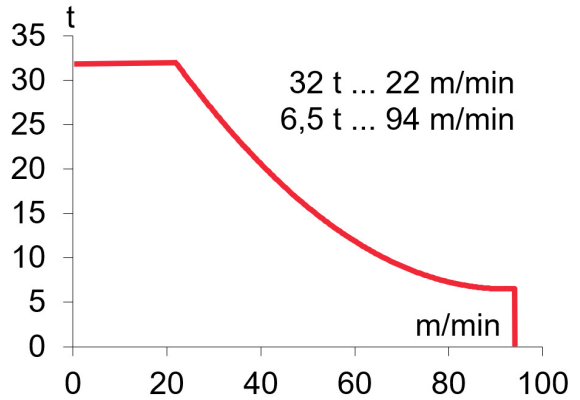
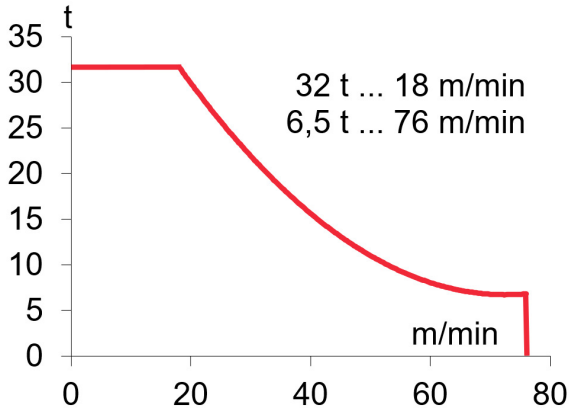

$H \leq$  SR 456 m  
DR 228 m

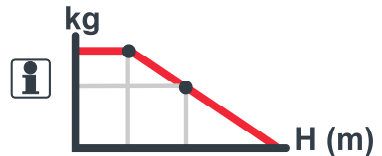

**OG6007VF**  
3 x 15 kW

0...0,7  
r/min  
sl/min



**TC3360VF**  
24,3 kW

32 t 0...60 m/min  
64 t 0...30 m/min

3~ 400V 50Hz  
480V 60Hz



KVA			
<b>EC15076VF</b>	134	161	187
<b>EC18094VF</b>	145	177	209



**FEM 1005 – C25**

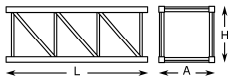
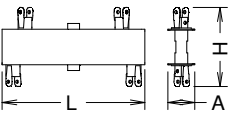
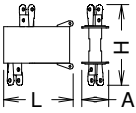
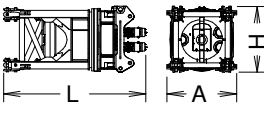
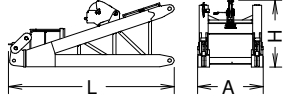

Reservado el derecho a modificaciones sin previo aviso. Declinamos toda responsabilidad derivada de la información proporcionada / Subject to modification, without prior notice. This information is supplied without liability / L'entreprise se réserve le droit de procéder à des modifications sans préavis. Nous déclinons toute responsabilité quant aux informations fournies / Das Recht auf Änderungen ohne vorherige Ankündigung bleibt vorbehalten. Wir übernehmen keine Gewähr für die gemachten Angaben / Мы оставляем за собой право на внесение изменений без предварительного уведомления. Мы снимаем с себя любую ответственность в отношении предоставленной информации / حقوق التغيير محفوظة دون إشعار مسبق. بدون أدنى مسؤولية عن المعلومات المقدمة /

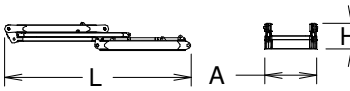
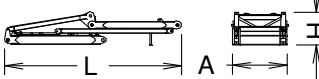
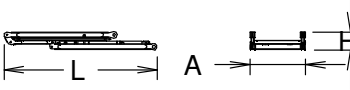
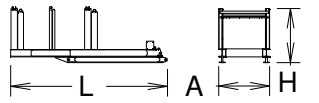
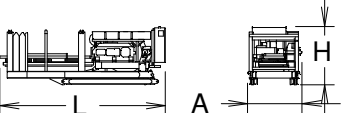
			L (m)	A (m)	H (m)	P/W (kg)
<b>Torre / Tower</b> Tour / Turm / Башня / برج	TSP20 TSP20-5,6 TSP24-5,6		4,374 6,164 6,164	2,285 2,285 2,754	2,383 2,383 2,852	5615 7665 8295
<b>Larguero largo, reducción</b> <b>Long crossbar, reduction</b> Traverse longue, réduction Langer Längsträger, Reduzierung Длинная продольная балка, عارضضة طويلة، مُصغر	TSP24/TSP20		3,924	0,73	2,22	3823
<b>Larguero corto reducción / Short crossbar, reduction,</b> Traverse courte, réduction / Kurzer Längsträger, Reduzierung / Короткая продольная балка, уменьшение / عارضضة قصيرة، مُصغر	TSP24/TSP20		1,902	0,73	2,22	1870
<b>Torre asiento pista + base punta de torre + orientación</b> <b>Slewing table + tower head base + slewing mechanism</b> Tour pivot + base du porte-flèche + mécanisme d'orientation Turmsitz + Turmspitzenbasis + Ausrichtung Сиденье площадки + основание верхней секции башни + поворотный механизм برج وحدة الدوارن + قاعدة رأس البرج + آلية الدوران			5,180	2,445	2,545	21600
<b>Punta de torre / Tower head</b> Porte-flèche / Turmspitze верхняя секция башни / رأس البرج			5,571	2,215	2,229	7260
<b>Tramo de pluma</b> <b>Jib section</b> Tronçon de flèche Auslegerabschnitt Секция стрелы أجزاء الذراع	PC22-11 PC22-12+tr PC22-13 PC22-14 PC22-15 PPC22 PT22-16 PT22-17 PT22-18 PT22-19 PPT22		10,870 10,320 5,380 10,380 10,385 1,225 10,370 10,345 10,345 5,345 1,225	2,325 2,125 2,075 2,150 2,075 2,335 2,075 2,075 2,075 2,075 2,335	2,650 2,495 2,500 2,500 2,500 2,940 2,475 2,475 2,475 2,475 2,940	9030 12200 5640 9660 8200 850 4225 3330 2445 1410 800
<b>Contrapluma / Counterjib</b> Contre-flèche / Gegenausleger Противовесная консоль / الذراع المعاكس	CC18-1		7,490	2,170	1,125	5455
<b>Contrapluma / Counterjib</b> Contre-flèche / Gegenausleger Противовесная консоль / الذراع المعاكس	CC18-2		6,770	2,170	1,280	4995
<b>Contrapluma / Counterjib</b> Contre-flèche / Gegenausleger Противовесная консоль / الذراع المعاكس	CC18-3		5,470	2,100	0,660	2310
<b>Contrapluma / Counterjib</b> Contre-flèche / Gegenausleger Противовесная консоль / الذراع المعاكس	CC18-4		6,590	2,195	2,260	4850
<b>Contrapluma + Mec. Elevación</b> <b>Counterjib + Hoisting Mech.</b> Contre-flèche + Mech. De Levage Gegenausleger + Lasthubmechanismus	CC18-4 + EC		6,955	2,329	2,445	12975

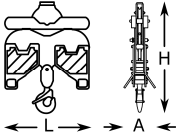
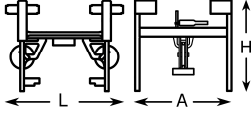
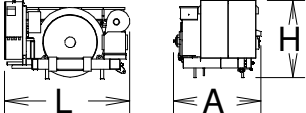
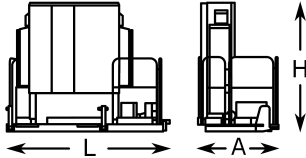
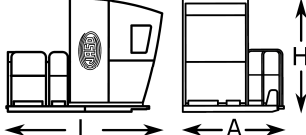
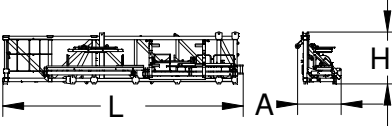
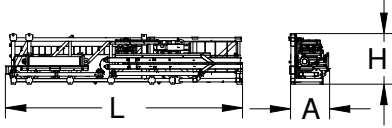
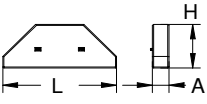

		L (m)	A (m)	H (m)	P/W(kg)	
<b>Polipasto / Hook assembly</b> Palan / Flaschenzug Полиспаст / بكرة	SR ST/DR		1,635	0,360	1,735	1325
			2,315	0,920	3,345	2920
<b>Carro / Trolley</b> Chariot / Laufkatze Грузовая тележка / عرب	SR ST/DR		3,050	2,875	2,390	1570
			3,685	2,420	2,330	2580
<b>Soporte y elevación (sin cable)</b> <b>Support and hoisting (without rope)</b> Support et levage (sans câble) Опора и подъем (без троса) Abstützung und Hebewerk (ohne Seil) دعم ورفع (بدون كابل)			3,185	2,320	2,005	8125
<b>Armario eléctrico y plataforma</b> <b>Electrical cabinet and platform</b> Armoire électrique et plateforme Stromkasten + Plattform الخزانة الكهربائية والمنصة			2,710	1,585	2,375	950
<b>Plataforma y cabina / Platform and cabin</b> Plateforme et cabine / Plattform + Führerstand Платформа и кабина / منصة وكابينة			3,670	2,215	2,480	1110
<b>Transporte torre de montaje</b> <b>Jacking cage transport</b> Transport de tour de montage Transport Montageturm Транспортировка монтажной башни نقل برج التركيب		<b>TM20PASP-5.6</b> Package 1. 	11,610	2,220	2,485	11915
			<b>Package 2.</b> 	11,670	2,010	2,485
<b>Contrapeso / Counterweight</b> Contrepoids / Gegengewicht Противовес / اوزان معاكسة	<b>Lastre / Ballast</b> Lest / Ballast باللاست / ثقل ثقيل		3,800	0,580	1,500	6000
			3,800	0,275	1,500	3000
			3,800	0,180	1,500	2000





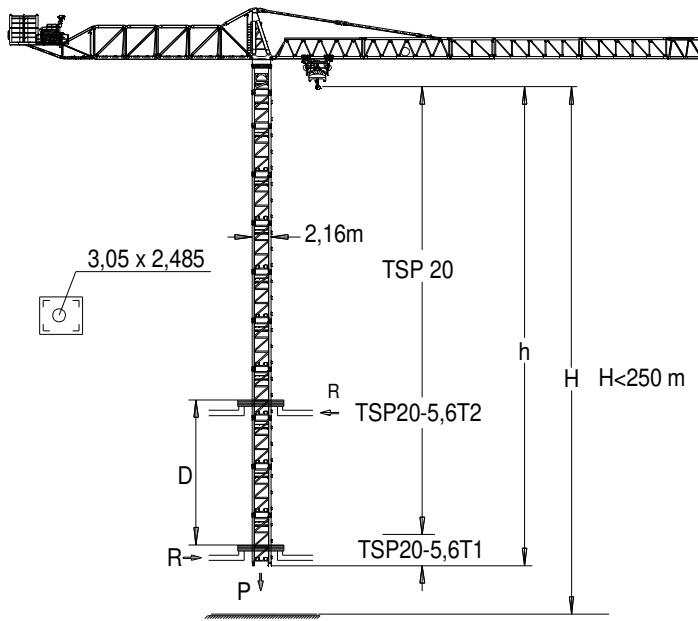

$h_{max}$ :  
TSP20-5,6T1 + 7xTSP20-5,6 + TSP20-5,6T2 + TSP20

	▶	■
h (m)	54,7	
D (m)	12,6 – 25,8	
P (KN)	3765	3125
R <sub>max</sub> (KN)	760	1500

$h_{max}$ :  
TSP20-5,6T1 + 6xTSP20-5,6 + TSP20-5,6T2

	▶	■
h (m)	45,3	
D (m)	11,8 – 21,1	
P (KN)	3395	2755
R <sub>max</sub> (KN)	900	1475

TSP20-5,6T1: 214.31.400  
TSP20-5,6T2: 214.31.600



Trepado interno / Internal climbing / TéléscoPAGE / Inneres klettersystem / Внутренняя лестница / التسلق الداخلي

 Viento fuera de servicio / Out of service wind / Vitesse du vent hors service / Wind außer betrieb / Ветровая нагрузка в покое / الريح خارج الخدمة

 Consultar / Consult / Nous consulter / Anfragen / Консультируйтесь / الرجوع إلى

▶ En servicio / In service / En service / In betrieb / В работе / في الخدمة

■ Fuera de servicio / Out of service / Hors service / Außer betrieb / В покое / خارج الخدمة

\* Opcional / Optional / En option / Optional / Опция / اختياري



Ctra./ Rd. Madrid – Irún - Km. 415 - 20213 IDIAZABAL (Gipuzkoa) - ESPAÑA / SPAIN  
P.O. Box, 23 - 20.200 - BEASAIN - E-mail: jaso@jaso.com  
Tel. +34 943 - 18 70 00 • Fax. +34 943 - 18 70 20  
[www.jaso.com](http://www.jaso.com)

16/04/2025



FEM 1005 – C25

DELEGACIÓN / DEALER

Reservado el derecho a modificaciones sin previo aviso. Declinamos toda responsabilidad derivada de la información proporcionada / Subject to modification, without prior notice. This information is supplied without liability / L'entreprise se réserve le droit de procéder à des modifications sans préavis. Nous déclinons toute responsabilité quant aux informations fournies / Das Recht auf Änderungen ohne vorherige Ankündigung bleibt vorbehalten. Wir übernehmen keine Gewähr für die gemachten Angaben / Мы оставляем за собой право на внесение изменений без предварительного уведомления. Мы снимаем с себя любую ответственность в отношении предоставленной информации / حقوق التغيير محفوظة دون إشعار مسبق. دون أدنى مسؤولية عن المعلومات المقدمة