



EN 14439
C25

J638PA

GRUA TORRE / TOWER CRANE

FEM 1005 - C25

UNE-EN-ISO 9001

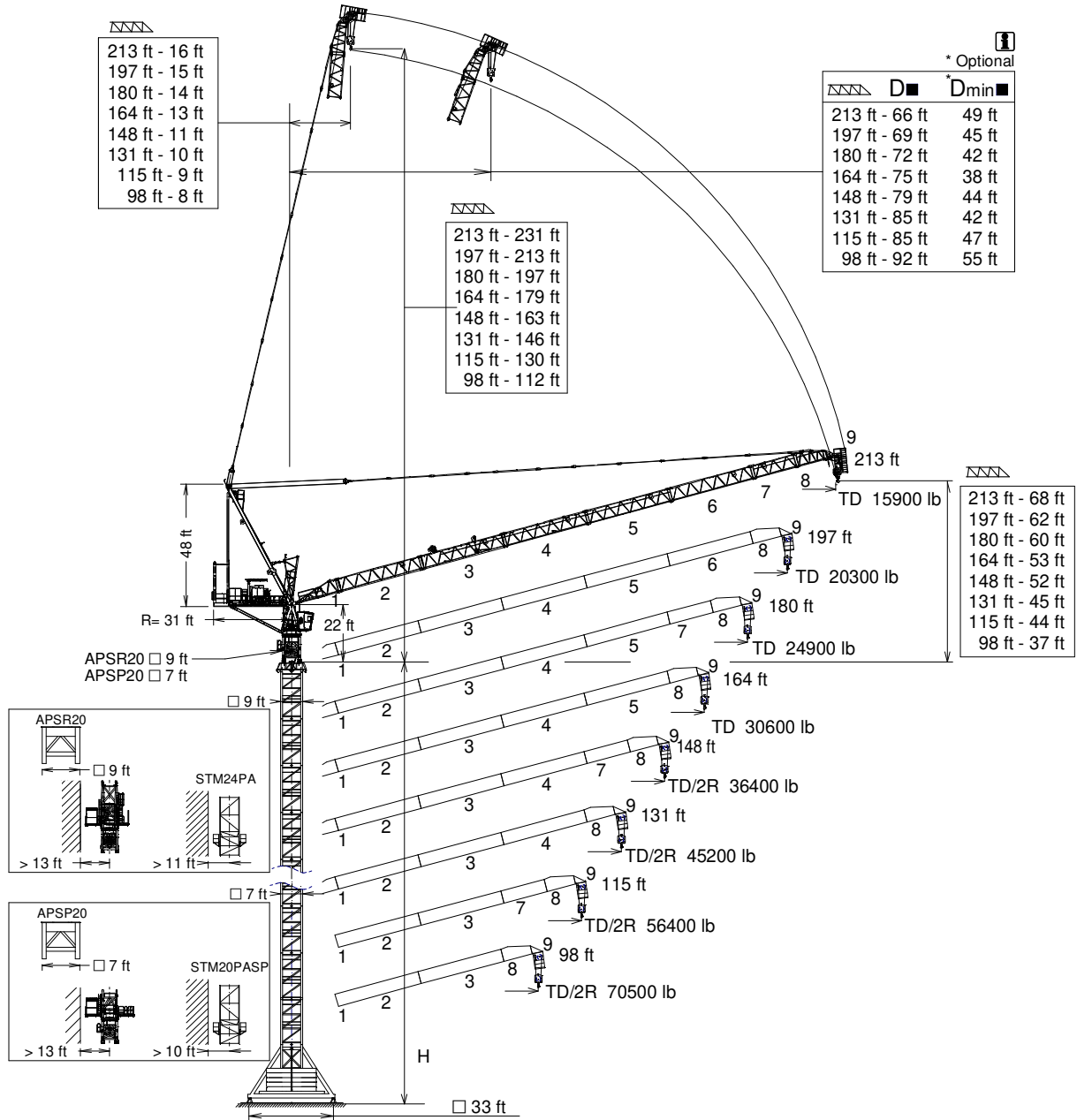

H= Máxima altura de torre sin arriostrar (ft) / Maximum tower height without fastening (ft)

D ■ Distancias fuera de servicio dependen de la altura de la torre / Out of service distances depend on tower height

*Dmin ■ Distancias mínimas fuera de servicio dependen de la altura de la torre / Out of service minimum distances depend on tower height

Tramo pluma 1 / Jib section 1216.40.000	Tramo pluma 6 / Jib section 6216.45.000	TR24-5,6 206.32.000	TSP20214.31.300
Tramo pluma 2 / Jib section 2216.41.000	Tramo pluma 7 / Jib section 7216.46.000	TRD24-5,6 206.32.300	TSP20-5,6214.31.100
Tramo pluma 3 / Jib section 3216.42.000	Tramo pluma 8 / Jib section 8206.47.200	TRID24-5,6 156.30.800	
Tramo pluma 4 / Jib section 4216.43.000	Tramo pluma 9 / Jib section 9212.48.000	TR24/TSR20 204.36.500	
Tramo pluma 5 / Jib section 5216.44.000			

CUSTOMIZE YOUR CRANE

OPTIMUS
line JASD



OPTI Cube



TC Diagnosis SYSTEM



CLIMBING Solution



SAFETY Pack



Customization



ECO Mode



COMFORT Cabin



HIGH POWER Motors



JL25 Tower Crane Elevator



BE SMART keep control



Reservado el derecho a modificaciones sin previo aviso. Declinamos toda responsabilidad derivada de la información proporcionada / Subject to modification, without prior notice. This information is supplied without liability

07/05/2026

*Dmin ■

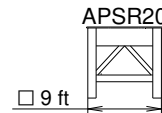

(H) ESTACIONARIA / STATIONARY

TD

▽▽	H(ft)	D■(ft)	⊠	≡
213	152	66	8	1
197	152	69	8	1
180	171	72	9	1
164	171	75	9	1
148	189	79	10	1
131	189	82	10	1
115	189	79	10	1
98	207	82	11	1

TD / 2R

▽▽	H(ft)	D■(ft)	⊠	≡
213	152	66	8	1
197	152	69	8	1
180	152	72	8	1
164	152	75	8	1
148	152	79	8	1
131	152	85	8	1
115	152	85	8	1
98	152	92	8	1

(H) ESTACIONARIA 3 / STATIONARY 3

TD

▽▽	H(ft)	D■(ft)	⊠	≡
213	174	66	8	1
197	174	69	8	1
180	193	72	9	1
164	193	75	9	1
148	211	79	10	1
131	211	82	10	1
115	211	79	10	1
98	211	82	10	1

TD / 2R

▽▽	H(ft)	D■(ft)	⊠	≡
213	174	66	8	1
197	174	69	8	1
180	174	72	8	1
164	174	75	8	1
148	174	79	8	1
131	174	85	8	1
115	174	85	8	1
98	174	92	8	1

(H) TRASLACION / TRAVELLING

TD

▽▽	H(ft)	D■(ft)	⊠	≡
213	177	66	8	1
197	177	69	8	1
180	195	72	9	1
164	195	75	9	1
148	214	79	10	1
131	214	82	10	1
115	214	79	10	1
98	214	82	10	1

TD / 2R

▽▽	H(ft)	D■(ft)	⊠	≡
213	177	66	8	1
197	177	69	8	1
180	177	72	8	1
164	177	75	8	1
148	177	79	8	1
131	177	85	8	1
115	177	85	8	1
98	177	92	8	1

≡ TR24/TSR20

⊠ TR24-5,6

ASRD 20/24 156.21.000
AR24 156.21.200

BRI 10-24 156.20.500
ABH 100C 170.23.000

H= Máxima altura de torre sin arriostrar (ft) / Maximum tower height without fastening (ft)

*Dmin ■

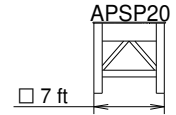

(H) ESTACIONARIA / STATIONARY

TD

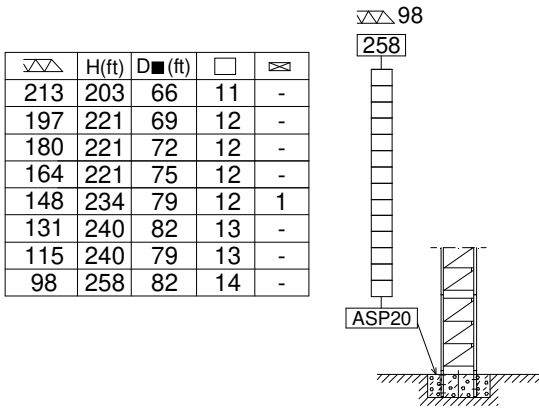

TD / 2R

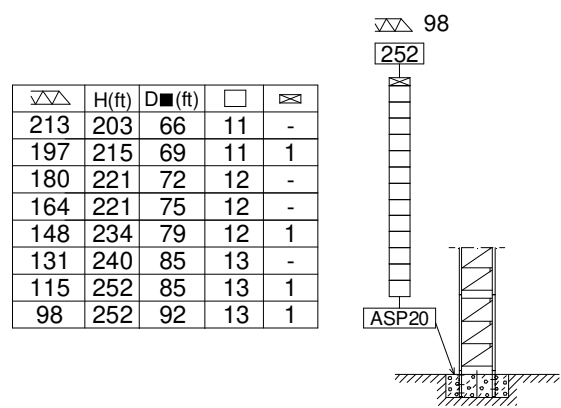

(H) ESTACIONARIA 3 / STATIONARY 3

TD

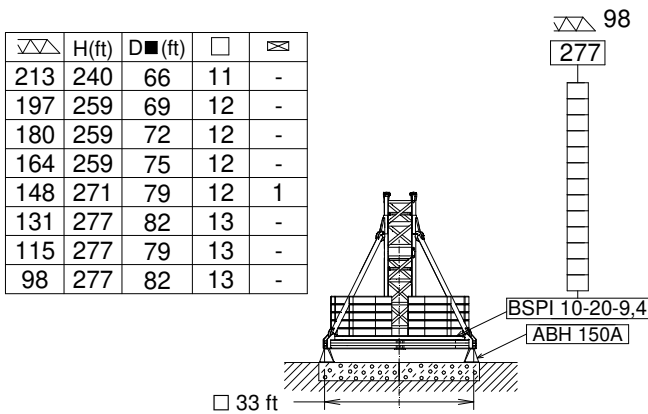

TD / 2R

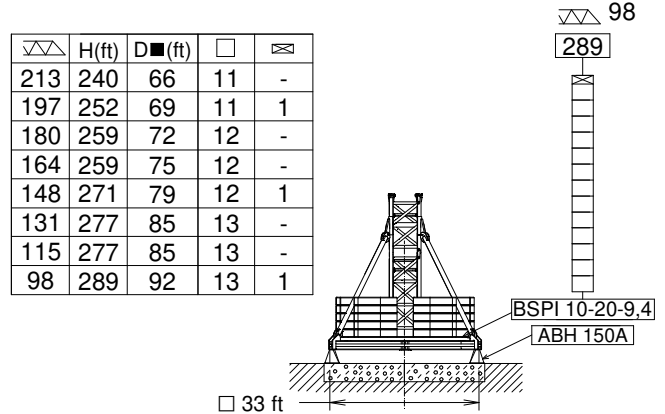

(H) TRASLACION / TRAVELLING

TD

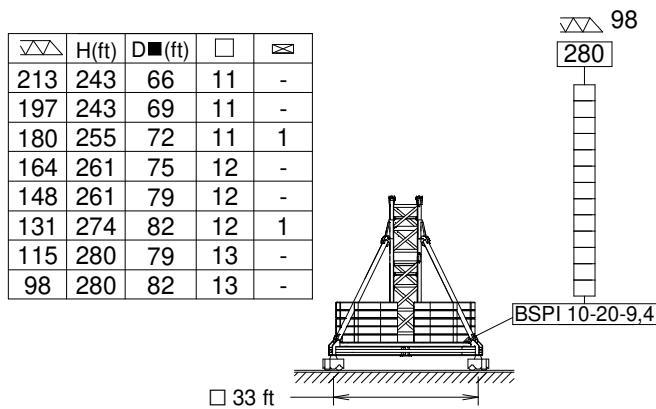

TD / 2R

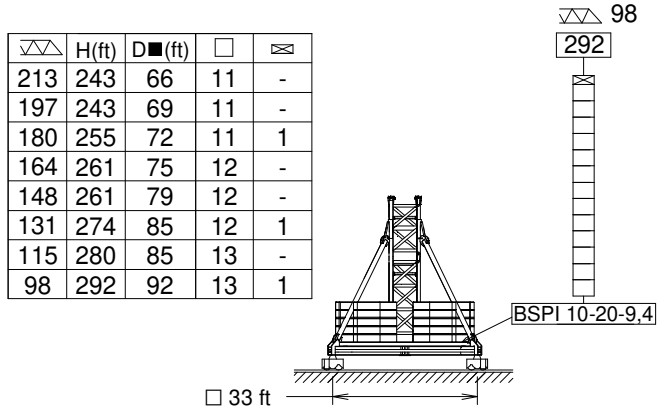

⊠ TSP20

□ TSP20-5,6

ASP20212.21.200

ABH 150A 212.23.000

H= Máxima altura de torre sin arriostrar (ft) / Maximum tower height without fastening (ft)

CARGAS / LOADS

J638PA



TD - 35300 lb



	TD 35300 lb @ ... (ft)	82	98	115	131	148	164	180	197	213
213	143	35300	35300	35300	35300	33300	27800	23100	19200	15900
197	146	35300	35300	35300	35300	34400	28900	24300	20300	—
180	148	35300	35300	35300	35300	35300	29500	24900	—	—
164	151	35300	35300	35300	35300	35300	30600	—	—	—
148	148	35300	35300	35300	35300	35300	—	—	—	—
131	131	35300	35300	35300	35300	—	—	—	—	—
115	115	35300	35300	35300	—	—	—	—	—	—
98	98	35300	35300	—	—	—	—	—	—	—



CARGAS / LOADS



J638PA

TD/2R - 35300 / 70500 (lb)



	2R 70500 lb @ (ft)	TD 35300 lb @ (ft)	66	82	98	115	131	148	164	180	197	213
213	70500 lb @ (ft)	138	35300	35300	35300	35300	35300	31500	26000	21400	17600	14300
197		141	35300	35300	35300	35300	35300	32800	27300	22700	18700	—
180	88	143	70500	70500	61100	49400	40600	33700	28000	23400	—	—
164	90	146	70500	70500	62400	50700	41700	34800	29100	—	—	—
148	92	148	70500	70500	64400	52500	43400	36400	—	—	—	—
131	94	131	70500	70500	66600	54500	45200	—	—	—	—	—
115	96	115	70500	70500	68800	56400	—	—	—	—	—	—
98	98	98	70500	70500	70500	—	—	—	—	—	—	—

	2R 39700 lb @ (ft)	TD 19800 lb @ (ft)										
			82	98	115	131	148	164	180	197	213	
213	128	190	39700	39700	39700	39500	31500	26000	21400	17600	14300	

	2R 57300 lb @ (ft)	TD 28700 lb @ (ft)										
			66	82	98	115	131	148	164	180	197	
197	102	159	57300	57300	57300	48500	39700	32800	27300	22700	18700	

Datos válidos para / Valid data for:



2R H ≤ 361 ft
TD H ≤ 722 ft



FEM 1005 - C25



Reservado el derecho a modificaciones sin previo aviso. Declinamos toda responsabilidad derivada de la información proporcionada / Subject to modification, without prior notice. This information is supplied without liability



EC150152VF
110 kW

*** EC180188VF**
132 kW

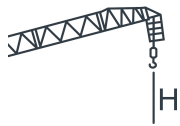
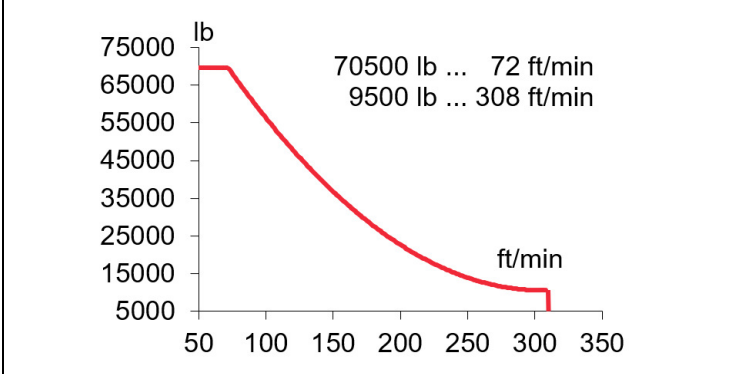
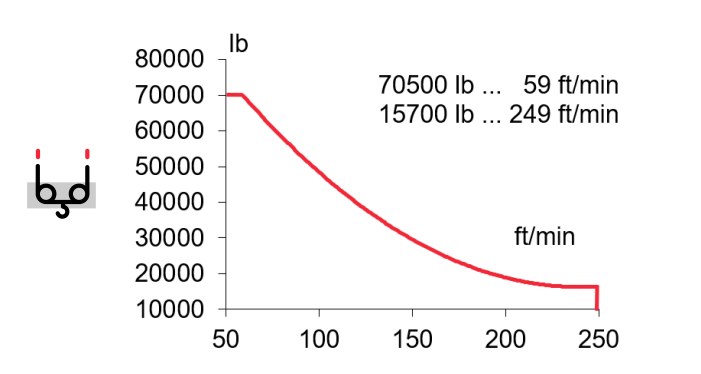
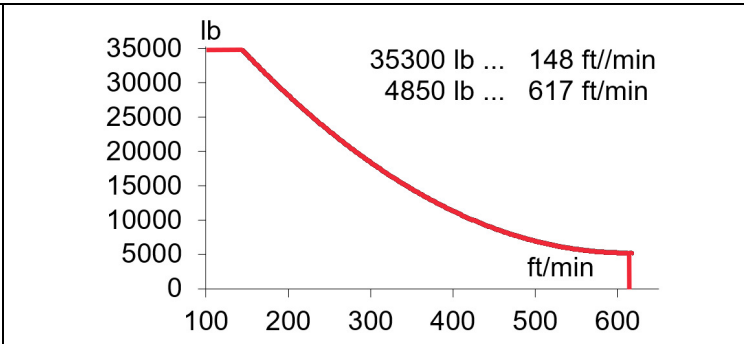
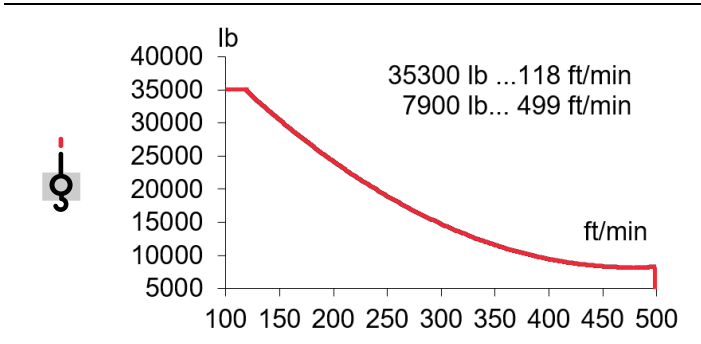

$H \leq \frac{TD}{2R}$
2133 ft
1066 ft

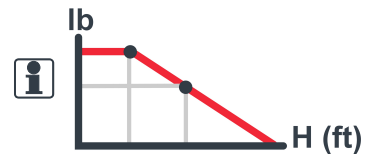

OG2008VF
2 X 7,3 kW

0...0,8
r/min
sl/min



EP10015VF
75 kW

1,5
min



TG4025VF
4 x 7,5 kW

0...82
ft/min

⚡ 3~ 400V 50Hz
480V 60Hz

KVA			
EC150152VF	103	146	189
EC180188VF	114	162	210









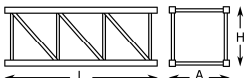
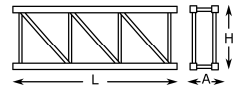
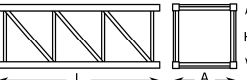
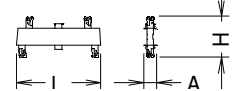
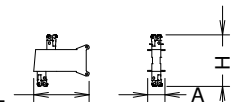

FEM 1005 - C25

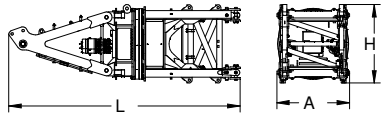

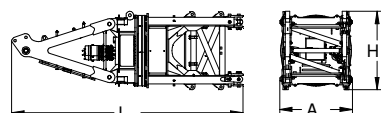
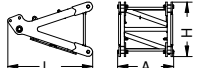
LISTA DE EMBARQUE / PACKING LIST

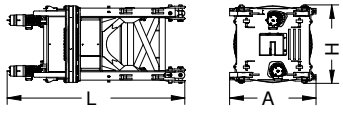
J638PA

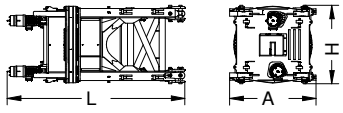
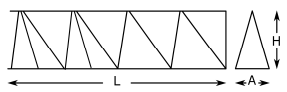
			L (ft)	A (ft)	H (ft)	P/W (Lb)
Torre inferior / Lower tower	TRID24-5,6		19.7	7.0	7.1	18190
Torre desmontada / Dismantled tower	TRD24-5,6		19.7	8.3	3.9	10850
Torre / Tower	TR24-5,6 TSP20 TSP20-5,6		19.7 14.4 20.2	8.9 7.5 7.5	9.2 7.8 7.8	9900 12380 16900
Larguero largo, reducción / Long crossbar, reduction	TR24/TSR20		15.9	2.1	5.5	6280
Larguero corto reducción / Short crossbar, reduction	TR24/TSR20		7.8	1.9	5.5	3190
Torre asiento pista + Torre superior + Orientación / Slewing table + Top tower + Slewing mechanism	APSR20 		24.7	7.8	8.3	41450
Torre asiento pista + Torre superior + Orientación / Slewing table + Top tower + Slewing mechanism	APSP20 		24.7	7.6	8.6	49600
Punta de torre / Tower head			11.0	7.3	6.8	12790
Torre asiento pista + Base punta de torre + Orientación Slewing table + Tower head base + Slewing mechanism	APSR20 		17.1	8.3	7.8	28660
Torre asiento pista + Base punta de torre + Orientación Slewing table + Tower head base + Slewing mechanism	APSP20 		17.1	7.6	8.3	36820
Tramo de pluma / Jib section	1 2 3 4 5 6 7 8 9		20.3 34.3 34.5 34.6 34.6 34.6 18.4 12.2 6.6	7.1 5.0 5.0 5.0 4.9 4.9 4.9 4.9 6.2	5.8 5.7 5.7 5.7 5.7 5.7 5.7 6.1 6.7	4030 5560 5270 4760 4320 3860 2270 2250 2230



FEM 1005 - C25



Reservado el derecho a modificaciones sin previo aviso. Declinamos toda responsabilidad derivada de la información proporcionada / Subject to modification, without prior notice. This information is supplied without liability

LISTA DE EMBARQUE / PACKING LIST

J638PA

		L (ft)	A (ft)	H (ft)	P/W(Lb)
<p>Contrapluma + Mecanismos + Pasteca + Plumin (sin cable de elevación) / Counterjib + Mechanisms + Reeving block + Auxiliary jib (without hoisting rope)</p>		29.9	7.8	9.1	56220
<p>Contrapluma + Elevacion pluma + Pasteca + Plumin Counterjib + Luffing mechanisms + Reeving block + Auxiliary jib</p>		29.9	7.2	8.4	37700
<p>Mecanismo elevacion carga sin cable / Hoisting mechanism without rope</p>		8.0	8.1	7.1	18520
<p>Polipasto / Hook assembly</p>	<p>TD/2R TD</p>	3.3 0.6	1.4 1.1	6.5 6.9	1730 840
<p>Tirante sostén pluma / Jib support tie</p>		17.7	1.4	2.0	4740
<p>Parte superior / Top part</p>		39.2	7.2	6.8	28880
<p>Plataforma + Cabina / Platform + Cabin</p>		12.0	6.3	8.1	2760
<p>Contrapeso / Counterweight</p>	<p>Lastre / Ballast</p>	12.5	1.9	4.9	13230

TRANSPORTE / TRANSPORT

J638PA

	<p>H = 8 x TRD24-5,6 + TR24/TSR20 + ASRD 20/24 + </p>	<p>10 x </p>	<p>10 x </p> <p>APSR20 □ 9 ft</p>
	<p>H = 8 x TSP20-5,6 + ASPD 20/24 + </p>	<p>12 x </p>	<p>12 x </p> <p>APSP20 □ 7 ft</p>

FEM 1005 - C25



Reservado el derecho a modificaciones sin previo aviso. Declinamos toda responsabilidad derivada de la información proporcionada / Subject to modification, without prior notice. This information is supplied without liability

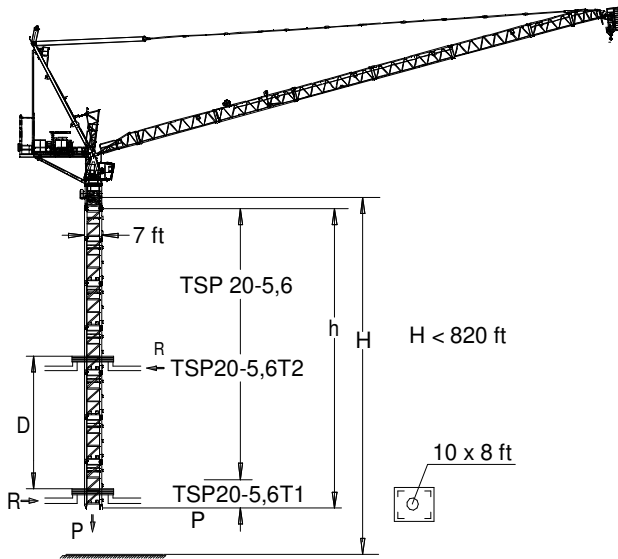
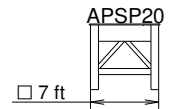

TSP20-5,6T1: 214.31.400
 TSP20-5,6T2: 214.31.600

h_{max} :
TSP20-5,6T1 + 8 x TSP20-5,6 + TSP20-5,6T2

h (ft)	184	
D (ft)	29 - 87	
P (lbf)	509190	437250
Rmax (lbf)	227510	435900

h_{max} :
TSP20-5,6T1 + 6 x TSP20-5,6 + TSP20-5,6T2

h (ft)	147	
D (ft)	31 - 68	
P (lbf)	486940	415000
Rmax (lbf)	203450	333620

Trepado interno / Internal climbing

Viento fuera de servicio / Out of service wind

Consultar / Consult

En servicio / In service

Fuera de servicio / Out of service

Opcional / Optional



Ctra./ Rd. Madrid – Irún - Km. 415 - 20213 IDIAZABAL (Gipuzkoa) - ESPAÑA / SPAIN
 P.O. Box, 23 - 20.200 - BEASAIN - E-mail: jaso@jaso.com
 Tel. +34 943 - 18 70 00 • Fax. +34 943 - 18 70 20
www.jaso.com

07/05/2026

FEM 1005 – C25
 DELEGACIÓN / DEALER