



J265PA

UNE 58-101
FEM 1001

GRUA TORRE / TOWER CRANE
GRUE A TOUR / TURMDREHKRAN / БАШЕННЫЙ КРАН / رافعة برجية

FEM 1001

UNE-EN-ISO 9001

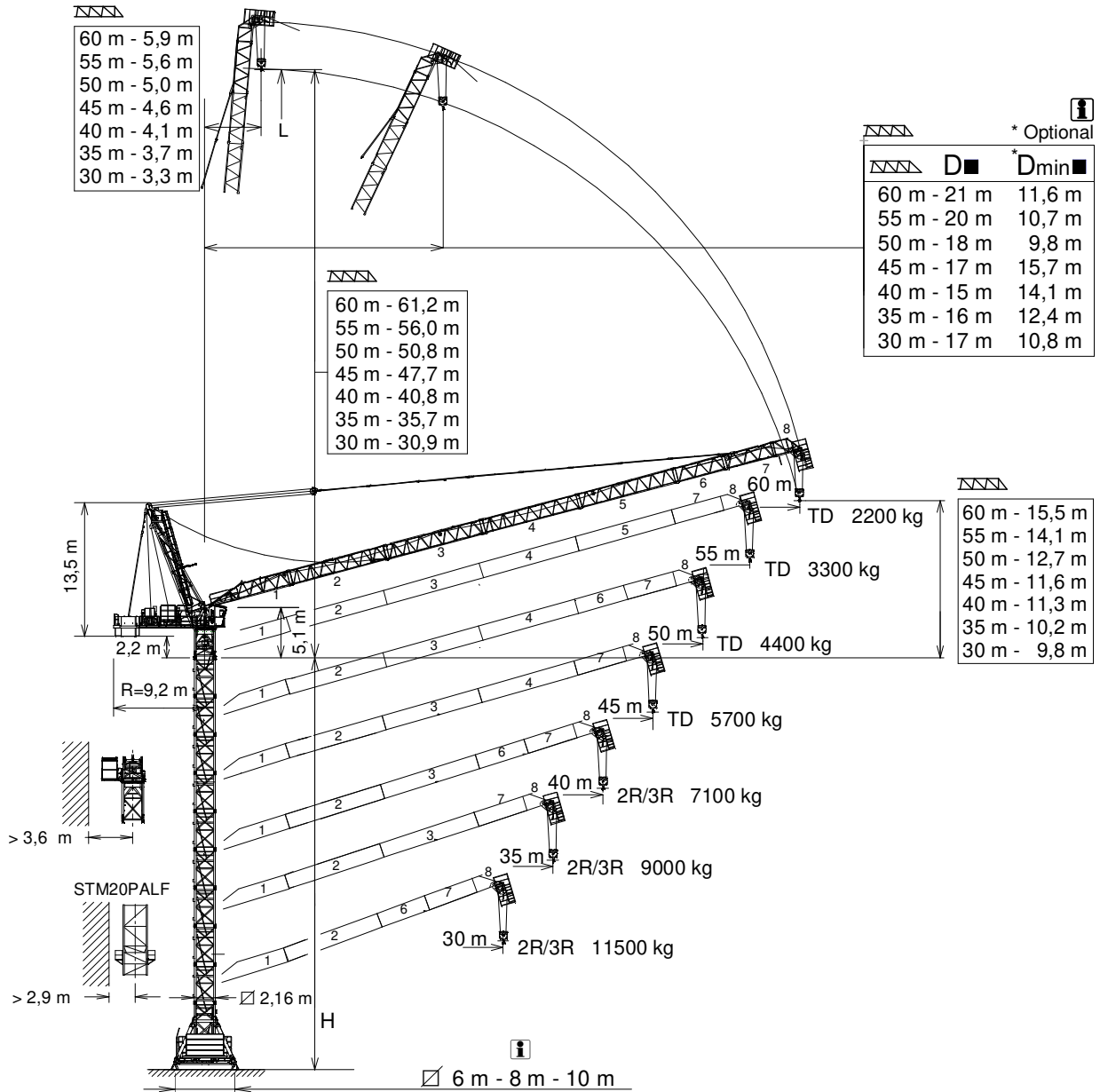

H= Máxima altura de torre sin arriostrar (m). / Maximum tower height without fastening (m)

Hauteur maximale de tour sans ancrage (m). / Maximale Höhe ohne Verstreben (m) / Максимальная высота башни без крепления (м). / أقصى ارتفاع للبرج بدون ربط (م)

* Tramo pluma / Jib section / Tronçon de flèche / Auslegerabschnitt / Секция стрелы / أجزاء الذراع

** Punta de pluma / Jib end / Pointe de flèche / Auslegerspitze / Конеч стрелы / مقدمة الذراع

D ■ Distancias fuera de servicio dependen de la altura de la torre / Out of service distances depend on tower height / Distances hors service dépendent de la hauteur de la tour / Die Außerbetriebnahmereichweiten hängen von der Höhe des Turms ab

*Dmin ■ Distancias mínimas fuera de servicio dependen de la altura de la torre / Out of service minimum distances depend on tower height / Distances minimales hors service dépendent de la hauteur de la tour / Die Mindestabstände außer Betrieb von der Höhe des Turms ab

*Tramo pluma 1 / Jib section 1	211.40.000
*Tramo pluma 2 / Jib section 2	211.41.000
*Tramo pluma 3 / Jib section 3	211.42.000
*Tramo pluma 4 / Jib section 4	211.43.000

*Tramo pluma 5 / Jib section 5	211.44.000
*Tramo pluma 6 / Jib section 6	211.45.000
*Tramo pluma 7 / Jib section 7	211.46.000
**Punta pluma 8 / Jib end 8	207.46.000

TS20	153.31.600
TS20-5,6	204.31.200
TSR20-5,6	206.31.000
TSR20-5,6A	206.31.300

CUSTOMIZE YOUR CRANE

OPTIMUS
line JASD



OPTI Cubo



TC Diagnosis SYSTEM



CLIMBING Solution



SAFETY Pack



Customization



ECO Mode



COMFORT Cabin



HIGH POWER Motors



JL25 Tower Crane Elevator



BE SMART keep control



Reservado el derecho a modificaciones sin previo aviso. Declinamos toda responsabilidad derivada de la información proporcionada / Subject to modification, without prior notice. This information is supplied without liability / L'entreprise se réserve le droit de procéder à des modifications sans préavis. Nous déclinons toute responsabilité quant aux informations fournies / Das Recht auf Änderungen ohne vorherige Ankündigung bleibt vorbehalten. Wir übernehmen keine Gewähr für die gemachten Angaben / Мы оставляем за собой право на внесение изменений без предварительного уведомления. Мы снимаем с себя любую ответственность в отношении предоставленной информации / حقوق التغيير محفوظة دون إشعار مسبق. بدون أدنى مسؤولية عن المعلومات المقدمة

31/01/2025



	TD 6 t @ ... (m)	25	30	35	40	45	50	55	60
60	41,5	6,0	6,0	6,0	6,0	5,1	3,9	3,0	2,2
55	42,6	6,0	6,0	6,0	6,0	5,4	4,3	3,3	—
50	43,2	6,0	6,0	6,0	6,0	5,5	4,4	—	—
45	43,8	6,0	6,0	6,0	6,0	5,7	—	—	—
40	40,0	6,0	6,0	6,0	6,0	—	—	—	—
35	35,0	6,0	6,0	6,0	—	—	—	—	—
30	30,0	6,0	6,0	—	—	—	—	—	—



TD/2R/3R - 6/12/18 t



	3R 18 t @ (m)	2R 12 t @ (m)	TD 6 t @ (m)	20	25	30	35	40	45	50	55	60
60	27,5	41,0	12,0	12,0	10,5	8,1	6,3	4,9	3,8	2,8	2,0	
55												27,9
50	20,9	28,1	42,6	18,0	14,2	10,9	8,5	6,8	5,4	4,2	—	—
45	20,9	28,2	43,1	18,0	14,2	11,0	8,7	6,9	5,5	—	—	—
40	21,1	28,6	40,0	18,0	14,4	11,2	8,9	7,1	—	—	—	—
35	21,1	28,8	35,0	18,0	14,5	11,3	9,0	—	—	—	—	—
30	21,3	29,1	30,0	18,0	14,7	11,5	—	—	—	—	—	—

Datos válidos para / Valid data for
Données valables pour / Gultige Daten für / Допустимые данные для / البيانات الصالحة لـ

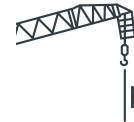

3R H ≤ 90 m
2R H ≤ 135 m
TD H ≤ 270 m



EC88110V
65 kW

*** EC150185VF**
110 kW

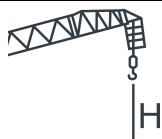
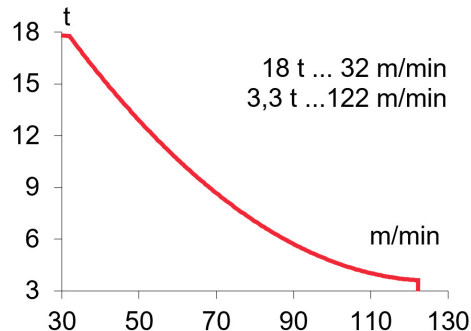
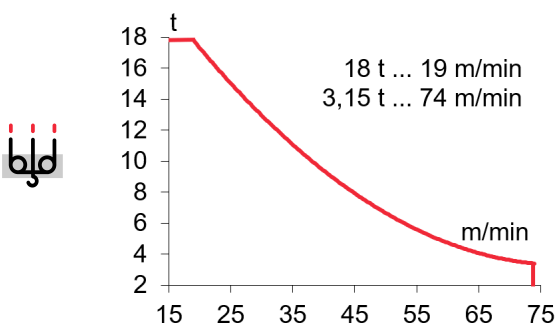
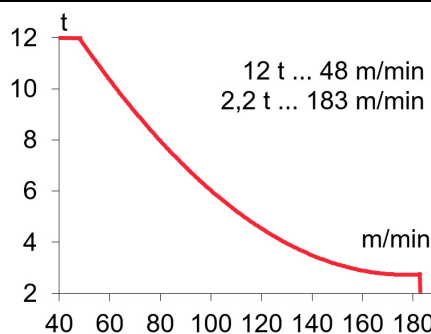
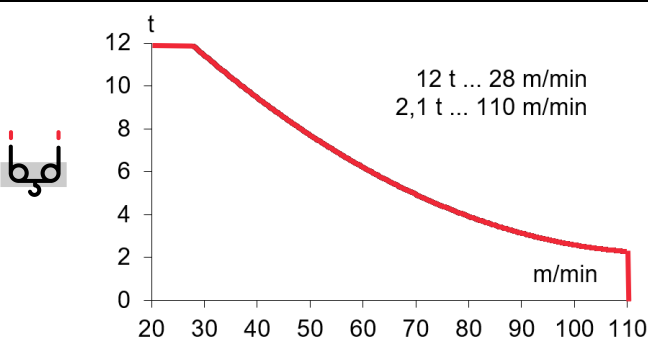
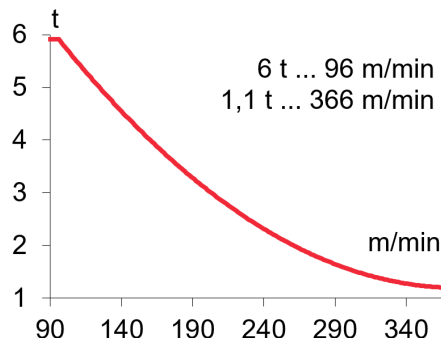
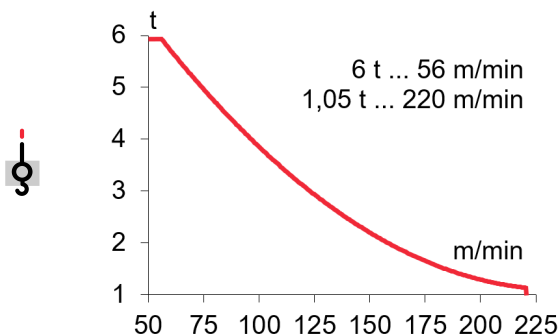

TD 630 m
H ≤ 2R 315 m
3R 210 m

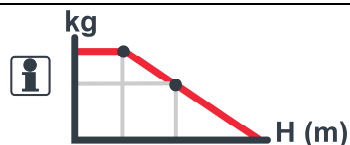

0...0,8
r/min
sl/min

1,5
min

0...20
m/min

0,6 m/min

⚡ 3~ 400V 50Hz
480V 60Hz

KVA			
EC88110VF	96	111	127
EC150185VF	118	144	171

*Dmin

(H) ESTACIONARIA / STATIONARY / STATIONAIRE / STATIONÄR / СТАЦИОНАРНОЕ СОСТОЯНИЕ / ثابتة

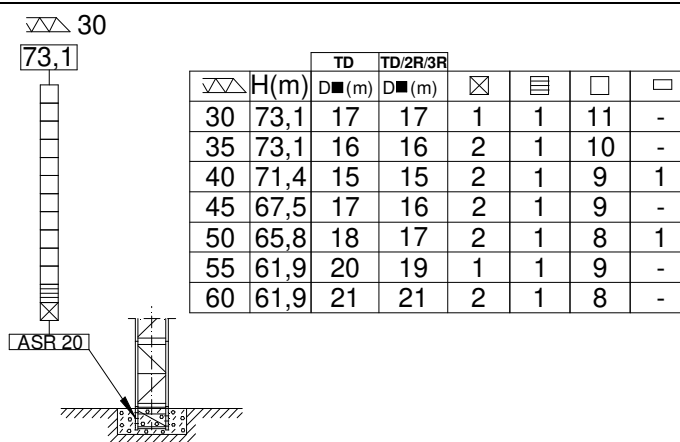
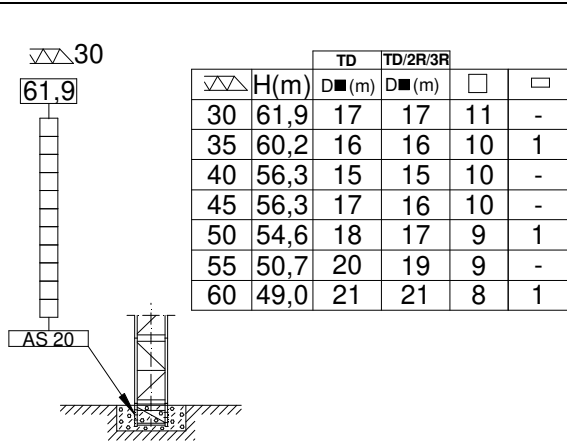

(H) ESTACIONARIA 3 / STATIONARY 3 / STATIONAIRE 3 / STATIONÄR 3 / СТАЦИОНАРНОЕ СОСТОЯНИЕ 3 / ثابتة 3

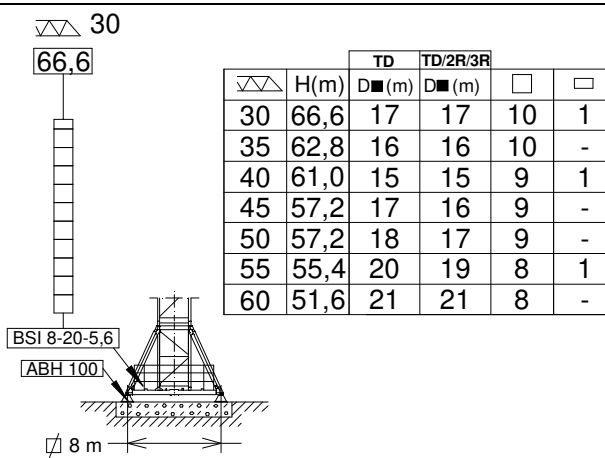
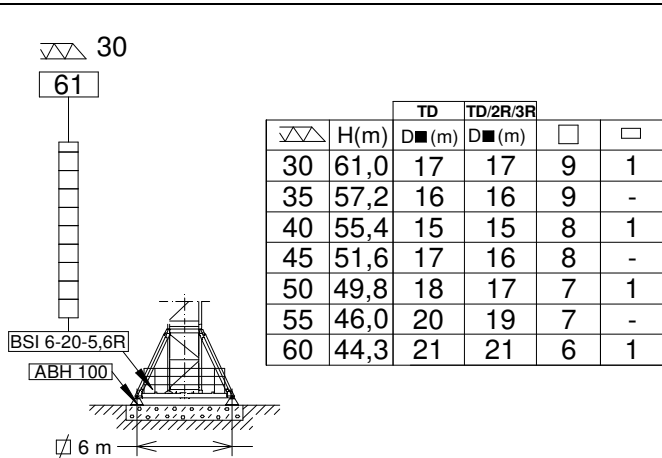

(H) TRASLACION / TRAVELLING / TRASLATION / FORTBEWEGUNG / ПЕРЕМЕЩЕНИЕ / متحركة

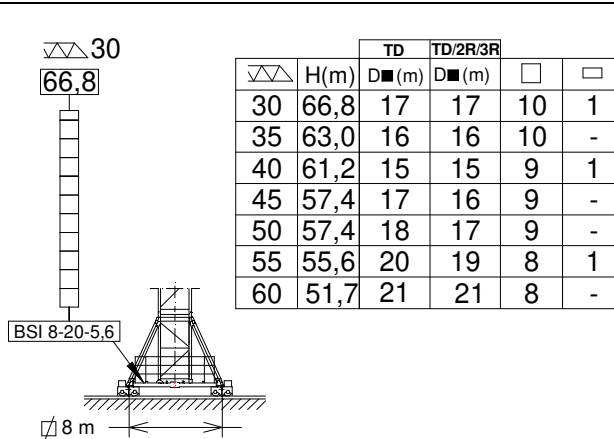
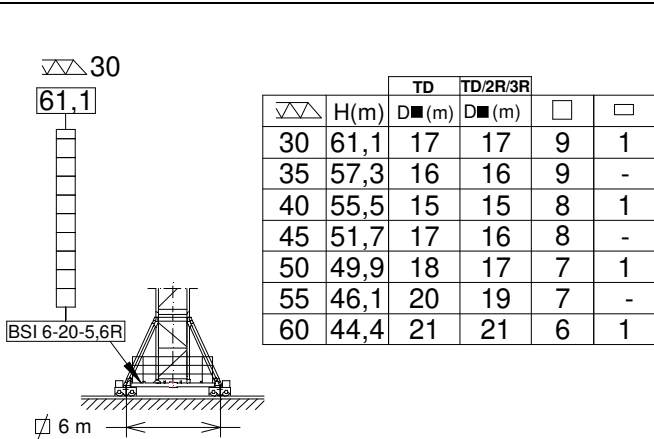

□ TS 20

□ TS 20-5,6

☒ TSR 20-5,6A

☒ TSR 20-5,6

H= Máxima altura de torre sin arriostrar (m). / Maximum tower height without fastening (m). / Hauteur maximale de tour sans ancrage (m). / Maximale Höhe ohne Verstreben (m) / Максимальная высота башни без крепления (м). / أقصى ارتفاع للبرج بدون ربط (م)

BSI6-20-5,6R 211.20.400
BSI8-20-5,6 211.20.000
ABH 100 201.23.000

AS20 160.21.010
ASR20 160.21.200



Reservado el derecho a modificaciones sin previo aviso. Declinamos toda responsabilidad derivada de la información proporcionada / Subject to modification, without prior notice. This information is supplied without liability. L'entreprise se réserve le droit de procéder à des modifications sans préavis. Nous déclinons toute responsabilité quant aux informations fournies / Das Recht auf Änderungen ohne vorherige Ankündigung bleibt vorbehalten. Wir übernehmen keine Gewähr für die gemachten Angaben / Мы оставляем за собой право на внесение изменений без предварительного уведомления. Мы снимаем с себя любую ответственность отнютии предоставленной информации / حقوق التغيير محفوظة دون إشعار مسبق. دون أننى مسؤولية عن المعلومات المقدمة.

COMPOSICIONES DE TORRE / TOWER COMPOSITIONS

COMPOSITIONS DE LA TOUR / TURMZUSAMMENSETZUNGEN / КОНСТРУКЦИЯ БАШНИ / برج مكونات

J265PA

i *Dmin

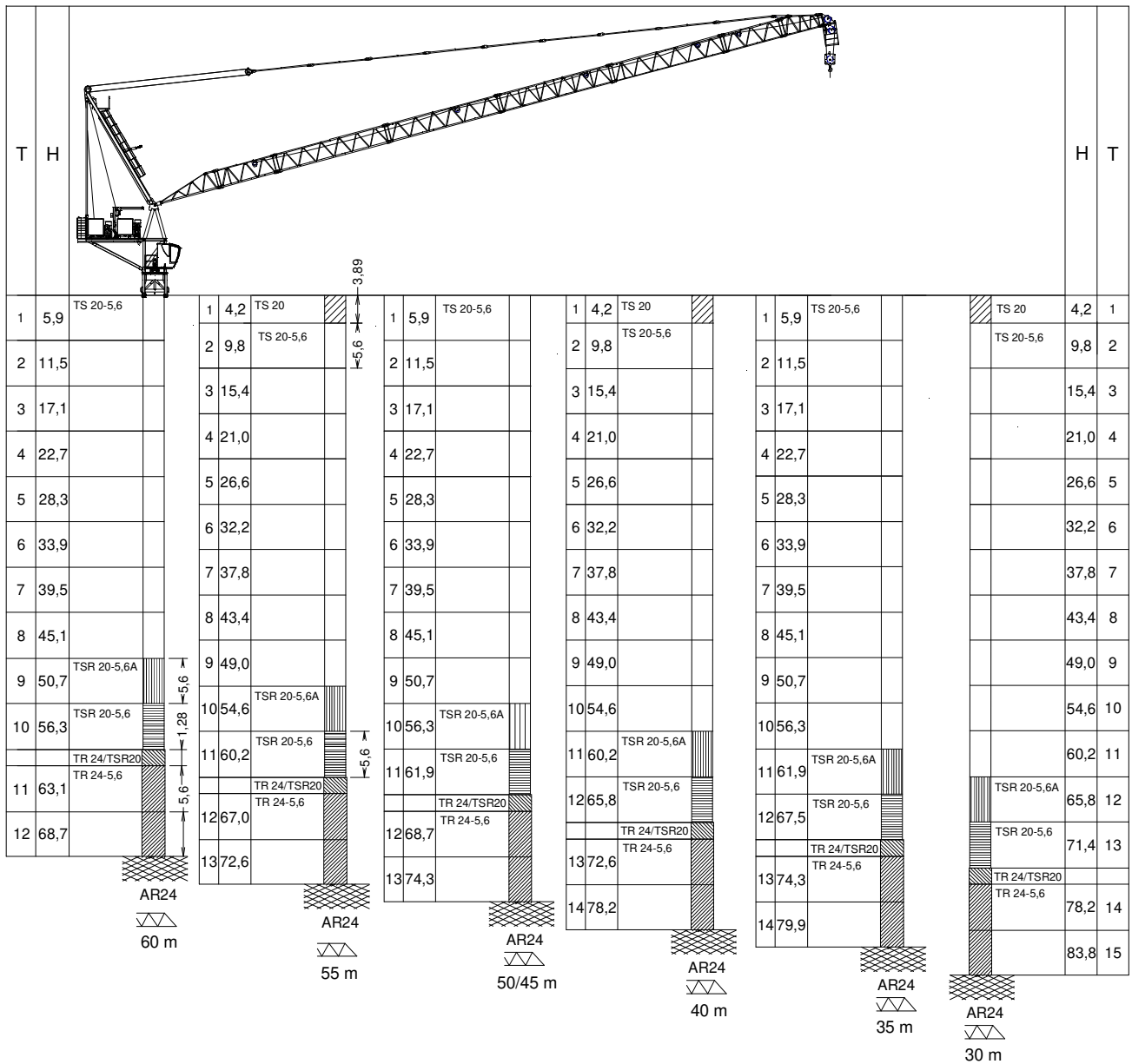

T : Torre / Tower / Tour / Turm / Башни / أبراج / ارتفاع
H : Altura / Height / Hauteur / Höhe / Высота / ارتفاع

TS20.....	153.31.600	TSR20-5,6A.....	206.31.300	TRD24-5,6	206.32.300
TS20-5,6.....	204.31.200	TR24/TSR20.....	204.36.500	AR24	156.21.200
TSR20-5,6.....	206.31.000	TR24-5,6	206.32.000		

i Otras configuraciones de torre / Other tower configuration / Autres configurations / Andere turmkonfigurationen / Прочие конфигурации / مكونات أخرى

TRANSPORTE / TRANSPORT / TRANSPORT / TRANSPORT / ТРАНСПОРТИРОВКА / نقل J265PA

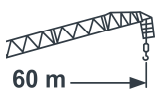

$$H = 8 \times \text{TS20-5,6} + 1 \times \text{TS20} + \text{AS20} + \text{[Crane Icon]}$$



7 x

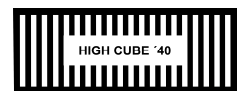

1 x

FLAT RACK 40'

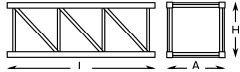
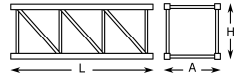
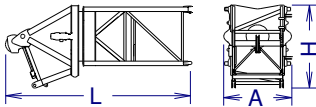
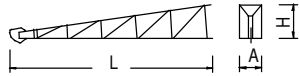
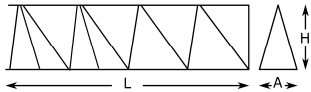
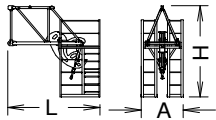
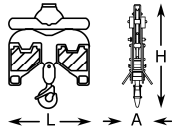
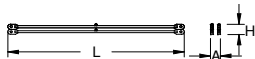
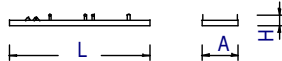

Reservado el derecho a modificaciones sin previo aviso. Declinamos toda responsabilidad derivada de la información proporcionada / Subject to modification, without prior notice. This information is supplied without liability. L'entreprise se réserve le droit de procéder à des modifications sans préavis. Nous déclinons toute responsabilité quant aux informations fournies / Das Recht auf Änderungen ohne vorherige Ankündigung bleibt vorbehalten. Wir übernehmen keine Gewähr für die gemachten Angaben / Мы оставляем за собой право на внесение изменений без предварительного уведомления. Мы снимаем с себя любую ответственность отнесенную предоставленной информации / حقوق التغيير محفوظة دون إشعار مسبق. دون أننى مسؤولة عن المعلومات المقدمة.

			L (m)	A (m)	H (m)	P/W(kg)
Torre inferior / Lower tower Tour inférieure / Unterer Turm Нижняя башня / البرج السفلى	TSI20-5,6		5,966	2,328	2,390	5390
Torre / Tower Tour / Turm / Башня / برج	TS20 TS20-5,6 TSR20-5,6A TSR20-5,6 TR24-5,6		4,236 5,966 5,926 5,990 5,990	2,335 2,328 2,388 2,257 2,760	2,348 2,390 2,325 2,257 2,835	2690 3550 4170 4210 4760
Torre asiento pista + base punta de torre + orientación Slewing table + tower head base + slewing mechanism Tour pivot + base du porte-flèche + mécanisme d'orientation Turmsitz + Turmspitzenbasis + Ausrichtung Сиденье площадки + основание верхней секции башни + поворотный механизм برج وحدة الدوارن + قاعدة رأس البرج + آلية الدوران			5,918	2,675	3,085	9900
Punta de torre + pasteca Tower head + reeving block Structure de porte-flèche + moufle et fléchette Turmspitze + Unterflasche رأس البرج			11,663	1,910	2,033	6000
Tramo de pluma Jib section Tronçon de flèche Auslegerabschnitt Секция стрелы أجزاء الذراع	1 2 3 4 5 6 7		9,250 10,200 10,200 10,200 10,200 5,310 5,293	2,090 1,266 1,266 1,266 1,266 1,266 1,266	1,770 1,604 1,597 1,577 1,577 1,577 1,630	1580 1490 1373 1225 1171 682 926
Punta de pluma Jib end Pointe de flèche Auslegerspitze Конец стрелы مقدمة الذراع			3,420	1,580	3,585	880
Polipasto Hook assembly Palan Flaschenzug Полиспаст بكرة			0,918	0,394	1,218	440
Tirante sostén pluma Jib support tie Tirant de fleche Haltestange Ausleger Растяжка поддержки مشد دعامة الذراع			5,842	0,360	0,370	1115
Estructura contrapluma Counterjib structure Structure de contre-flèche Konstruktion des Gegenauslegers Структура противовесной الذراع المعاكس			7,765	1,925	0,725	1437

		L (m)	A (m)	H (m)	P/W(kg)	
Contrapluma con mecanismos Counterjib with mechanisms Contre-flèche avec mécanismes Gegenausleger + Mechanismus Противовесная консоль с механизмами الذراع المعاكس مع الآليات		7,765	2,230	2,390	11800	
Plataforma y cabina / Platform and cabin Plateforme et cabine / Plattform + Führerstand Платформа и кабина / منصة وكابينة		3,420	2,060	2,400	1095	
Transporte torre de montaje Jacking cage transport Transport de tour de montage Transport Montageturm Транспортировка монтажной башни نقل برج التركيب	TM20PALF-5,6 	9,955	1,851	2,525	6615	
Mecanismos Mechanisms Mécanismes de Mechanismus Механизмы الآليات كهربائية	Elevación carga / Hoisting Levage de charge Hebewerk Подъем груза / رافع الحمولة		2,372	2,062	2,077	6200
	Elevación pluma / Luffing Relevage de flèche / Auslegerhebewerk Подъем стрелы / رافع الذراع		1,967	2,631	1,895	3200

TREPADO / CLIMBING / TÉLESCOPAGE / KLETTERSYSTEM / ЛЕСТНИЦА / التسلق

J265PA

***Dmin**

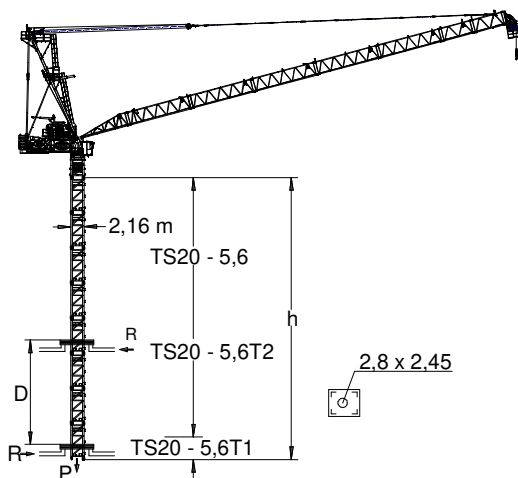

h_{max} :
 TS20-5,6T1 + 5 x TS20-5,6 + TS20-5,6T2

	▶	■
h (m)	39,5	
D (m)	11 - 18	
P (KN)	1224	1044
Rmax (KN)	371	551
	TS20-5,6T1: 160.32.600	
	TS20-5,6T2: 160.32.700	

Trepado interno / Internal climbing / Télescopage / Inneres klettersystem / Внутренняя лестница / التسلق الداخلي

Viento fuera de servicio / Out of service wind / Vitesse du vent hors service / Wind außer betrieb / Ветровая нагрузка в покое / الريح خارج الخدمة

Consultar / Consult / Nous consulter / Anfragen / Консультируйтесь / الرجوع إلى

En servicio / In service / En service / In betrieb / В работе / في الخدمة

Fuera de servicio / Out of service / Hors service / Außer betrieb / В покое / خارج الخدمة

*** Opcional / Optional / En option / Optional / Опция / اختياري**



Ctra./ Rd. Madrid – Irún - Km. 415 - 20213 IDIAZABAL (Gipuzkoa) - ESPAÑA / SPAIN
 P.O. Box, 23 - 20.200 - BEASAIN - E-mail: jaso@jaso.com
 Tel. +34 943 - 18 70 00 • Fax. +34 943 - 18 70 20
www.jaso.com

31/01/2025



DELEGACIÓN / DEALER

Reservado el derecho a modificaciones sin previo aviso. Declinamos toda responsabilidad derivada de la información proporcionada / Subject to modification, without prior notice. This information is supplied without liability / L'entreprise se réserve le droit de procéder à des modifications sans préavis. Nous déclinons toute responsabilité quant aux informations fournies / Das Recht auf Änderungen ohne vorherige Ankündigung bleibt vorbehalten. Wir übernehmen keine Gewähr für die gemachten Angaben / Мы оставляем за собой право на внесение изменений без предварительного уведомления. Мы снимаем с себя любую ответственность в отношении предоставленной информации / حقوق التغيير محفوظة دون إشعار مسبق. دون أدنى مسؤولية عن المعلومات المقدمة