

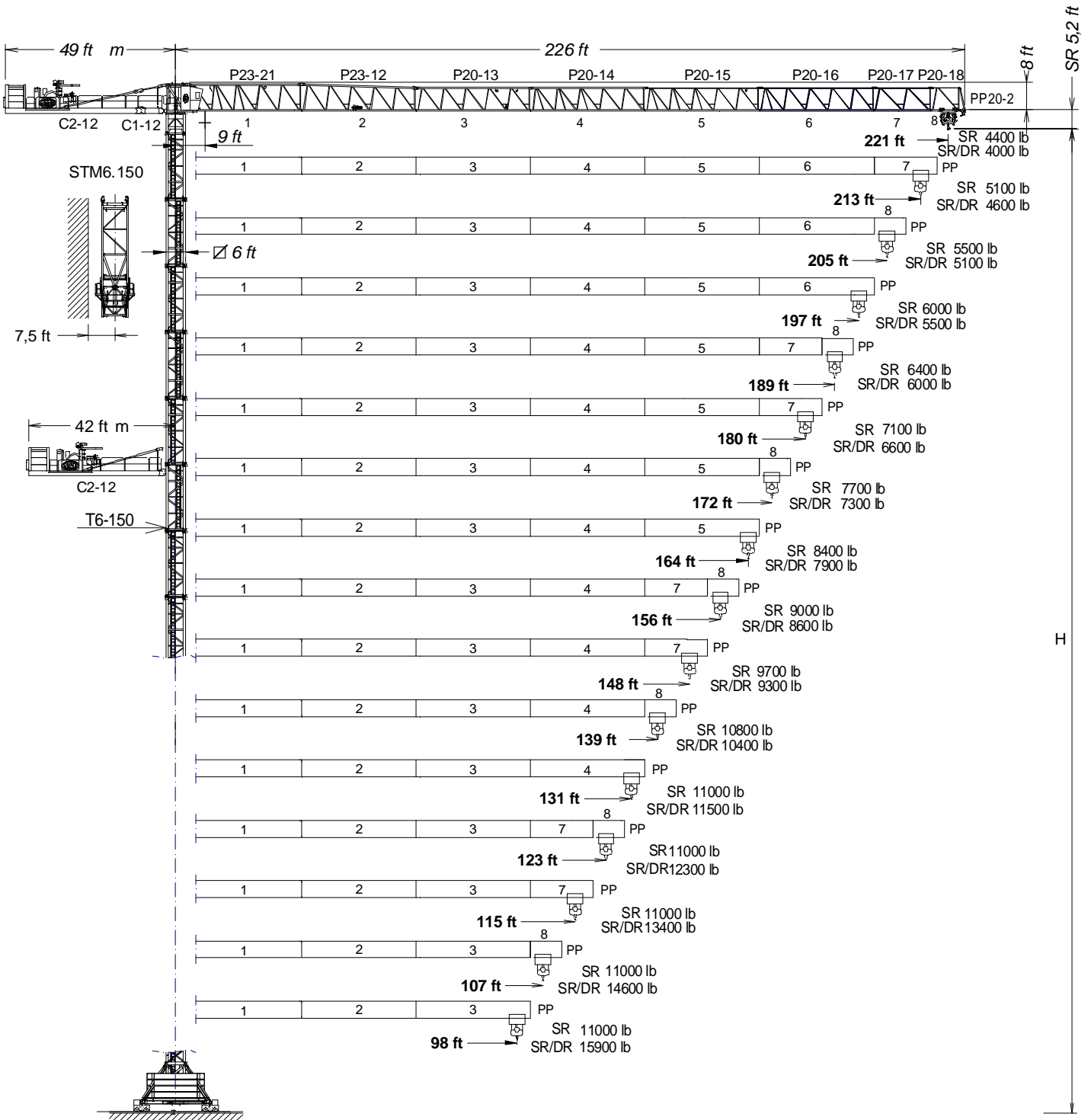

EN 14439
C25

UNE-EN-ISO 9001



C2-12	171.50.200	P20-14	171.43.000	PP20-2	171.47.500	AN 150	161.21.000
C1-12	171.50.050	P20-15	171.44.000	T3-150	161.32.000	BNI 45-150	161.20.500
P23-21	171.40.500	P20-16	171.45.000	T6-150	161.31.000	BNI 6-150	161.20.000
P23-12	171.41.000	P20-17	171.46.000	TD6-150	161.31.700	ABH 100	201.23.000
P20-13	171.42.000	P20-18	171.46.500	T12-150	161.31.500		

Fecha / Date: 24/08/2021

FEM 1005 - C25



Reservado el derecho a modificaciones sin previo aviso. Declinamos toda responsabilidad derivada de la información proporcionada / Subject to modification, without prior notice. This information is supplied without liability /

(H_{SR}) ESTACIONARIA 1 / STATIONARY 1

▽▽	H(m)	☒	☐
221 - 98	164	8	1

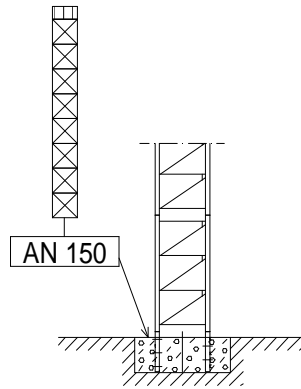

- ☐ T3-150
- ☒ T6-150
- ☒ TD6-150
- ☒ T12-150

(H_{SR}) ESTACIONARIA 3 / STATIONARY 3

▽▽	H(ft)	☒	☐
221	158	7	-
213 - 164	148	6	1
156 - 98	139	6	-

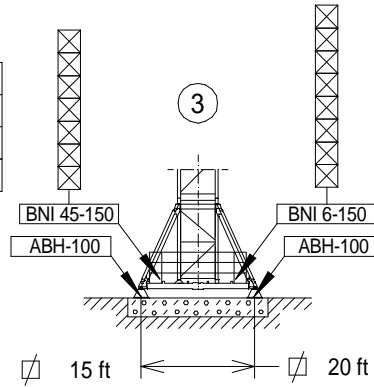

▽▽	H(ft)	☒	☐
221 - 189	167	7	1
180 - 98	177	8	-

- ☐ T3-150
- ☒ T6-150
- ☒ TD6-150
- ☒ T12-150

(H_{SR}) TRASLACIÓN / TRAVELLING

▽▽	H(ft)	☒	☐
221	158	7	-
213 - 164	149	6	1
156 - 98	139	6	-

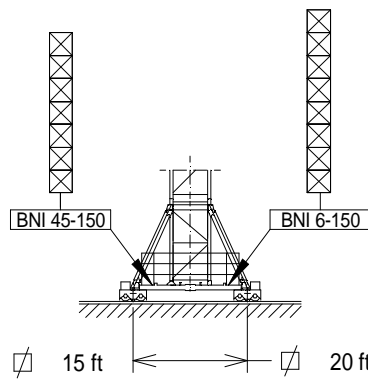

▽▽	H(ft)	☒	☐
221 - 189	168	7	1
180 - 98	178	8	-

- ☐ T3-150
- ☒ T6-150
- ☒ TD6-150
- ☒ T12-150

H = Altura máxima bajo gancho sin arriostrar (m).
Maximum height under hook without fastening (m).

$H_{SR} / DR = H_{SR} - 1 \text{ ft}$

CARGAS / LOADS

J200.10

SR (lb)		Cargas máximas / Maximum loads SR – 11000 lb																		
[ft]	11000 lb @... (ft)	Alcance del gancho [ft] / Hook reach [ft]																		
		49	66	82	98	107	115	123	131	139	148	156	164	172	180	189	197	205	213	221
221	100	11000	11000	11000	11000	10400	9500	8800	8200	7700	7100	6600	6400	6000	5700	5300	5100	4900	4600	4400
213	108	11000	11000	11000	11000	11000	10400	9500	8800	8400	7700	7300	6800	6600	6200	6000	5600	5300	5100	—
205	111	11000	11000	11000	11000	11000	10600	9900	9300	8600	8200	7500	7100	6800	6400	6200	5700	5600	—	—
197	114	11000	11000	11000	11000	11000	11000	10100	9500	8800	8400	7700	7300	7100	6600	6200	6000	—	—	—
189	116	11000	11000	11000	11000	11000	11000	10400	9700	9000	8400	7900	7500	7100	6800	6400	—	—	—	—
180	121	11000	11000	11000	11000	11000	11000	10800	10100	9500	8800	8400	7900	7500	7100	—	—	—	—	—
172	125	11000	11000	11000	11000	11000	11000	11000	10400	9700	9300	8600	8200	7700	—	—	—	—	—	—
164	128	11000	11000	11000	11000	11000	11000	11000	10800	10100	9500	8800	8400	—	—	—	—	—	—	—
156	130	11000	11000	11000	11000	11000	11000	11000	11000	10100	9700	9000	—	—	—	—	—	—	—	—
148	132	11000	11000	11000	11000	11000	11000	11000	11000	10400	9700	—	—	—	—	—	—	—	—	—
139	137	11000	11000	11000	11000	11000	11000	11000	11000	10800	—	—	—	—	—	—	—	—	—	—
131	131	11000	11000	11000	11000	11000	11000	11000	11000	—	—	—	—	—	—	—	—	—	—	—
123	123	11000	11000	11000	11000	11000	11000	11000	—	—	—	—	—	—	—	—	—	—	—	—
115	115	11000	11000	11000	11000	11000	11000	—	—	—	—	—	—	—	—	—	—	—	—	—
107	107	11000	11000	11000	11000	11000	—	—	—	—	—	—	—	—	—	—	—	—	—	—
98	98	11000	11000	11000	11000	—	—	—	—	—	—	—	—	—	—	—	—	—	—	—

CARGAS / LOADS

J200.10







SR/DR (lb)		Cargas máximas / Maximum loads SR / DR – 11000 / 22000 lb																		
[ft]	11000 / 22000 lb @... (ft)	Alcance del gancho [ft] / Hook reach [ft]																		
		49	66	82	98	107	115	123	131	139	148	156	164	172	180	189	197	205	213	221
221	97 / 52	11000 / 22000	11000 / 17000	11000 / 13200	10800	9900	9000	8400	7700	7300	6600	6200	6000	5500	5300	4900	4600	4400	4200	4000
213	105 / 56	11000 / 22000	11000 / 18500	11000 / 14600	11000 / 11900	10800	9900	9000	8400	7900	7300	6800	6400	6200	5700	5500	5100	4900	4600	—
205	108 / 57	11000 / 22000	11000 / 19200	11000 / 15000	11000 / 12100	11000 / 11200	10100	9500	8800	8200	7700	7100	6600	6400	6000	5700	5300	5100	—	—
197	110 / 59	11000 / 22000	11000 / 19600	11000 / 15400	11000 / 12600	11000 / 11500	10600	9700	9000	8400	7900	7300	6800	6600	6200	5700	5500	—	—	—
189	113 / 60	11000 / 22000	11000 / 20100	11000 / 15700	11000 / 12800	11000 / 11700	10800	9900	9300	8600	7900	7500	7100	6600	6400	6000	—	—	—	—
180	117 / 62	11000 / 22000	11000 / 20900	11000 / 16300	11000 / 13400	11000 / 12300	11000 / 11200	10400	9700	9000	8400	8000	7500	7100	6600	—	—	—	—	—
172	121 / 64	11000 / 22000	11000 / 21600	11000 / 17000	11000 / 13900	11000 / 12800	11000 / 11700	10800	9900	9300	8800	8200	7700	7300	—	—	—	—	—	—
164	124 / 66	11000 / 22000	11000 / 22000	11000 / 17400	11000 / 14300	11000 / 13000	11000 / 11900	11000	10400	9700	9000	8400	7900	—	—	—	—	—	—	—
156	126 / 67	11000 / 22000	11000 / 22000	11000 / 17600	11000 / 14600	11000 / 13200	11000 / 12100	11000 / 11200	10600	9700	9300	8600	—	—	—	—	—	—	—	—
148	127 / 68	11000 / 22000	11000 / 22000	11000 / 17900	11000 / 14600	11000 / 13500	11000 / 12300	11000 / 11500	10600	9900	9300	—	—	—	—	—	—	—	—	—
139	132 / 70	11000 / 22000	11000 / 22000	11000 / 18700	11000 / 15200	11000 / 14100	11000 / 13000	11000 / 11900	11000	10400	—	—	—	—	—	—	—	—	—	—
131	131 / 72	11000 / 22000	11000 / 22000	11000 / 19200	11000 / 15900	11000 / 14600	11000 / 13200	11000 / 12300	11000 / 11500	—	—	—	—	—	—	—	—	—	—	—
123	123 / 73	11000 / 22000	11000 / 22000	11000 / 19200	11000 / 15900	11000 / 14600	11000 / 13200	11000 / 12300	—	—	—	—	—	—	—	—	—	—	—	—
115	115 / 73	11000 / 22000	11000 / 22000	11000 / 19400	11000 / 15900	11000 / 14600	11000 / 13400	—	—	—	—	—	—	—	—	—	—	—	—	—
107	107 / 73	11000 / 22000	11000 / 22000	11000 / 19400	11000 / 15900	11000 / 14600	—	—	—	—	—	—	—	—	—	—	—	—	—	—
98	98 / 73	11000 / 22000	11000 / 22000	11000 / 19400	11000 / 15900	—	—	—	—	—	—	—	—	—	—	—	—	—	—	—





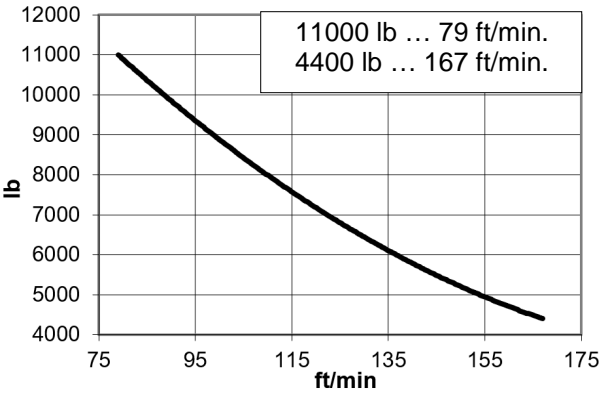
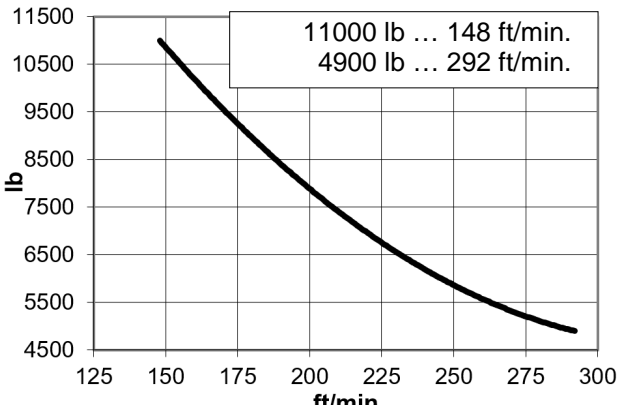

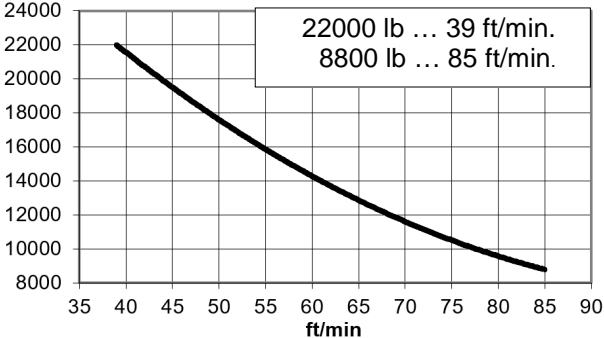
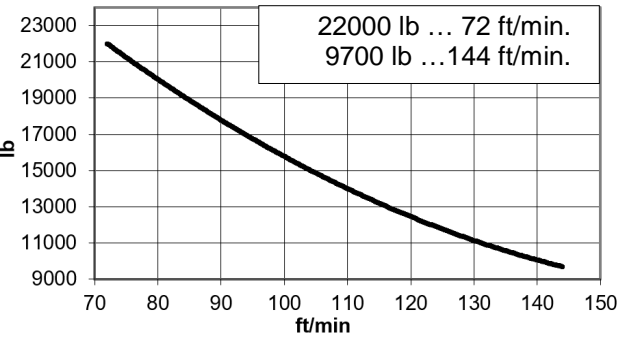
Fecha / Date: 24/08/2021

 **FEM 1005 - C25**



Reservado el derecho a modificaciones sin previo aviso. Declinamos toda responsabilidad derivada de la información proporcionada / Subject to modification, without prior notice. This information is supplied without liability /

*opcional *optional *en option *опция *opsiyonel *اختياري		
	EC3351VF 24,3 kW	*EC6089VF 44,1 kW
		
		
	$H \leq$ SR 1142 ft DR 571 ft	$H \leq$ SR 1752 ft DR 876 ft
	2989 ft	4521 ft

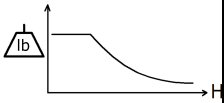
				 480V 60Hz	 
TG2020VF 2 x 7,3 kW	OG2208VF 3 x 5,5 kW	TC770VF 5,5 kW	TH1506 11 kW		
0...66 ft/min	0...0,8 r/min sl/min	11000 lb 0...230 ft/min 22000 lb 0...115 ft/min	3 ft/min	P_{TOTAL} (EC3351VF + OG2208VF + TC770VF) = 46,3 kW P_{TOTAL} (EC6089VF + OG2208VF + TC770VF) = 66,1 kW	

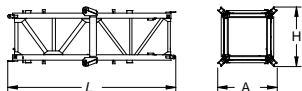
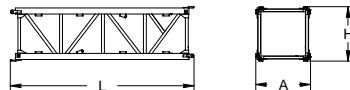
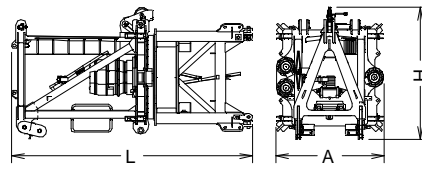
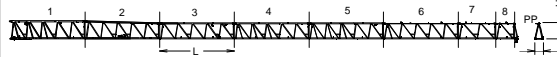
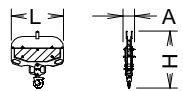
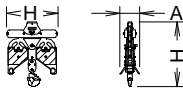
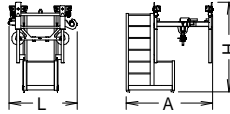
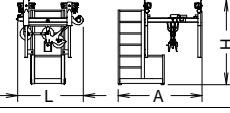
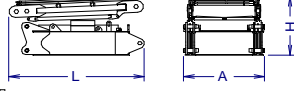
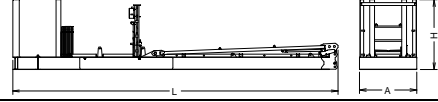
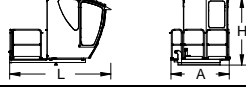
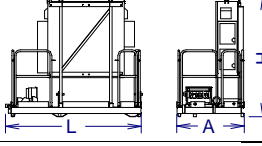
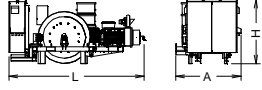
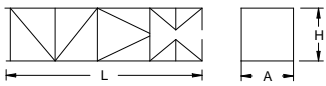
DENOMINACIÓN / DENOMINATION		L [ft]	A [ft]	H [ft]	P / W [lb]	
Torre inferior / Lower tower	TI-6-150		20.3	7.2	7.2	7790
Torre / Tower	T6-150		20.3	6.1	6.1	6080
	TD6-150		20.3	6.1	6.1	6460
	TT6-150		20.3	6.1	6.1	6080
	T3-150		10.7	6.1	6.1	3420
	T12-150		39.4	6.1	6.1	11420
Torre asiento pista + punta de torre + orientación Slewing table + tower head + slewing mechanism			15.2	6.8	8.2	15210
Tramo de pluma Jib section	P23-21		33.7	4.4	8.2	5680
	P23-12+tr		33.7	3.7	8.1	5670
	P20-13		33.6	3.7	7.3	3570
	P20-14		33.4	3.7	7.2	2630
	P20-15		33.4	3.7	7.1	1800
	P20-16		33.4	3.7	7.3	1260
	P20-17		17.0	3.7	7.3	770
	P20-18		8.8	3.7	7.2	420
	PP20-2		2.9	4.2	8.2	290
Polipasto / Hook assembly	SR – 11000 lb		3.0	0.7	3.4	375
	SR / DR – 22000 lb		3.1	1.2	4.0	720
Carro / Trolley	SR – 11000 lb		5.1	6.4	6.2	670
	SR / DR – 22000 lb		5.0	6.4	6.2	780
Contrapluma / Counterjib	C1-12		7.9	4.7	3.6	2380
Contrapluma / Counterjib	C2-12		39.3	6.9	8.2	12200
Plataforma y cabina / Platform and cabin			11.5	6.8	7.9	2470
Armario eléctrico y plataforma Electrical cabinet and platform			8.7	4.3	7.7	1800
Soporte y elevación (sin cable) Support and hoisting (without rope)			10.5	5.1	5.6	5300
Estructura torre de montaje Jacking cage structure	TM6-150		33.9	8.0	7.6	7720

T	H	Diagram				H	T	Legend
1	21					21	1	T3-150
2	40					40	2	T6-150
3	60					60	3	TL20/TX-150
4	79					79	4	TL20-5,6
5	98					98	5	TS20-5,6-A
6	117					117	6	TS20-5,6
7	136					136	7	TSR20-5,6-A
8	155					149	8	TSR20-5,6
9	168					167	10	TSR20-5,6
10	186					186	11	TSR20-5,6
		204	12	TSR20-5,6				
		222	13	TSR20-5,6				
		241	14	TSR20-5,6				

T: Torre / Tower H: Altura / Height	$H_{SR/DR} = H_{SR} - 1 \text{ ft}$	TL20/TX-150----- 161.36.000 TL20-5,6 ----- 204.31.400 TS20-5,6A ----- 204.31.500 TS20-5,6 ----- 204.31.200 TSR20-5,6A ----- 204.31.300 TSR20-5,6 ----- 204.31.000	AL 20----- 153.21.800 ALD 20 ----- 160.21.250 AS 20 ----- 160.21.010 ASD 20/24 ----- 160.21.080 ASR 20 ----- 160.21.200 ASRD 20/24 ----- 156.21.000
--	-------------------------------------	--	--

TRANSPORTE / TRANSPORT J200.10

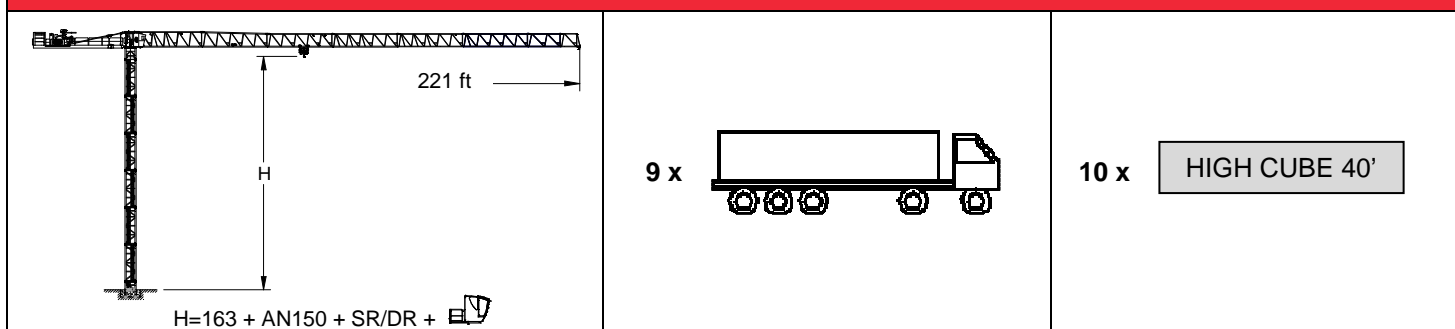

- Viento fuera de servicio
- Consultar / Consult
- En servicio / In service
- Fuera de servicio / Out of service



Ctra./Rd. Madrid - Irún Km. 415 - 20.213 IDIAZABAL [Gipuzkoa] ESPAÑA / SPAIN
 P.O. Box, 23 - 20.200 BEASAIN - E-mail: jaso@jaso.com
 Tel. +34 943 - 18 70 00 • Fax. +34 943 - 18 70 20
www.jaso.com

Fecha / Date: 24/08/2021

FEM 1005 - C25

DELEGACION / DEALER