

CARGAS / LOADS / CHARGES / LASTEN / НАГРУЗКИ / الأحمال

J1125.DC

	TD/2R (kg)	CARGAS / LOADS / CHARGES / LASTEN / НАГРУЗКИ / الأحمال TD/2R – 1250/2500
--	------------	--

**TRANSPORTE / TRANSPORT / TRANSPORT
TRANSPORT / ТРАНСПОРТИРОВКА / نقل**

Transporte grúa completa / Transport of whole crane
 Transport de la grue complete / Transport kompletter Kran
 Транспортировка крана в сборе / نقل الرافعة كاملة

Caja marítima / Liftvan
 Cadre pour transport maritime
 Seefrachtkiste
 Контейнер для транспортировки морским транспортом
 حاوية بحرية





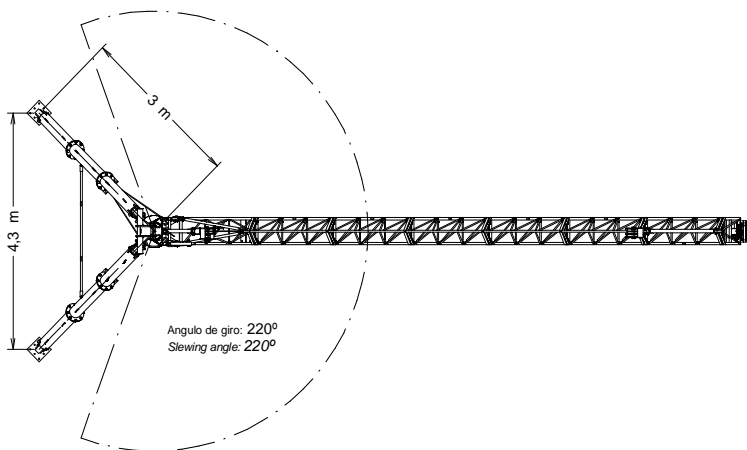



2800x2250x2000mm

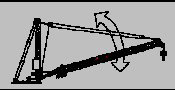

CARACTERÍSTICAS DE MECANISMOS / MECHANISMS FEATURES

J1125.DC











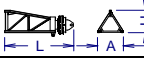

CARACTÉRISTIQUES DES MÉCANISMES / MERKMALE DER MECHANISMEN / ХАРАКТЕРИСТИКИ МЕХАНИЗМОВ / الخصائص الآلية

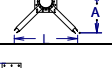
*opcional *optional *en option *optional *опция *اختياري		 EC530VF 4 kW		 EP515 4 kW	
	t m/min	0,7 0...30	1,25 0...18	1,5 min	
	t m/min	1,5 0...15	2,5 0...9		
 H		H ≤ TD 402 m 2R 201 m	 529 m		 400V 50Hz P_{TOTAL} (EC530VF + EP515) = 8 kW

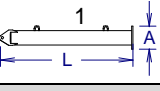
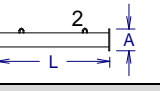
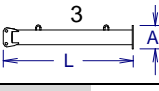
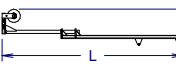
LISTA DE EMBARQUE / PACKING LIST

J1125.DC

LISTE DE COLISAGE / KOLLI LISTE / СПИСОК ПОСТАВКИ / قائمة التحميل

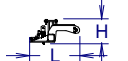
DENOMINACIÓN / DENOMINATION / DÉSIGNATION / BEZEICHNUNG / НАЗВАНИЕ / اسم	L (m)	A (m)	H (m)	P / W (kg)	
Torre inferior + orientación / Lower tower + slewing / Tour inférieure+ orientation Unterer Turm + Ausrichtung / Нижняя башня + поворотный механизм البرج السفلي + آلية الدوران		1,005	0,49	0,76	150
Punta de torre / Tower head / Porte-flèche Turmspitze / верхняя секция башни / قاعدة رأس البرج		1,312	0,49	0,44	108
Tramo de pluma - Torre / Jib section - Tower / Tronçon de flèche - Tour Auslegerabschnitt - Turm / Секция стрелы - Башня / أجزاء الذراع - برج		1,565	0,49	0,44	38
Tramo de pluma 1 / Jib section 1 / Tronçon de flèche 1 Auslegerabschnitt 1 / Секция стрелы 1 / 1 أجزاء الذراع		1,645	0,49	0,44	62
Punta de pluma / Jib end / Pointe de flèche / Конец стрелы / مقدمة الذراع		0,39	0,49	1,020	42
Base grúa / Crane base Base de la grue / Auslegerspitze / Основание крана / قاعدة الرافعة		1,300	0,875	-	72
Larguero inferior / Lower crossbar / Traverse inférieure Unterer Längsträger / Нижняя продольная балка / عارضة سفلية		2,380	0,320	-	78
Amarre puntales / Pillar fastening Fixation des mâts / Strebenbefestigung / Крепление стоек / مثبت دعمة		0,906	-	0,498	81
Puntal / Pillar / Mât / Strebe / Стойка / دعمة	 1  2  3	1,922 1,790 1,905	0,350 0,350 0,350	- - -	93 96 98
Plumín / Auxiliary jib Fléchette / Ausleger / Дополнительная стрела / ريشة اضافية		3,340	0,673	-	41
Polipasto / Hook assembly / Palan / Flaschenzug / Полиспаст / بكرة		0,387	0,841	-	210
Armario electric / Electrical cupboard / Armoire électrique / Stromkasten / Электрический шкаф / خزانة كهربائية		0,983	-	0,360	70
Pasteca / Reeving Block Bloc de renvoi / Unterflasche / Канифас-болк	 1  2	1,168 1,720	0,333 0,307	- -	40 42
Elevación pluma / Luffing Relevage de flèche / Auslegerhub / Подъем стрелы / / رافع الذراع		0,930	-	0,480	175
Elevación carga / Hoisting Levage de charge / Lasthub / Подъем груза / الحاملة / رافع الحمولة		1,043	-	0,795	278
Limitador sobrecarga / Overload limiter / Limiteur de surcharge Überlastsicherung / Ограничитель перегрузки / محدد الحمولة الزائدة		0,740	-	0,377	79



Ctra./Rd. Madrid - Irún Km. 415 - 20.213 IDIAZABAL [Gipuzkoa] ESPAÑA / SPAIN
 P.O. Box, 23 - 20.200 BEASAIN - E-mail: jaso@jaso.com
 Tel. +34 943 - 18 70 00 • Fax. +34 943 - 18 70 20
www.jaso.com

Fecha / Date: 11/10/2022



FEM 1005 - C25

DELEGACION / DEALER

Reservado el derecho a modificaciones sin previo aviso. Declinamos toda responsabilidad derivada de la información proporcionada / Subject to modification, without prior notice. This information is supplied without liability / L'entreprise se réserve le droit de procéder à des modifications sans préavis. Nous déclinons toute responsabilité quant aux informations fournies / Das Recht auf Änderungen ohne vorherige Ankündigung bleibt vorbehalten. Wir übernehmen keine Gewähr für die gemachten Angaben / Мы оставляем за собой право на внесение изменений без предварительного уведомления. Мы снимаем с себя любую ответственность в отношении предоставленной информации

حقوق التغيير محفوظة دون إشعار مسبق. دون أدنى مسؤولية عن المعلومات المقدمة