

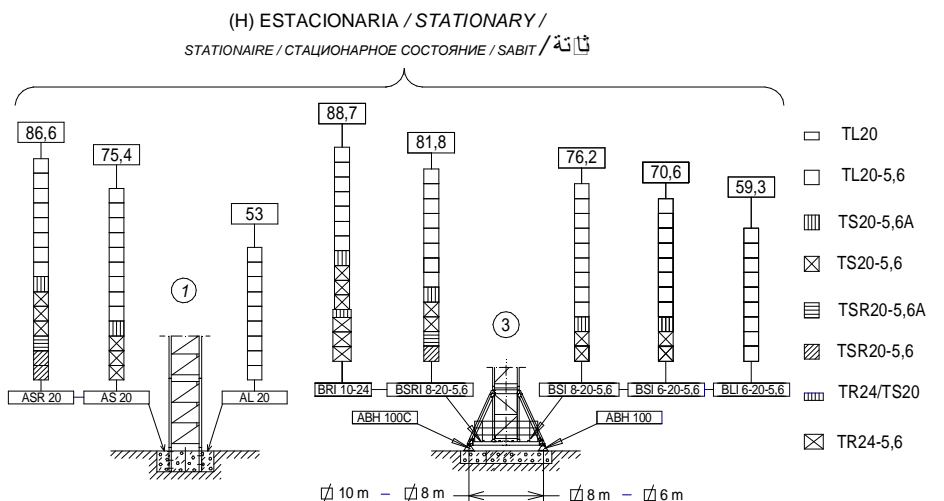

<p>Altura máxima bajo gancho sin arriostrar (m). Maximum height under hook without fastening (m). Hauteur maximale sous crochet sans ancrage (m). Максимальная высота под крюком без крепления (m). Bağlantısız maksimum kanca altı yüksekliği (m). أقصى ارتفاع تحت الخطاف دون ربط (م)</p> <p>H_{SR} =</p>	C3-17	153.50.500	BSRI 8-20-5,6	204.20.000
	C1-17	142.50.900	BRI 10-24	156.20.500
	P17-10R	153.40.500	TL20	153.31.000
	P17-2R	153.41.600	TL20-5,6	204.31.400
	P17-3N	142.42.500	TS20-5,6A	204.31.500
	P17-4N	142.43.500	TS20-5,6	204.31.200
	P17-5N	142.44.500	TSR20-5,6A	204.31.300
	P17-6N	153.45.000	TSR20-5,6	204.31.000
	P17-7N	153.46.000	TR24/TS20	156.36.800
	P17-8N	142.46.500	TR24-5,6	156.30.700
	P17-9N	142.48.500	TRD24-5,6	163.31.300
	BLI 6-20-5,6	211.20.500	ABH 100	201.23.000
	BSI 8-20-5,6	211.20.000	ABH 100C	170.23.000

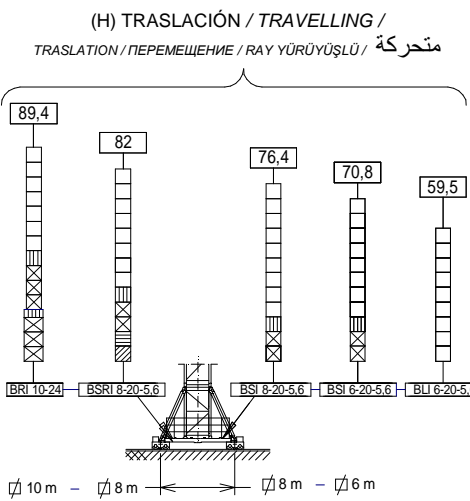











 SR (kg)		Cargas máximas / Maximum loads / Charges maximales / Максимальные нагрузки / Maksimum yük / أقصى حمولة SR - 12.000 kg											
 [m]	12000 kg @ ... (m)	Alcance del gancho [m] / Hook reach [m] / Portée du crochet (m) / Радиус действия крюка (m) / Kancanın yüksekliği (m) / مدى الخطاف											
		20	25	30	35	40	45	50	55	60	65	70	75
75 m	20,1	12000	9440	7705	6466	5536	4813	4235	3762	3368	3034	2748	2500
70 m	21,4	12000	10146	8293	6970	5978	5206	4588	4083	3662	3305	3000	—
65 m	22,4	12000	10652	8715	7331	6294	5487	4841	4313	3873	3500	—	—
60 m	23,9	12000	11438	9370	7893	6785	5923	5234	4670	4200	—	—	—
55 m	25,3	12000	12000	9975	8411	7239	6327	5597	5000	—	—	—	—
50 m	26,1	12000	12000	10313	8701	7493	6552	5800	—	—	—	—	—
45 m	27,0	12000	12000	10685	9020	7771	6800	—	—	—	—	—	—
40 m	27,0	12000	12000	10723	9053	7800	—	—	—	—	—	—	—
35 m	27,7	12000	12000	11012	9300	—	—	—	—	—	—	—	—

CARACTERISTICAS DE MECANISMOS / MECHANISMS FEATURES /

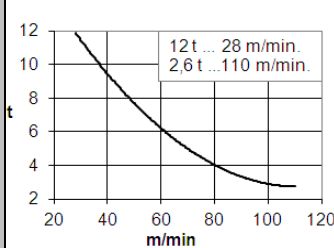
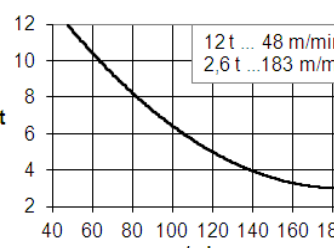
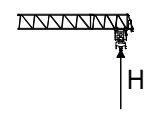
CARACTÉRISTIQUES DES MÉCANISMES / ХАРАКТЕРИСТИКИ МЕХАНИЗМОВ / MEKANİZMALARIN ÖZELLİKLERİ

الخصائص الآلية /

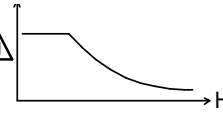
*opcional *optional *en option *опция *opsiyonel *اختياري						
	EC88110VF 65 kW	* EC150185VF 110 kW	TG2020VF 2x7,3 kW	OG2207VF 3x5,5 kW	TC7105VF 5,5 kW	TH2006 15 kW
			0...20 m/min	0...0,8 r/min sl/min	6 t 0...105 m/min 12 t 0...52 m/min	0,6 m/min
		$H \leq SR \quad 284$		 P _{TOTAL} (EC88110VF+ OG2207VF + TC7105VF) = 87 kW P _{TOTAL} (EC150185VF+ OG2207VF + TC7105VF) = 132 kW 400V 50Hz		
				  		

LASTRES INFERIORES / LOWER BALLASTS / LESTS INFÉRIEURS / НИЖНИЙ БАЛЛАСТ / ALT AĞIRLIK TAŞLARI / ثقيل

BRI 10-24	H (m)	67	78,2	89,4	
	P (t)	60	72	96	
BSRI 8-20-5,6	H (m)	57,9	65,2	82	
	P (t)	60	72	120	
BSI 8-20-5,6	H (m)	57,9	65,2	76,4	
	P (t)	60	72	96	
BSI 6-20-5,6	H (m)	31,6	42,8	59,6	70,8
	P (t)	60	72	96	120
BLI 6-20-5,6	H (m)	31,5	42,7	59,5	
	P (t)	60	72	96	

H: Altura bajo gancho / Height under hook / Hauteur maximale sous crochet / Высота под крюком / Kanca altı yüksekliği / الارتفاع أسفل الخطاف

Para alturas intermedias tomar el lastre correspondiente a la altura superior / For intermediate heights take the ballast corresponding to the higher height / Pour les hauteurs intermédiaires, opter pour le lest correspondant à la hauteur immédiatement supérieure / Для промежуточных высот возьмите балласт, соответствующий большей высоте / Orta yükseklikler için daha üst bir yüksekliğe karşılık gelen ağırlığı alınız. / للارتفاعات البينية يرجى استخدام الثقل العائد للارتفاع الأعلى / للارتفاعات البينية يرجى استخدام الثقل العائد للارتفاع الأعلى







Fecha / Date: 11/11/2021

Reservado el derecho a modificaciones sin previo aviso. Declinamos toda responsabilidad derivada de la información proporcionada / Subject to modification, without prior notice. This information is supplied without liability / L'entreprise se réserve le droit de procéder à des modifications sans préavis. Nous déclinons toute responsabilité quant aux informations fournies / Мы оставляем за собой право на внесение изменений без предварительного уведомления. Мы снимаем с себя любую ответственность в отношении предоставленной информации / Önceden bildirilmeksizin değiştirime hakkı saklıdır. Verilen bilgiler için hiçbir sorumluluk kabul etmemekteyiz / حقوق التغيير محفوظة دون إشعار مسبق. دون أدنى مسؤولية عن المعلومات المقدمة

LISTA DE EMBARQUE / PACKING LIST

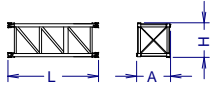
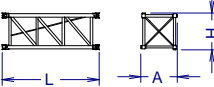
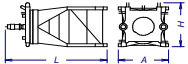
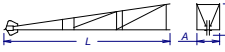
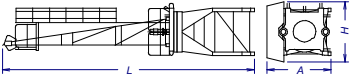
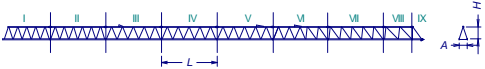
J300N.2R.A

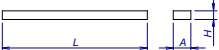
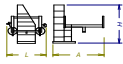
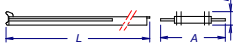
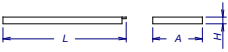
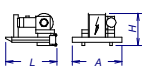
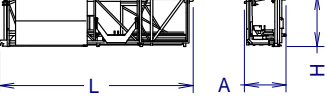
LISTE DE COLISAGE / СПИСОК ПОСТАВКИ / ÇEKİ LİSTESİ / قائمة التحميل

DENOMINACIÓN / DENOMINATION / DÉSIGNATION / НАЗВАНИЕ / AÇIKLAMA / اسم		L [m]	A [m]	H [m]	P / W [kg]	
Torre inferior / Lower tower / Tour inférieure / Нижняя башня Alt kule / البرج السفلي	TLI20-5,6		5,886	2,306	2,357	4235
	TSI20-5,6		5,966	2,328	2,390	5390
	TSRI20-5,6		5,990	2,257	2,257	6562
	TRID24-5,6		5,990	3,202	3,202	8400
Torre / Tower / Tour Башня / Kule / برج	TL20		4,175	2,201	2,281	2095
	TL20-5,6		5,886	2,306	2,357	2910
	TS20-5,6A		5,978	2,381	2,331	3530
	TS20-5,6		5,966	2,328	2,390	3550
	TSR20-5,6A		5,926	2,388	2,325	4170
	TSR20-5,6		5,990	2,257	2,257	4210
	TR24-5,6		5,990	2,760	2,835	4760
TRD24-5,6	5,977	2,740	2,285	5280		
Torre asiento pista + base punta de torre + orientación Slewling table + tower head base + slewing mechanism Tour pivot + base du porte-flèche + mécanisme d'orientation Сиденье площадки + основание верхней секции башни + поворотный механизм Göbek + kule kafa bölümü tabanı+mekanizma برج وحدة الدوارن + قاعدة رأس البرج + آلية الدوارن			5,08	2,53	2,27	7390
Punta de torre / Tower head / Porte-flèche верхняя секция башни / kulinin kafa bölümü / رأس البرج			8,19	1,41	1,82	2820
Conjunto asiento pista, punta de torre, orientación Slewling table assembl +, tower head + slewing Groupe pivot + porte-flèche + mécanisme d'orientation Сиденье площадки + верхняя секция башни + поворотный механизм Göbek + kulinin kafa bölümü+mekanizma مجموعة وحدة الدوارن + رأس البرج + آلية الدوارن			12,15	3,05	2,48	10750
Tramo de pluma Jib section Tronçon de flèche Секция стрелы Vom bölümü أجزاء الذراع	P17-10R (1)		8,81	1,68	1,99	1740
	P17-2R (2)		10,19	1,60	2,03	2050
	P17-3N (3)		10,19	1,60	2,04	1970
	P17-4N (4)		10,19	1,60	1,89	1680
	P17-5N (5)		10,19	1,60	1,99	1530
	P17-6R (6)		10,19	1,60	1,99	1485
	P17-7N (7)		10,19	1,60	1,89	1165
	P17-8N (8)		5,30	1,60	1,89	745
	P17-9N (9)		2,16	1,60	2,20	420
Polipasto / Hook assembly / Palan / Полупаст / Kanca takımı / بكرة			1,35	0,3	1,3	400
Tirante sostén pluma / Jib support tie / Tirant de fleche / Растяжка поддержки стрелы / Kol destek bağları / مشد دعامة الذراع	Largo / Long Corto / Short		4,97	0,40	0,74	1605
			6,02	0,22	0,71	870
Carro / Trolley / Chariot / Грузовая тележка / Şaryo / عربة			2,32	2,42	1,55	570
Contra-pluma con plataformas / Counterjib with platforms Contre-flèche avec plateformes / Противовесная консоль с платформами / Platformlu kuuyuk / الذراع المقابل مع المنصة			12,10	2,76	0,62	3085
Prolongación contra-pluma con plataforma / Counterjib extension with platform Prolongement contre-flèche avec plateforme / Удлинение противовесной консоли с платформой / Kuuyuk platformla uzatılması / امتداد الذراع المعاكس مع الممرات			8,30	1,91	0,58	1925
Plataforma y cabina / Platform and cabin / Plateforme et cabine Платформа и кабина / Platform ve kabin / منصة وكابينة			3,760	2,050	2,400	1280
Soporte y elevación (sin cable) / Support and hoisting (without rope) / Support et levage (sans câble) / Опора и подъем (без троса) / Destek ve vinç kulesi (kablesuz) / دعم ورفع (بدون كابل)		EC 88110 VF 	3,03	2,3	2,12	3900
Transporte torre de montaje/ Jacking cage transport / Transport de tour de montage / Транспортировка монтажной башни / Kaldırma kafesinin taşınması / نقل برج التركيب			9.550	2.070	2.520	5.690
Lastre / Ballast / Lest / Балласт / Alt ağırlik taşları / ثقل			3,80	0,58	1,5	6000

Fecha / Date: 11/11/2021

 **FEM 1001**



Reservado el derecho a modificaciones sin previo aviso. Declinamos toda responsabilidad derivada de la información proporcionada / Subject to modification, without prior notice. This information is supplied without liability / L'entreprise se réserve le droit de procéder à des modifications sans préavis. Nous déclinons toute responsabilité quant aux informations fournies / Мы оставляем за собой право на внесение изменений без предварительного уведомления. Мы снимаем с себя любую ответственность в отношении предоставленной информации / Önceden bildirilmeksizin değiştirime hakkı saklıdır. Verilen bilgiler için hiçbir sorumluluk kabul etmemekteyiz / حقوق التغيير محفوظة دون إشعار مسبق. دون أدنى مسؤولية عن المعلومات المقدمة

COMPOSICIONES DE TORRE / TOWER COMPOSITIONS

COMPOSITIONS DE LA TOUR / КОНСТРУКЦИЯ БАШНИ / KULE KOMPOZİSYONLARI / مكونات البرج

J300N.2R.A

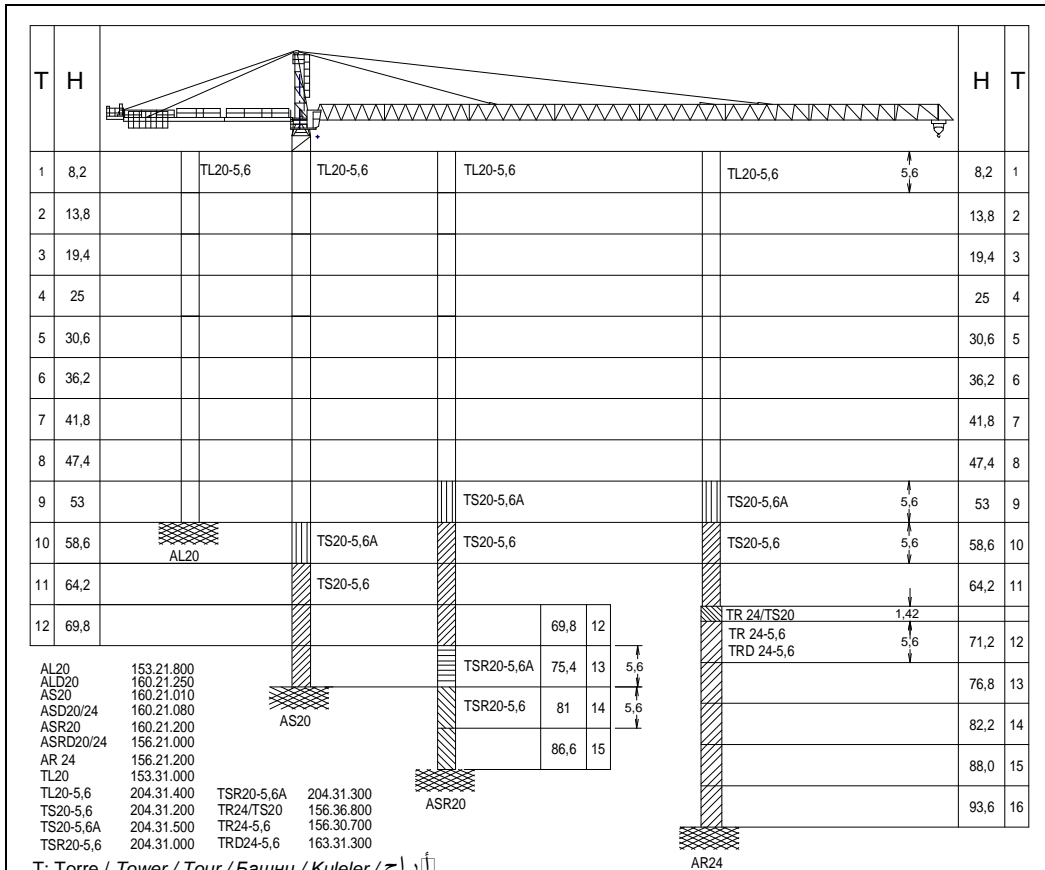

Transporte
Transport / Transport /
Транспортировка / Taşıma / نقل

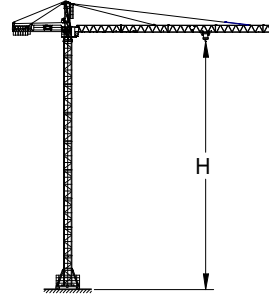

H=59,3 m + + BLI 6-20-5,6



11x HIGH CUBE 40'

i Otras configuraciones de torre / Other tower configuration / Autres configurations / Прочие конфигурации / Diğer konfigürasyonlar / مكونات أخرى

TREPADO / CLIMBING / TÉLESCOPAGE / ЛЕСТНИЦА / TIRMANMA / التسلق

J300N.2R.A

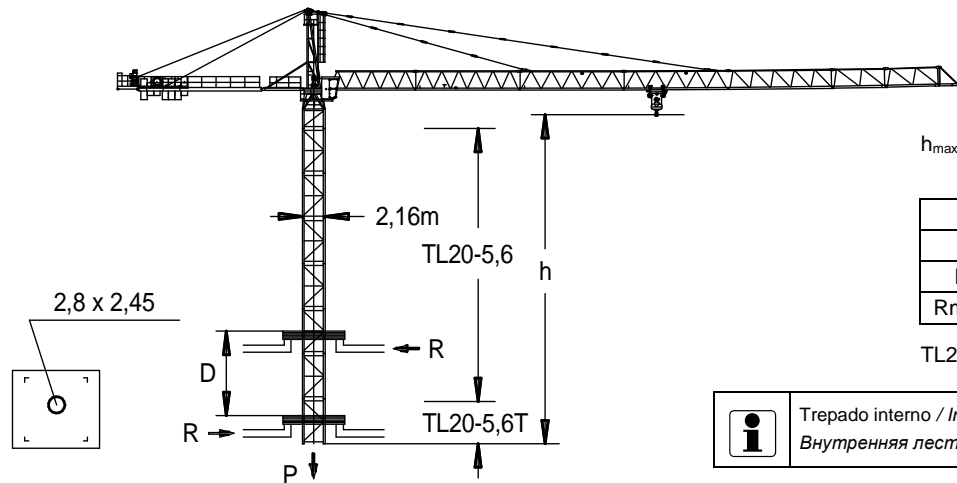

$h_{max} = TL20-5,6T + 6 \times TL20-5,6 + 2 \times TL20$

	▶	■
h (m)	49,6	
D (m)	10 - 20	
P (KN)	1132	1012
Rmax (KN)	288	443

TL20-5,6T = 136.32.700

i Trepado interno / Internal climbing. / Télescopage intérieur / Внутренняя лестница / Bina içi tırmanma / التسلق الداخلي

Viento fuera de servicio / Out of service wind / Vitesse du vent hors service / Ветровая нагрузка в покое / Rüzgar devre dışı / الريح خارج الخدمة

- i** Consultar / Consult / Nous consulter / Консультируйтесь / Danışınız / الرجوع إلى
- ▶ En servicio / In service / En service / В работе / Devrede / في الخدمة
- Fuera de servicio / Out of service / Hors service / В покое / Devre dışı / خارج الخدمة



Ctra./Rd. Madrid - Irún Km. 415 - 20.213 IDIAZABAL [Gipuzkoa] ESPAÑA / SPAIN
P.O. Box, 23 - 20.200 BEASAIN - E-mail: jaso@jaso.com
Tel. +34 943 - 18 70 00 • Fax. +34 943 - 18 70 20
www.jaso.com

Fecha / Date: 11/11/2021

FEM 1001

DELEGACION / DEALER

Reservado el derecho a modificaciones sin previo aviso. Declinamos toda responsabilidad derivada de la información proporcionada / Subject to modification, without prior notice. This information is supplied without liability / L'entreprise se réserve le droit de procéder à des modifications sans préavis. Nous déclinons toute responsabilité quant aux informations fournies / Мы оставляем за собой право на внесение изменений без предварительного уведомления. Мы снимаем с себя любую ответственность в отношении предоставленной информации / Önceden bildirilmeksizin değiştirilme hakkı saklıdır. Verilen bilgiler için hiçbir sorumluluk kabul etmemekteyiz / حقوق التغيير محفوظة دون إشعار مسبق. دون أدنى مسؤولية عن المعلومات المقدمة