

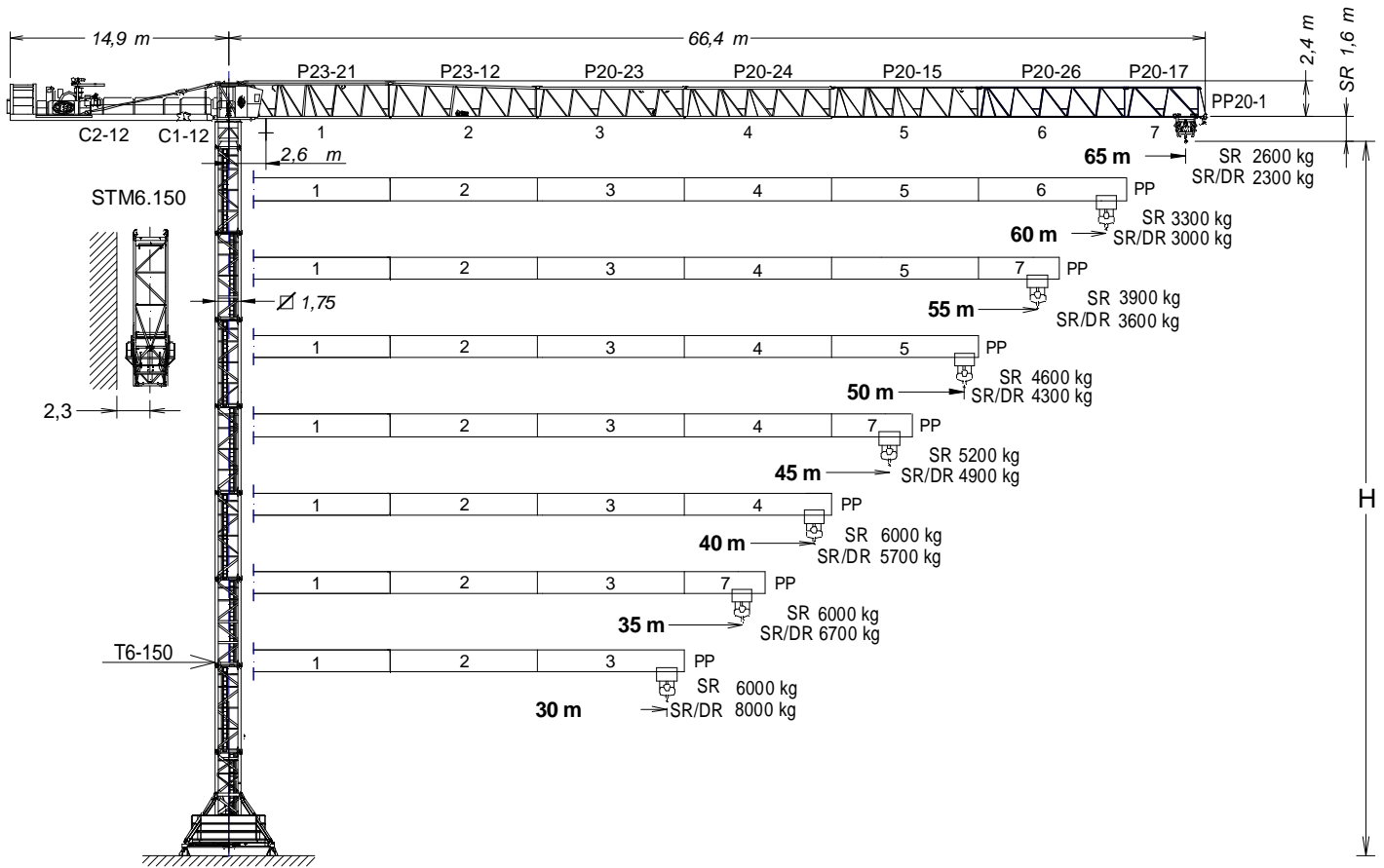

EN 14439
C25

UNE-EN-ISO 9001



C2-12	171.50.200	P20-24	171.43.200	T3-150	161.32.000	AN 150	161.21.000
C1-12	171.50.050	P20-15	171.44.000	T6-150	161.31.000	BNI 45-150	161.20.500
P23-21	171.40.600	P20-26	171.45.200	TD6-150	161.31.700	BNI 6-150	161.20.000
P23-12	171.41.000	P20-17	171.46.000	T12-150	161.31.500	ABH 100	201.23.000
P20-23	171.42.300	PP20-1	171.47.000				

Fecha / Date: 11/10/2022



FEM 1005 - C25



Reservado el derecho a modificaciones sin previo aviso. Declinamos toda responsabilidad derivada de la información proporcionada / Subject to modification, without prior notice. This information is supplied without liability / L'entreprise se réserve le droit de procéder à des modifications sans préavis. Nous déclinons toute responsabilité quant aux informations fournies / Das Recht auf Änderungen ohne vorherige Ankündigung bleibt vorbehalten. Wir übernehmen keine Gewähr für die gemachten Angaben / Мы оставляем за собой право на внесение изменений без предварительного уведомления. Мы снимаем с себя любую ответственность в отношении предоставленной информации / حقوق التغيير محفوظة دون إشعار مسبق. دون أدنى مسؤولية عن المعلومات المقدمة

(H_{SR}) ESTACIONARIA 1 / STATIONARY 1 / STATIONAIRE 1 / STATIONÄR 1 / СТАЦИОНАРНОЕ СОСТОЯНИЕ / ثابتة

▽△	H(m)	☒	☒
65 - 30	47,2	8	-

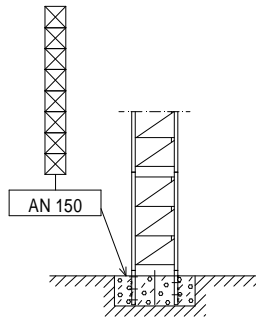

- ☒ T3-150
- ☒ T6-150
TD6-150
- ☒ T12-150

(H_{SR}) ESTACIONARIA 3 / STATIONARY 3 / STATIONAIRE 3 / STATIONÄR 3 / СТАЦИОНАРНОЕ СОСТОЯНИЕ / ثابتة

▽△	H(m)	☒	☒
65 - 60	42,3	6	-
55 - 40	39,4	5	1
35 - 30	42,3	6	-

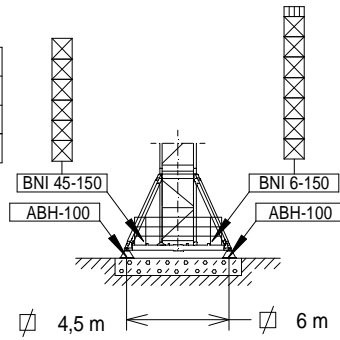

▽△	H(m)	☒	☒
65 - 30	51,0	7	1

- ☒ T3-150
- ☒ T6-150
TD6-150
- ☒ T12-150

(H_{SR}) TRASLACIÓN / TRAVELLING / TRASLATION / FORTBEWEGUNG / ПЕРЕМЕЩЕНИЕ / متحركة

▽△	H(m)	☒	☒
65 - 60	42,5	6	-
55 - 40	39,6	5	1
35 - 30	42,5	6	-

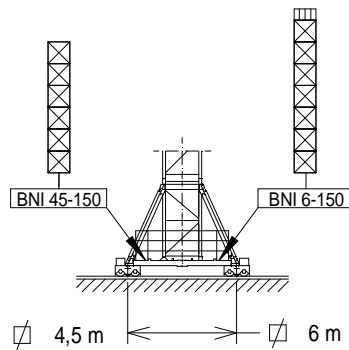

▽△	H(m)	☒	☒
65 - 30	51,2	7	1

- ☒ T3-150
- ☒ T6-150
TD6-150
- ☒ T12-150

H_{SR} =







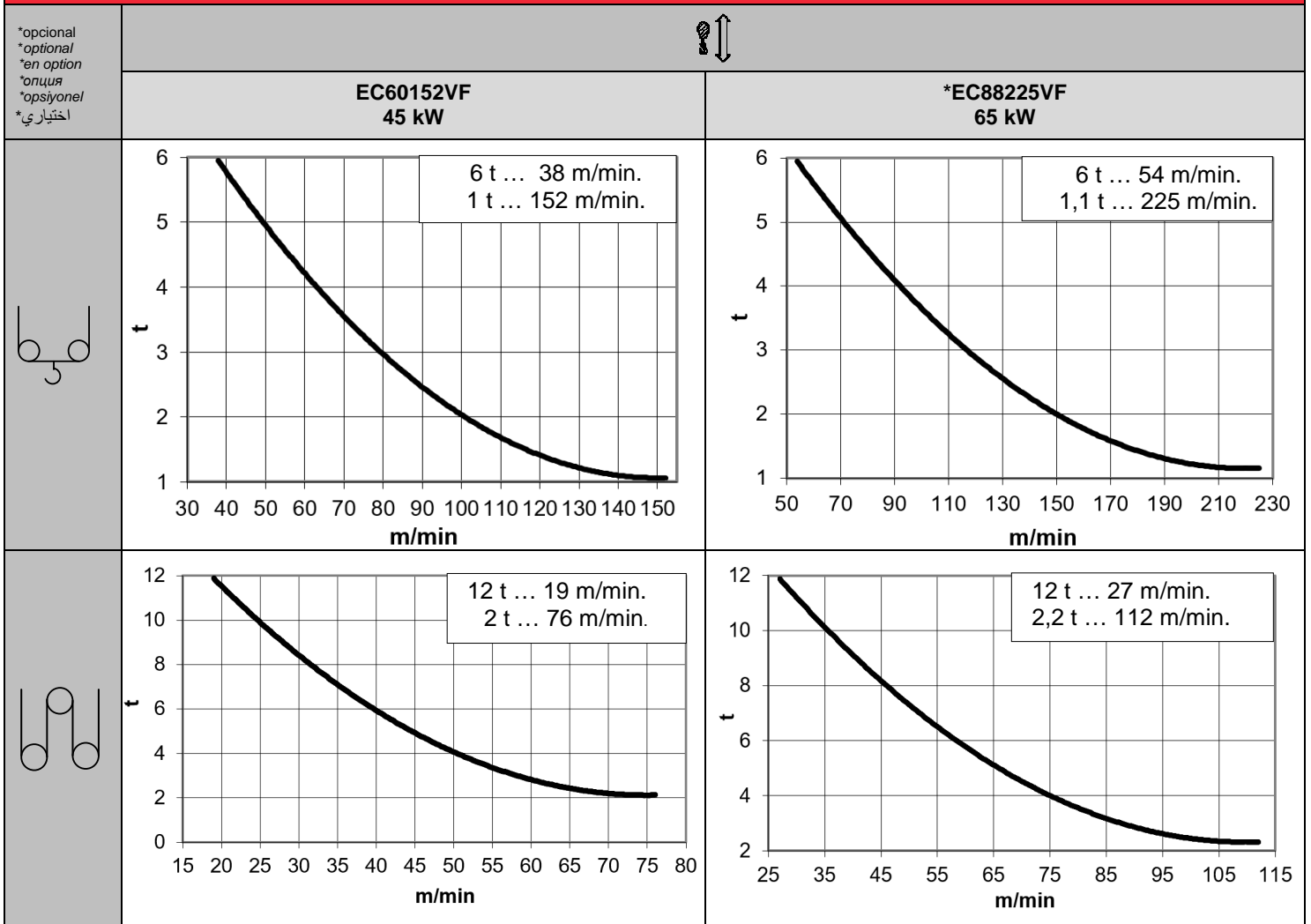

Altura máxima bajo gancho sin arriostrar (m).
 Maximum height under hook without fastening (m).
 Hauteur maximale sous crochet sans ancrage (m).
 Max. Hakenhöhe ohne Verstreben (m).
 Максимальная высота под крюком без крепления (m).
 أقصى ارتفاع تحت الخطاف بدون ربط (m)

H_{SR/DR} = H_{SR} - 0,5

b_3d SR (t)		Cargas máximas / Maximum loads / Charges maximales / Höchstlasten / Максимальные нагрузки / أقصى حمولة SR – 6 t									
 [m]	6 t @ ... (m)	Alcance del gancho [m] / Hook reach [m] Portée du crochet (m) / Reichweite des Hakens (m) / Радиус действия крюка (m) / مدى الخطاف									
		25	30	35	40	45	50	55	60	65	
65,0	31,3	6	6	5,30	4,57	4,00	3,55	3,17	2,86	2,60	
60,0	35,3	6	6	6	5,23	4,58	4,07	3,65	3,30	—	
55,0	37,4	6	6	6	5,57	4,89	4,35	3,90	—	—	
50,0	39,3	6	6	6	5,89	5,17	4,60	—	—	—	
45,0	39,5	6	6	6	5,92	5,20	—	—	—	—	
40,0	40,0	6	6	6	6	—	—	—	—	—	
35,0	35,0	6	6	6	—	—	—	—	—	—	
30,0	30,0	6	6	—	—	—	—	—	—	—	

b_3d/b_3b SR - DR (t)		Cargas máximas / Maximum loads / Charges maximales / Höchstlasten / Максимальные нагрузки / أقصى حمولة SR / DR – 6 / 12 t										
 [m]	6 - 12 t @ ... (m)	Alcance del gancho [m] / Hook reach [m] Portée du crochet (m) / Reichweite des Hakens (m) / Радиус действия крюка (m) / مدى الخطاف										
		15	20	25	30	35	40	45	50	55	60	65
65,0	29,6 - 15,7	6 – 12	6 – 9,25	6 – 7,24	6 – 5,91	4,95	4,26	3,67	3,23	2,86	2,56	2,30
60,0	33,5 - 17,8	6 – 12	6 – 10,58	6 – 8,31	6 – 6,79	5,71	4,90	4,26	3,76	3,34	3,00	—
55,0	35,6 - 18,9	6 – 12	6 – 11,28	6 – 8,87	6 – 7,26	6 – 6,11	5,25	4,58	4,04	3,60	—	—
50,0	37,5 - 19,9	6 – 12	6 – 11,94	6 – 9,39	6 – 7,69	6 – 6,48	5,57	4,87	4,30	—	—	—
45,0	37,7 - 20,0	6 – 12	6 – 12	6 – 9,45	6 – 7,75	6 – 6,53	5,61	4,90	—	—	—	—
40,0	38,2 - 20,3	6 – 12	6 – 12	6 – 9,59	6 – 7,86	6 – 6,63	5,70	—	—	—	—	—
35,0	35,0 - 20,5	6 – 12	6 – 12	6 – 9,70	6 – 7,95	6 – 6,70	—	—	—	—	—	—
30,0	30,0 - 20,6	6 – 12	6 – 12	6 – 9,76	6 – 8	—	—	—	—	—	—	—

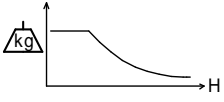
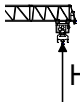

				 400V 50Hz	 				
OG2208VF 3 x 5,5 kW	TC770VF 5,5 kW	TG2020VF 2x7,3 kW	TH1506 11 kW	P _{TOTAL} (EC60152VF + OG2208VF + TC770VF) = 67 kW P _{TOTAL} (EC88225VF + OG2208VF + TC770VF) = 87 kW					
0...0,8 r/min sl/min	6 t 0...70 m/min 12 t 0...35 m/min	0...20 m/min	1 m/min	 $H \leq$ <table style="display: inline-table; vertical-align: middle;"> <tr> <td>SR</td> <td>534 m</td> </tr> <tr> <td>DR</td> <td>267 m</td> </tr> </table>	SR	534 m	DR	267 m	 ecoMode
SR	534 m								
DR	267 m								
				 1378 m					



Fecha / Date: 11/10/2022

 **FEM 1005 - C25**

Reservado el derecho a modificaciones sin previo aviso. Declinamos toda responsabilidad derivada de la información proporcionada / Subject to modification, without prior notice. This information is supplied without liability / L'entreprise se réserve le droit de procéder à des modifications sans préavis. Nous déclinons toute responsabilité quant aux informations fournies / Das Recht auf Änderungen ohne vorherige Ankündigung bleibt vorbehalten. Wir übernehmen keine Gewähr für die gemachten Angaben / Мы оставляем за собой право на внесение изменений без предварительного уведомления. Мы снимаем с себя любую ответственность в отношении предоставленной информации / محفوظة دون إشعار مسبق. دون أدنى مسؤولية عن المعلومات المقدمة

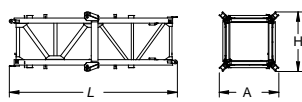
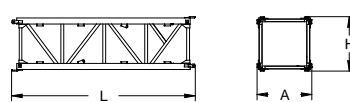
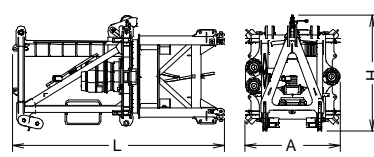
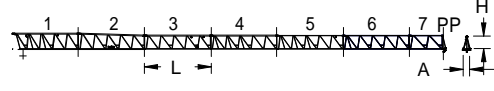
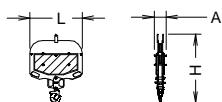
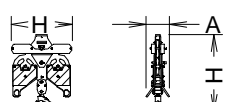
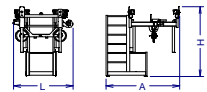
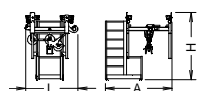
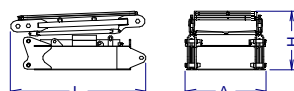
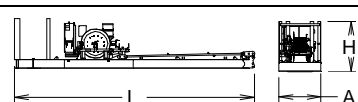
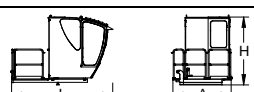
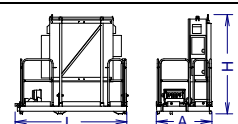
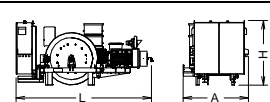
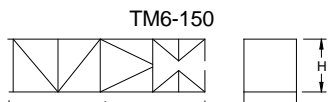
DENOMINACIÓN / DENOMINATION / DÉSIGNATION / BEZEICHNUNG / НАЗВАНИЕ / اسم		L [m]	A [m]	H [m]	P / W [kg]
Torre inferior / Lower tower Tour inférieure / Unterer Turm Нижняя башня / البرج السفلي البرج السفلي	TI-6-150				
		6,175	2,190	2,190	3535
Torre / Tower Tour / Turm Башня / برج	T6-150 TD6-150 T3-150 T12-150				
		6,175	1,870	1,870	2760
		6,175	1,870	1,870	2930
		3,265	1,870	1,870	1550
		12,000	1,870	1,870	5180
Torre asiento pista + punta de torre + orientación Slewing table + tower head + slewing mechanism Tour pivot + porte-flèche + mécanisme d'orientation Turmsitz + Turmspitze + Ausrichtung Сиденье площадки + верхней секции башни +поворотный механизм رج وحدة الدوارن + رأس البرج + آلية الدوران					
		4,630	2,080	2,490	6900
Tramo de pluma Jib section Tronçon de flèche Auslegerabschnitt Секция стрелы أجزاء الذراع	P23-21 P23-12+tr P20-23 P20-24 P20-15 P20-26 P20-17 PP20-1				
		10,280	1,356	2,495	2600
		10,280	1,126	2,475	2570
		10,235	1,126	2,215	1690
		10,190	1,126	2,195	1205
		10,190	1,126	2,155	815
		10,190	1,126	2,215	585
		5,180	1,126	2,215	350
		0,890	1,290	2,500	130
Polipasto / Hook assembly Palan / Flaschenzug / Полиспаст / ككرة	SR - 6 t				
		0,860	0,200	1,126	220
	SR/DR - 12 t				
		1,020	0,390	1,324	390
Carro / Trolley Chariot / Laufkatze Грузовая тележка / عربة	SR - 6 t				
		1,560	1,935	1,891	320
	SR/DR - 12 t				
		1,753	1,960	1,860	400
Contrapluma / Counterjib / Contre-flèche Gegenausleger / Противовесная консоль / الذراع المعاكس	C1-12				
		2,398	1,430	1,100	1080
Contrapluma + Elevación / Counterjib + Hoisting/ Contre-flèche + Levage Gegenausleger + Hebewerk / Противовесная консоль / الذراع المعاكس	C2-12				
		11,982	2,106	2,500	9245
Plataforma y cabina / Platform and cabin Plateforme et cabine / Plattform + Führerstand Платформа и кабина / منصة وكابينة					
		3,520	2,060	2,400	1120
Armario eléctrico y plataforma Electrical cabinet and platform armoire électrique et plateforme Stromkasten + Plattform					
		2,655	1,317	2,339	821
Soporte y elevación (sin cable) / Support and hoisting (without rope) / Support et levage (sans câble) Abstützung und Hebewerk (ohne Seil) Опора и подъем (без троса) / دعم ورفع (بدون كابل)					
		3,800	1,840	1,840	3710
Estructura torre de montaje Jacking cage structure Structure de tour de montage Stromkasten + Plattform	TM6-150				
		10,320	2,420	2,310	3500



Fecha / Date: 11/10/2022

 **FEM 1005 - C25**

Reservado el derecho a modificaciones sin previo aviso. Declinamos toda responsabilidad derivada de la información proporcionada / Subject to modification, without prior notice. This information is supplied without liability / L'entreprise se réserve le droit de procéder à des modifications sans préavis. Nous déclinons toute responsabilité quant aux informations fournies / Das Recht auf Änderungen ohne vorherige Ankündigung bleibt vorbehalten. Wir übernehmen keine Gewähr für die gemachten Angaben / Мы оставляем за собой право на внесение изменений без предварительного уведомления. Мы снимаем с себя любую ответственность в отношении предоставленной информации / حقوق التغيير محفوظة دون إشعار مسبق دون أدنى مسؤولية عن المعلومات المقدمة

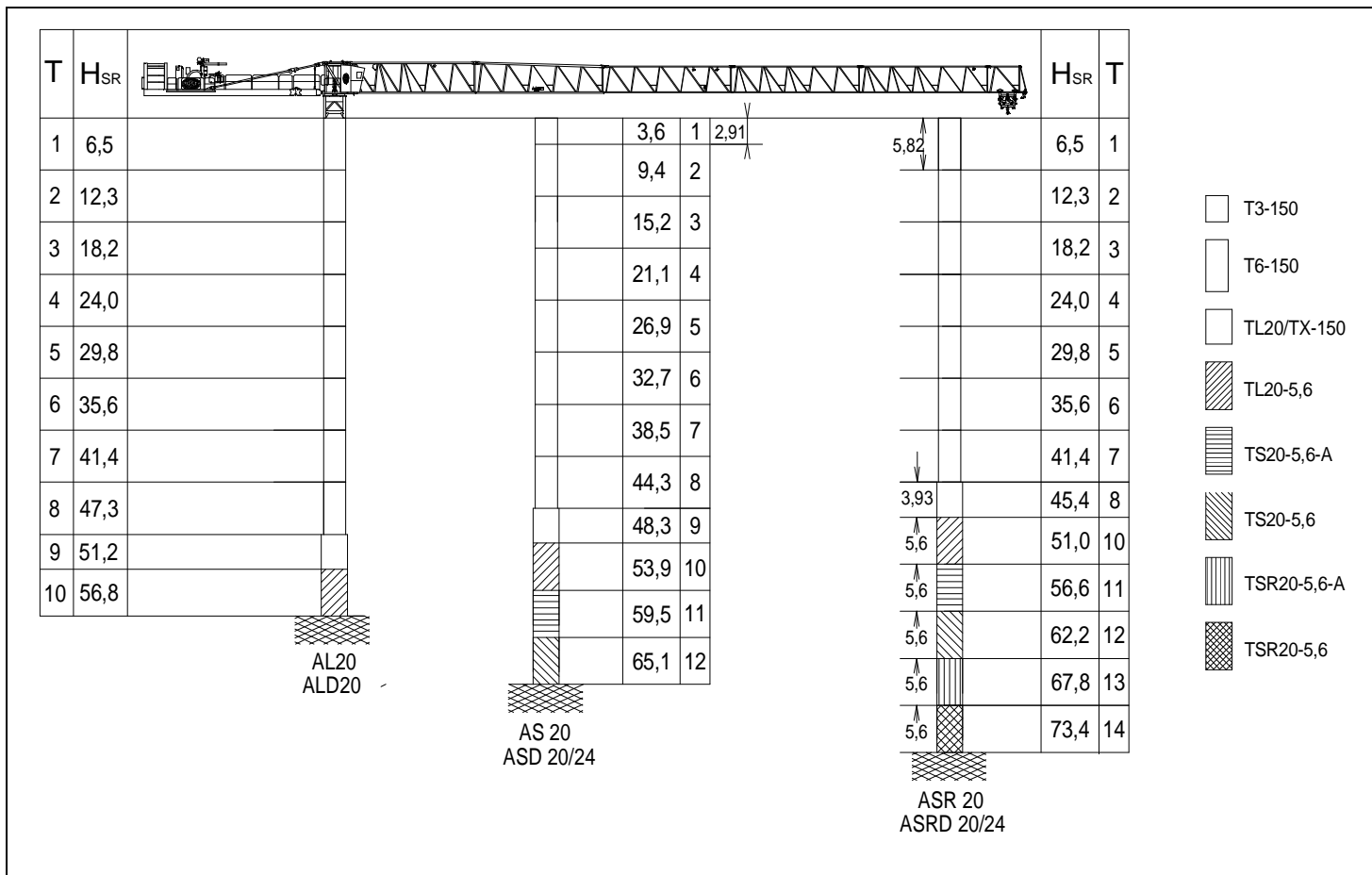

T: Torre / Tower / Tour / Turm / Башни / أبراج / ارتفاع	H _{SR/DR} = H _{SR} - 0,5	TL20/TX-150----- 161.36.000 TL20-5,6 ----- 204.31.400 TS20-5,6A----- 204.31.500 TS20-5,6 ----- 204.31.200 TSR20-5,6A----- 206.31.300 TSR20-5,6----- 206.31.000	AL 20----- 153.21.800 ALD 20 ----- 160.21.250 AS 20 ----- 160.21.010 ASD 20/24----- 160.21.080 ASR 20 ----- 160.21.200 ASRD 20/24----- 156.21.000
---	--	---	--

Otras configuraciones de torre / Other tower configuration / Autres configurations / Andere turmkonfigurationen / Прочие конфигурации / مكونات أخرى

TRANSPORTE / TRANSPORT / TRANSPORT / TRANSPORT / ТРАНСПОРТИРОВКА / نقل J235.12

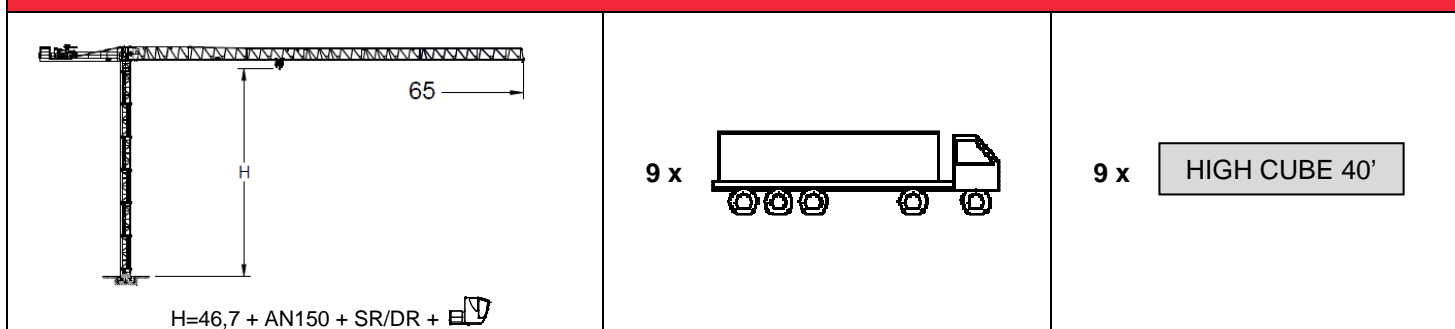

- ⚠ Viento fuera de servicio / Out of service wind / Vitesse du vent hors service / Wind außer betrieb / Ветровая нагрузка в покое / الريح خارج الخدمة
- ℹ Consultar / Consult / Nous consulter / Anfragen / Консультируйтесь / الرجوع إلى
- ▶ En servicio / In service / En service / In betrieb / В работе / في الخدمة
- Fuera de servicio / Out of service / Hors service / Außer betrieb / В покое / خارج الخدمة



Ctra./Rd. Madrid - Irún Km. 415 - 20.213 IDIAZABAL [Gipuzkoa] ESPAÑA / SPAIN
 P.O. Box, 23 - 20.200 BEASAIN - E-mail: jaso@jaso.com
 Tel. +34 943 - 18 70 00 • Fax. +34 943 - 18 70 20
www.jaso.com

Fecha / Date: 11/10/2022

FEM 1005 - C25

DELEGACION / DEALER

Reservado el derecho a modificaciones sin previo aviso. Declinamos toda responsabilidad derivada de la información proporcionada / Subject to modification, without prior notice. This information is supplied without liability / L'entreprise se réserve le droit de procéder à des modifications sans préavis. Nous déclinons toute responsabilité quant aux informations fournies / Das Recht auf Änderungen ohne vorherige Ankündigung bleibt vorbehalten. Wir übernehmen keine Gewähr für die gemachten Angaben / Мы оставляем за собой право на внесение изменений без предварительного уведомления. Мы снимаем с себя любую ответственность в отношении предоставленной информации / حقوق التغيير محفوظة دون إشعار مسبق. دون أدنى مسؤولية عن المعلومات المقدمة