

| | | | | | | | |
|--------|------------|--------|------------|---------|------------|------------|------------|
| C2-12 | 171.50.200 | P20-14 | 171.43.000 | PP20-1 | 171.47.000 | AN 150 | 161.21.000 |
| C1-12 | 171.50.050 | P20-15 | 171.44.000 | T3-150 | 161.32.000 | BNI 45-150 | 161.20.500 |
| P23-11 | 171.40.000 | P20-16 | 171.45.000 | T6-150 | 161.31.000 | BNI 6-150 | 161.20.000 |
| P23-12 | 171.41.000 | P20-17 | 171.46.000 | TD6-150 | 161.31.700 | ABH 100 | 201.23.000 |
| P20-13 | 171.42.000 | P20-18 | 171.46.500 | T12-150 | 161.31.500 | | |

SR

(H_{SR}) ESTACIONARIA 1 / STATIONARY 1

| ▽▽ | H(ft) | ☒ | ☐ |
|-----------|-------|---|---|
| 221 - 213 | 174 | 9 | - |
| 205 - 98 | 184 | 9 | 1 |

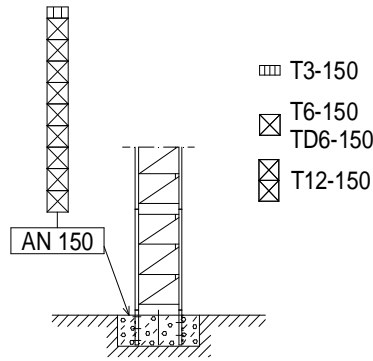

(H_{SR}) ESTACIONARIA 3 / STATIONARY 3

| ▽▽ | H(ft) | ☒ | ☐ |
|-----------|-------|---|---|
| 221 - 189 | 158 | 7 | - |
| 180 - 139 | 167 | 7 | 1 |
| 131 - 98 | 158 | 7 | - |

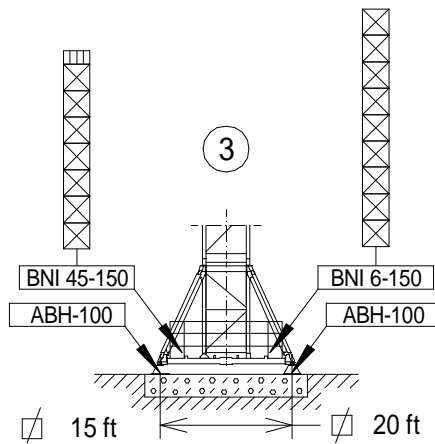

| ▽▽ | H(ft) | ☒ | ☐ |
|-----------|-------|---|---|
| 221 - 189 | 187 | 8 | 1 |
| 180 - 115 | 196 | 9 | - |
| 107 - 98 | 187 | 8 | 1 |

- ☐ T3-150
- ☒ T6-150
- TD6-150
- ☒ T12-150

(H_{SR}) TRASLACIÓN / TRAVELLING

| ▽▽ | H(ft) | ☒ | ☐ |
|-----------|-------|---|---|
| 221 - 139 | 159 | 7 | - |
| 131 - 107 | 149 | 6 | 1 |
| 98 | 159 | 7 | - |

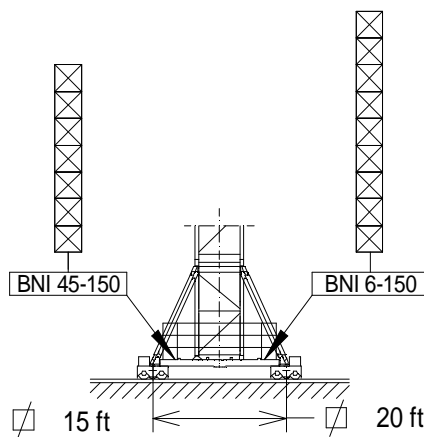



| ▽▽ | H(ft) | ☒ | ☐ |
|-----------|-------|---|---|
| 221 - 189 | 187 | 8 | 1 |
| 180 - 115 | 197 | 9 | - |
| 107 - 98 | 187 | 8 | 1 |

- ☐ T3-150
- ☒ T6-150
- TD6-150
- ☒ T12-150





H= Altura máxima bajo gancho sin arristrar (m).
Maximum height under hook without fastening (m).

ST-DR

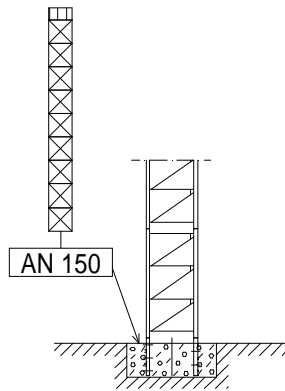

(H_{ST-DR}) ESTACIONARIA 1 / STATIONARY 1

|  | H(ft) |  |  |
|-----------------------------------------------------------------------------------|-------|-----------------------------------------------------------------------------------|-----------------------------------------------------------------------------------|
| 221 - 131 | 173 | 9 | - |
| 123 - 98 | 182 | 9 | 1 |







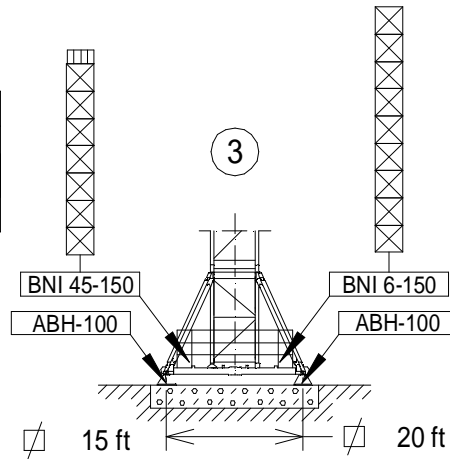

-  T3-150
-  T6-150
-  TD6-150
-  T12-150

(H_{ST-DR}) ESTACIONARIA 3 / STATIONARY 3



|  | H(ft) |  |  |
|-----------------------------------------------------------------------------------|-------|-----------------------------------------------------------------------------------|-----------------------------------------------------------------------------------|
| 221 - 189 | 157 | 7 | - |
| 180 - 139 | 166 | 7 | 1 |
| 131 - 98 | 157 | 7 | - |







|  | H(ft) |  |  |
|-------------------------------------------------------------------------------------|-------|-------------------------------------------------------------------------------------|-------------------------------------------------------------------------------------|
| 221 - 131 | 186 | 8 | 1 |
| 123 - 98 | 195 | 9 | - |



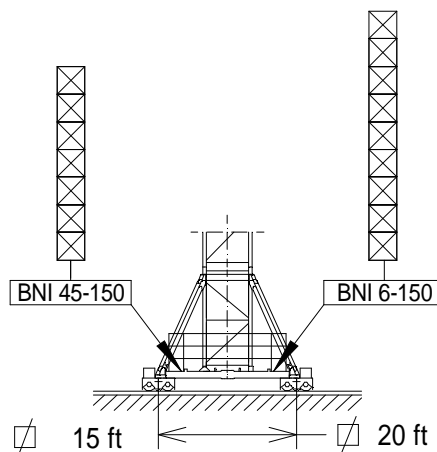

-  T3-150
-  T6-150
-  TD6-150
-  T12-150

(H_{ST-DR}) TRASLACIÓN / TRAVELLING

|  | H(ft) |  |  |
|-------------------------------------------------------------------------------------|-------|-------------------------------------------------------------------------------------|-------------------------------------------------------------------------------------|
| 221 - 139 | 157 | 7 | - |
| 131 - 98 | 148 | 6 | 1 |





|  | H(ft) |  |  |
|---------------------------------------------------------------------------------------|-------|---------------------------------------------------------------------------------------|---------------------------------------------------------------------------------------|
| 221 - 131 | 186 | 8 | 1 |
| 123 - 98 | 196 | 9 | - |

-  T3-150
-  T6-150
-  TD6-150
-  T12-150

H = *Altura máxima bajo gancho sin arriostrar (m).*
Maximum height under hook without fastening (m).

$H_{ST-SR} = H_{ST-DR}$

|  SR (lb) | | Cargas máximas / Maximum loads | | | | | | | | | | | | | | | | | | | |
|----------------------------------------------------------------------------------------------------|-----|-------------------------------------------|-------|-------|-------|-------|-------|-------|-------|-------|-------|------|------|------|------|------|------|------|------|------|------|
| | | SR – 13200 lb | | | | | | | | | | | | | | | | | | | |
|  13200 lb @...(ft) | | Alcance del gancho [ft] / Hook reach [ft] | | | | | | | | | | | | | | | | | | | |
| | | 33 | 49 | 66 | 82 | 98 | 107 | 115 | 123 | 131 | 139 | 148 | 156 | 164 | 172 | 180 | 189 | 197 | 205 | 213 | 221 |
| 221 | 79 | 13200 | 13200 | 13200 | 12800 | 10400 | 9500 | 8800 | 8200 | 7500 | 7100 | 6600 | 6200 | 5700 | 5511 | 5100 | 4900 | 4600 | 4400 | 5100 | 4000 |
| 213 | 86 | 13200 | 13200 | 13200 | 13200 | 11500 | 10600 | 9700 | 8800 | 8400 | 7700 | 7300 | 6800 | 6400 | 6000 | 5700 | 5300 | 5100 | 4900 | 4600 | — |
| 205 | 89 | 13200 | 13200 | 13200 | 13200 | 11900 | 10800 | 9900 | 9300 | 8600 | 7900 | 7500 | 7000 | 6600 | 6200 | 6000 | 5500 | 5300 | 5100 | — | — |
| 197 | 92 | 13200 | 13200 | 13200 | 13200 | 12300 | 11200 | 10400 | 9500 | 8800 | 8400 | 7700 | 7300 | 6800 | 6400 | 6200 | 5700 | 5500 | — | — | — |
| 189 | 94 | 13200 | 13200 | 13200 | 13200 | 12600 | 11500 | 10600 | 9700 | 9000 | 8400 | 7900 | 7500 | 7100 | 6600 | 6200 | 6000 | — | — | — | — |
| 180 | 98 | 13200 | 13200 | 13200 | 13200 | 13200 | 12100 | 11000 | 10400 | 9500 | 8800 | 8400 | 7900 | 7500 | 7100 | 6600 | — | — | — | — | — |
| 172 | 101 | 13200 | 13200 | 13200 | 13200 | 13200 | 12600 | 11500 | 10600 | 9900 | 9300 | 8600 | 8200 | 7700 | 7300 | — | — | — | — | — | — |
| 164 | 104 | 13200 | 13200 | 13200 | 13200 | 13200 | 12800 | 11900 | 11000 | 10100 | 6500 | 9000 | 8400 | 7900 | — | — | — | — | — | — | — |
| 156 | 106 | 13200 | 13200 | 13200 | 13200 | 13200 | 13000 | 12100 | 11200 | 10400 | 9700 | 9000 | 8600 | — | — | — | — | — | — | — | — |
| 148 | 107 | 13200 | 13200 | 13200 | 13200 | 13200 | 13200 | 12300 | 11500 | 10600 | 9900 | 9300 | — | — | — | — | — | — | — | — | — |
| 139 | 112 | 13200 | 13200 | 13200 | 13200 | 13200 | 13200 | 12800 | 11900 | 11000 | 10400 | — | — | — | — | — | — | — | — | — | — |
| 131 | 115 | 13200 | 13200 | 13200 | 13200 | 13200 | 13200 | 13200 | 12300 | 11500 | — | — | — | — | — | — | — | — | — | — | — |
| 123 | 115 | 13200 | 13200 | 13200 | 13200 | 13200 | 13200 | 13200 | 12300 | — | — | — | — | — | — | — | — | — | — | — | — |
| 115 | 115 | 13200 | 13200 | 13200 | 13200 | 13200 | 13200 | 13200 | — | — | — | — | — | — | — | — | — | — | — | — | — |
| 107 | 107 | 13200 | 13200 | 13200 | 13200 | 13200 | 13200 | — | — | — | — | — | — | — | — | — | — | — | — | — | — |
| 98 | 98 | 13200 | 13200 | 13200 | 13200 | 13200 | — | — | — | — | — | — | — | — | — | — | — | — | — | — | — |



CARGAS / LOADS

J200.12

| b ₃ d ST-SR (lb) | | Cargas máximas / Maximum loads ST-SR – 13200 lb | | | | | | | | | | | | | | | | | | | |
|-----------------------------|-------------------|----------------------------------------------------|-------|-------|-------|-------|-------|-------|-------|-------|-------|------|------|------|------|------|------|------|------|------|------|
| [ft] | 13200 lb @...(ft) | Alcance del gancho [ft] / Hook reach [ft] | | | | | | | | | | | | | | | | | | | |
| | | 33 | 49 | 66 | 82 | 98 | 107 | 115 | 123 | 131 | 139 | 148 | 156 | 164 | 172 | 180 | 189 | 197 | 205 | 213 | 221 |
| 221 | 78 | 13200 | 13200 | 13200 | 12600 | 10100 | 9300 | 8600 | 7900 | 7300 | 6800 | 6400 | 6000 | 5500 | 5300 | 4900 | 4600 | 4400 | 4200 | 4000 | 3700 |
| 213 | 85 | 13200 | 13200 | 13200 | 13200 | 11200 | 10100 | 9500 | 8600 | 8200 | 7500 | 7100 | 6600 | 6200 | 5700 | 5500 | 5100 | 4900 | 4600 | 4400 | — |
| 205 | 88 | 13200 | 13200 | 13200 | 13200 | 11700 | 10600 | 9700 | 9000 | 8400 | 7700 | 7300 | 6800 | 6400 | 6000 | 5700 | 5300 | 5100 | 4900 | — | — |
| 197 | 90 | 13200 | 13200 | 13200 | 13200 | 11900 | 11000 | 10100 | 9300 | 8600 | 7900 | 7500 | 7100 | 6600 | 6200 | 6000 | 5500 | 5300 | — | — | — |
| 189 | 92 | 13200 | 13200 | 13200 | 13200 | 12300 | 11200 | 10400 | 9500 | 8800 | 8200 | 7700 | 7300 | 6800 | 6400 | 6000 | 5700 | — | — | — | — |
| 180 | 96 | 13200 | 13200 | 13200 | 13200 | 13000 | 11900 | 10800 | 10100 | 9300 | 8600 | 8200 | 7700 | 7300 | 6800 | 6400 | — | — | — | — | — |
| 172 | 100 | 13200 | 13200 | 13200 | 13200 | 13200 | 12300 | 11200 | 10400 | 9700 | 9000 | 8400 | 7900 | 7500 | 7100 | — | — | — | — | — | — |
| 164 | 102 | 13200 | 13200 | 13200 | 13200 | 13200 | 12600 | 11700 | 10800 | 9900 | 9300 | 8600 | 8200 | 7700 | — | — | — | — | — | — | — |
| 156 | 104 | 13200 | 13200 | 13200 | 13200 | 13200 | 12800 | 11900 | 11000 | 10100 | 9500 | 8800 | 8400 | — | — | — | — | — | — | — | — |
| 148 | 105 | 13200 | 13200 | 13200 | 13200 | 13200 | 13000 | 12100 | 11000 | 10400 | 9700 | 9000 | — | — | — | — | — | — | — | — | — |
| 139 | 110 | 13200 | 13200 | 13200 | 13200 | 13200 | 13200 | 12600 | 11700 | 10800 | 10100 | — | — | — | — | — | — | — | — | — | — |
| 131 | 114 | 13200 | 13200 | 13200 | 13200 | 13200 | 13200 | 13000 | 12100 | 11200 | — | — | — | — | — | — | — | — | — | — | — |
| 123 | 114 | 13200 | 13200 | 13200 | 13200 | 13200 | 13200 | 13000 | 12100 | — | — | — | — | — | — | — | — | — | — | — | — |
| 115 | 115 | 13200 | 13200 | 13200 | 13200 | 13200 | 13200 | 13200 | — | — | — | — | — | — | — | — | — | — | — | — | — |
| 107 | 107 | 13200 | 13200 | 13200 | 13200 | 13200 | 13200 | — | — | — | — | — | — | — | — | — | — | — | — | — | — |
| 98 | 98 | 13200 | 13200 | 13200 | 13200 | 13200 | — | — | — | — | — | — | — | — | — | — | — | — | — | — | — |

CARGAS / LOADS

J200.12

| b ₃ d ST-DR (lb) | | Cargas máximas / Maximum loads ST-DR – 26400 lb | | | | | | | | | | | | | | | | | | | |
|-----------------------------|-------------------|----------------------------------------------------|-------|-------|-------|-------|-------|-------|-------|-------|------|------|------|------|------|------|------|------|------|------|------|
| [lb] | 26400 lb @...(ft) | Alcance del gancho [ft] / Hook reach [ft] | | | | | | | | | | | | | | | | | | | |
| | | 33 | 49 | 66 | 82 | 98 | 107 | 115 | 123 | 131 | 139 | 148 | 156 | 164 | 172 | 180 | 189 | 197 | 205 | 213 | 221 |
| 221 | 41 | 26400 | 21800 | 15900 | 12345 | 9900 | 9000 | 8200 | 7500 | 7100 | 6400 | 6000 | 5500 | 5100 | 4900 | 4400 | 4200 | 4000 | 3700 | 3500 | 3300 |
| 213 | 45 | 26400 | 23800 | 17400 | 13400 | 11000 | 9900 | 9000 | 8400 | 7700 | 7100 | 6600 | 6200 | 5700 | 5300 | 5100 | 4900 | 4900 | 4200 | 4000 | — |
| 205 | 46 | 26400 | 24700 | 18100 | 14100 | 11200 | 10400 | 9500 | 8600 | 7900 | 7500 | 6800 | 6400 | 6000 | 5700 | 5300 | 5100 | 4600 | 4400 | — | — |
| 197 | 47 | 26400 | 25400 | 18500 | 14300 | 11700 | 10600 | 9700 | 9000 | 8200 | 7700 | 7100 | 6600 | 6200 | 5700 | 5500 | 5100 | 4900 | — | — | — |
| 189 | 48 | 26400 | 26000 | 19000 | 14800 | 11900 | 10800 | 9900 | 9300 | 8400 | 7900 | 7300 | 6800 | 6400 | 6000 | 5700 | 5300 | — | — | — | — |
| 180 | 50 | 26400 | 26400 | 19800 | 15400 | 12600 | 11500 | 10600 | 9700 | 9000 | 8400 | 7700 | 7300 | 6600 | 6400 | 6000 | — | — | — | — | — |
| 172 | 52 | 26400 | 26400 | 20500 | 16100 | 13000 | 11900 | 11000 | 10100 | 9300 | 8600 | 7900 | 7500 | 7100 | 6600 | — | — | — | — | — | — |
| 164 | 53 | 26400 | 26400 | 21200 | 16500 | 13400 | 12300 | 11200 | 10400 | 9500 | 8800 | 8400 | 7700 | 7300 | — | — | — | — | — | — | — |
| 156 | 54 | 26400 | 26400 | 21600 | 16800 | 13700 | 12600 | 11500 | 10600 | 9700 | 9000 | 8600 | 8000 | — | — | — | — | — | — | — | — |
| 148 | 55 | 26400 | 26400 | 21800 | 17000 | 13900 | 12600 | 11700 | 10800 | 9900 | 9300 | 8600 | — | — | — | — | — | — | — | — | — |
| 139 | 57 | 26400 | 26400 | 22900 | 17900 | 14600 | 13200 | 12100 | 11200 | 10400 | 9700 | — | — | — | — | — | — | — | — | — | — |
| 131 | 59 | 26400 | 26400 | 23600 | 18500 | 15000 | 13700 | 12600 | 11700 | 10800 | — | — | — | — | — | — | — | — | — | — | — |
| 123 | 59 | 26400 | 26400 | 23600 | 18700 | 15000 | 13900 | 12600 | 11700 | — | — | — | — | — | — | — | — | — | — | — | — |
| 115 | 60 | 26400 | 26400 | 23800 | 18700 | 15200 | 13900 | 12800 | — | — | — | — | — | — | — | — | — | — | — | — | — |
| 107 | 59 | 26400 | 26400 | 23800 | 18700 | 15200 | 13900 | — | — | — | — | — | — | — | — | — | — | — | — | — | — |
| 98 | 59 | 26400 | 26400 | 23800 | 18700 | 15200 | — | — | — | — | — | — | — | — | — | — | — | — | — | — | — |



Fecha / Date: 24/08/2021



Reservado el derecho a modificaciones sin previo aviso. Declinamos toda responsabilidad derivada de la información proporcionada / Subject to modification, without prior notice. This information is supplied without liability

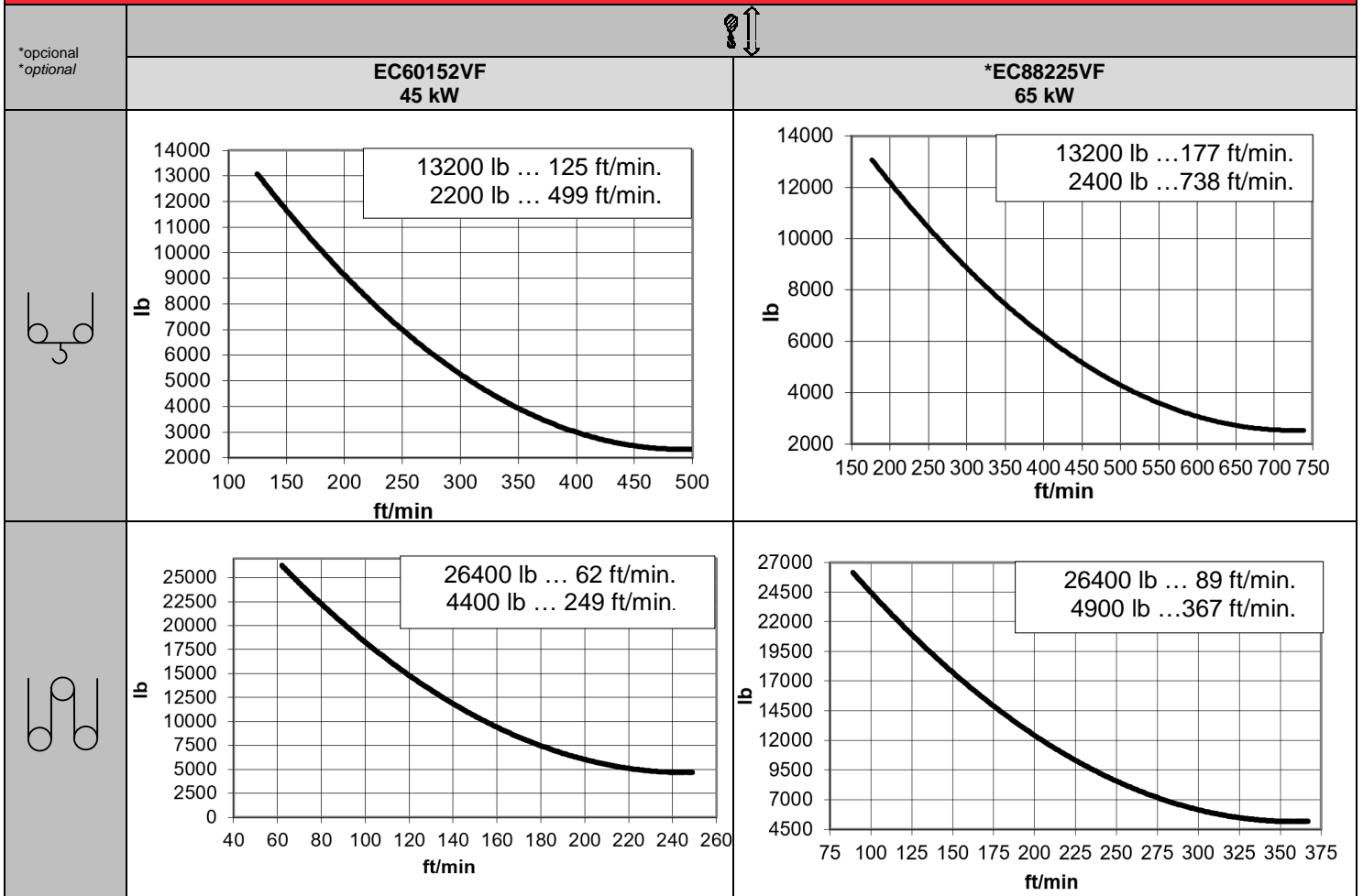

| | | | | | |
|-------------------------------|-------------------------------|--------------------------------------------------------------------|------------------------|----------------------------------------------------------------------------------------------------------------------------------------|--|
| | | | | 480V 60Hz | |
| TG2020VF 2 x 7,3 kW | OG2208VF 3 x 5,5 kW | TC770VF 5,5 kW | TH1506 11 kW | P_{TOTAL} (EC60152VF + OG2208VF + TC770VF) = 67 kW P_{TOTAL} (EC88225VF + OG2208VF + TC770VF) = 87 kW | |
| 0...66 ft/min | 0...0,8 r/min sl/min | 13200 lb 0...230 ft/min 26400 lb 0...115 ft/min | 3 ft/min | $H \leq \begin{matrix} SR & 1752 \text{ ft} \\ DR & 876 \text{ ft} \end{matrix}$ 4521 ft | |

TRANSPORTE / TRANSPORT

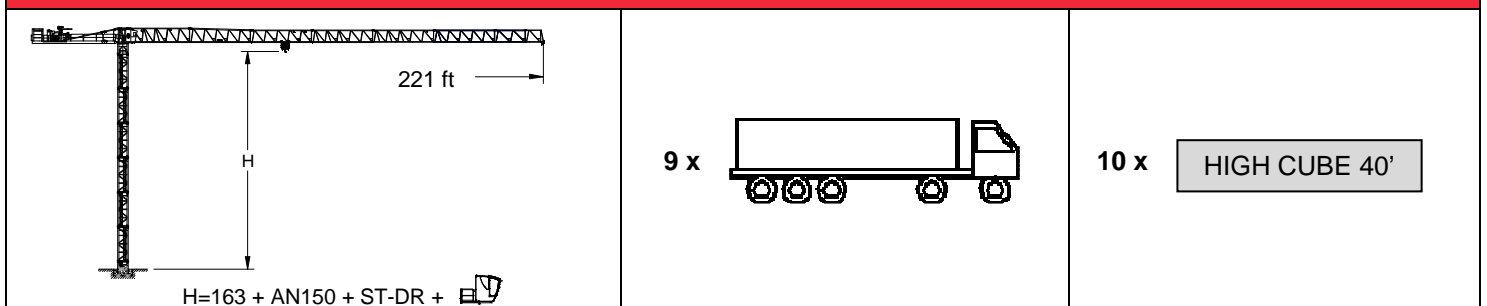





- Viento fuera de servicio / Out of service wind
- Consultar / Consult
- En servicio / In service
- Fuera de servicio / Out of service

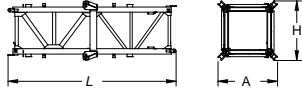
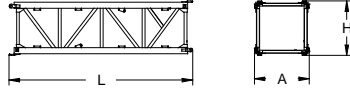
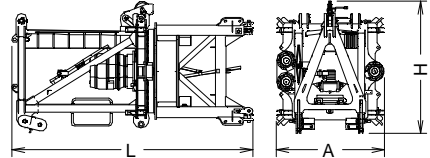
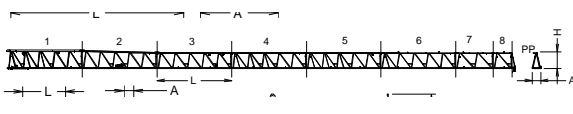
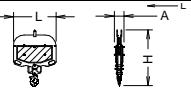
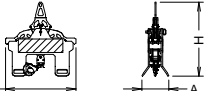
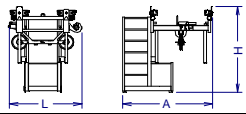

Fecha / Date: 24/08/2021

FEM 1001

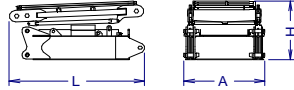
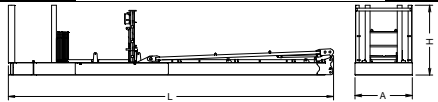
Reservado el derecho a modificaciones sin previo aviso. Declinamos toda responsabilidad derivada de la información proporcionada / Subject to modification, without prior notice. This information is supplied without liability

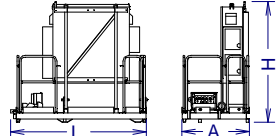
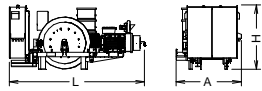
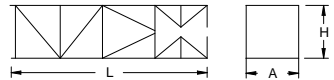
| DENOMINACIÓN / DENOMINATION | | L [ft] | A [ft] | H [ft] | P / W [lb] | |
|-------------------------------------------------------------------------------------------------------------|------------------|--------------------------------------------------------------------------------------|--------|--------|------------|-------|
| Torre inferior <i>Lower tower</i> | TI-6-150 |  | 20.3 | 7.2 | 7.2 | 7790 |
| Torre / Tower | T6-150 |  | 20.3 | 6.1 | 6.1 | 6080 |
| | TD6-150 | | 20.3 | 6.1 | 6.1 | 6460 |
| | TT6-150 | | 20.3 | 6.1 | 6.1 | 6080 |
| | T3-150 | | 10.7 | 6.1 | 6.1 | 3420 |
| | T12-150 | | 39.4 | 6.1 | 6.1 | 11420 |
| Torre asiento pista + punta de torre + orientación <i>Slewing table + tower head + slewing mechanism</i> | |  | 15.2 | 6.8 | 8.2 | 15210 |
| Tramo de pluma <i>Jib section</i> | P23-11 |  | 33.7 | 4.4 | 8.2 | 5680 |
| | P23-12+tr | | 33.7 | 3.7 | 8.1 | 5670 |
| | P20-13 | | 33.6 | 3.7 | 7.3 | 3570 |
| | P20-14 | | 33.4 | 3.7 | 7.2 | 2630 |
| | P20-15 | | 33.4 | 3.7 | 7.1 | 1800 |
| | P20-16 | | 33.4 | 3.7 | 7.3 | 1260 |
| | P20-17 | | 17.0 | 3.7 | 7.3 | 770 |
| | P20-18 | | 8.8 | 3.7 | 7.2 | 420 |
| | PP20-1 | | 2.9 | 4.2 | 8.2 | 290 |
| Polipasto <i>Hook assembly</i> | SR – 13200 lb |  | 2.8 | 0.7 | 3.7 | 490 |
| | ST-DR – 26400 lb |  | 4.6 | 1.8 | 4.9 | 1060 |
| Carro / Trolley | SR – 13200 lb |  | 5.1 | 6.3 | 6.2 | 700 |
| | ST-DR – 26400 lb |  | 5.8 | 6.4 | 6.1 | 930 |
| Contrapluma / Counterjib | C1-12 |  | 7.9 | 4.7 | 3.6 | 2380 |
| Contrapluma / Counterjib | C2-12 |  | 39.3 | 6.9 | 8.2 | 12200 |
| Plataforma y cabina / Platform and cabin | |  | 11.5 | 6.8 | 7.9 | 2470 |
| Armario eléctrico y plataforma <i>Electrical cabinet and platform</i> | |  | 8.7 | 4.3 | 7.7 | 1800 |
| Soporte y elevación (sin cable) <i>Support and hoisting (without rope)</i> | |  | 12.5 | 6.0 | 6.0 | 8180 |
| Estructura torre de montaje <i>Jacking cage structure</i> | TM6-150 |  | 33.9 | 8.0 | 7.6 | 7720 |

SR

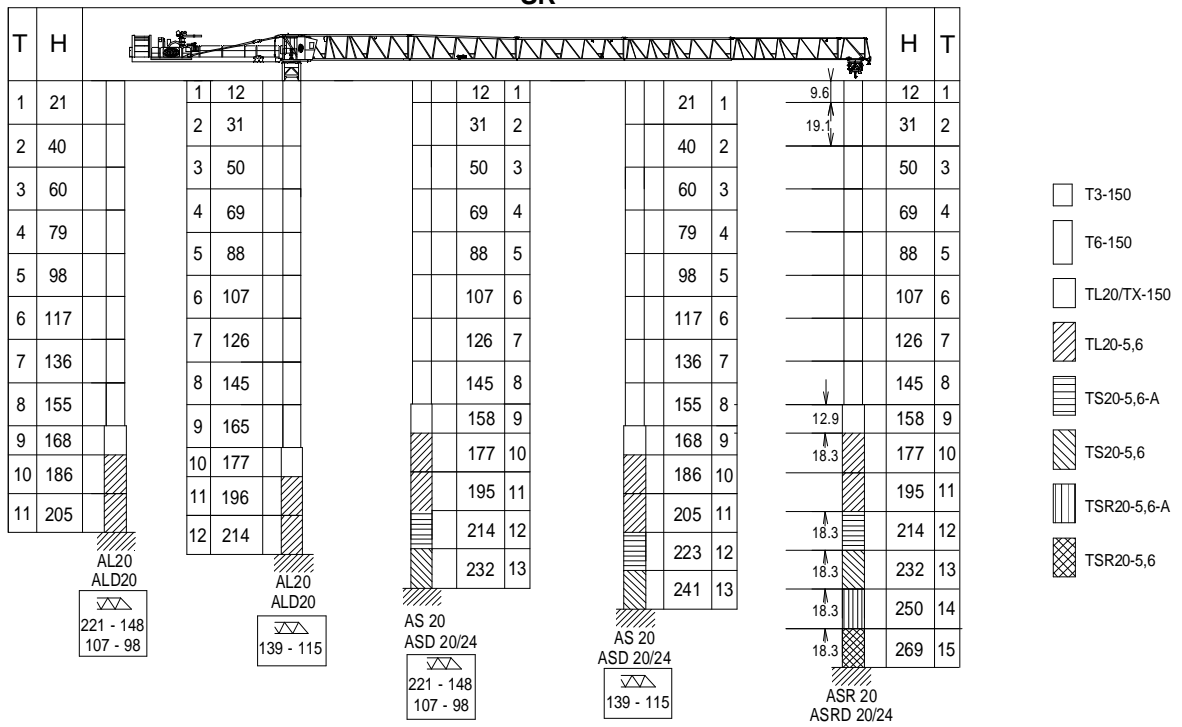

ST - DR

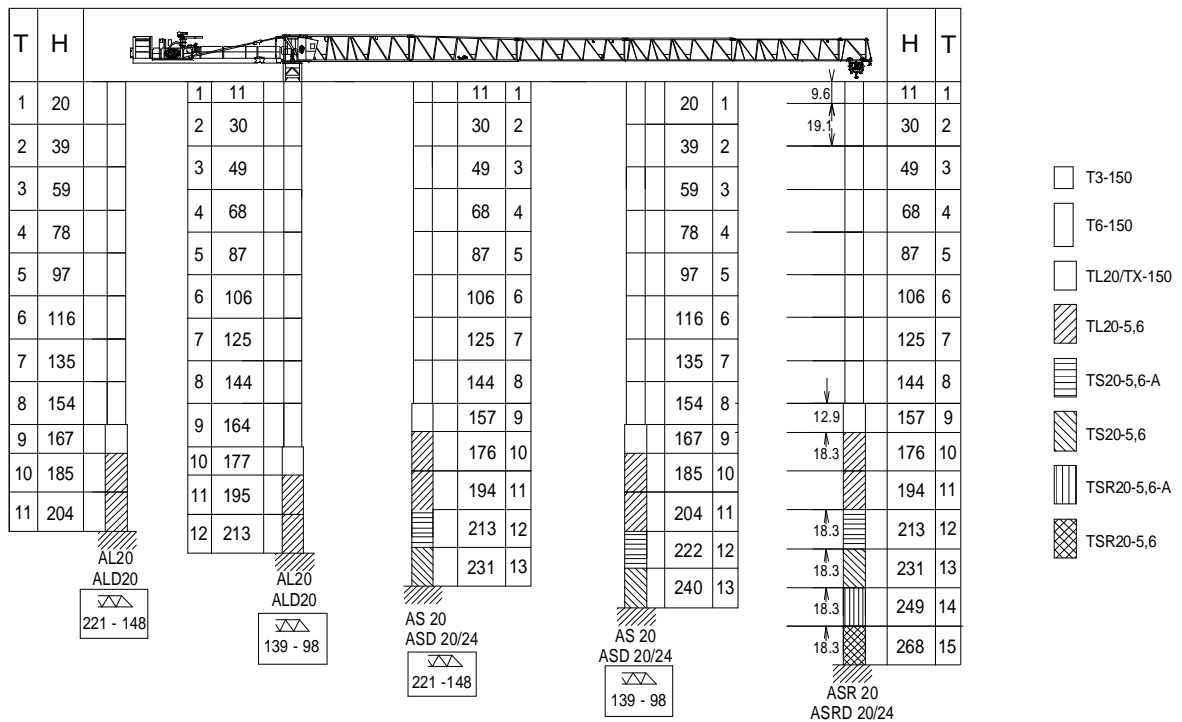

T: Torre / Tower
H: Altura / Height

$H_{ST-SR} = H_{ST-DR}$

| | |
|-------------|------------|
| TL20/TX-150 | 161.36.000 |
| TL20-5,6 | 204.31.400 |
| TS20-5,6A | 204.31.500 |
| TS20-5,6 | 204.31.200 |
| TSR20-5,6A | 204.31.300 |
| TSR20-5,6 | 204.31.000 |

| | |
|------------|------------|
| AL 20 | 153.21.800 |
| ALD 20 | 160.21.250 |
| AS 20 | 160.21.010 |
| ASD 20/24 | 160.21.080 |
| ASR 20 | 160.21.200 |
| ASRD 20/24 | 156.21.000 |



Otras configuraciones de torre / Other tower configuration



Ctra./Rd. Madrid - Irún Km. 415 - 20.213 IDIAZABAL [Gipuzkoa] ESPAÑA / SPAIN
P.O. Box, 23 - 20.200 BEASAIN - E-mail: jaso@jaso.com
Tel. +34 943 - 18 70 00 • Fax. +34 943 - 18 70 20
www.jaso.com

Fecha / Date: 24/08/2021

FEM 1001

DELEGACION / DEALER