

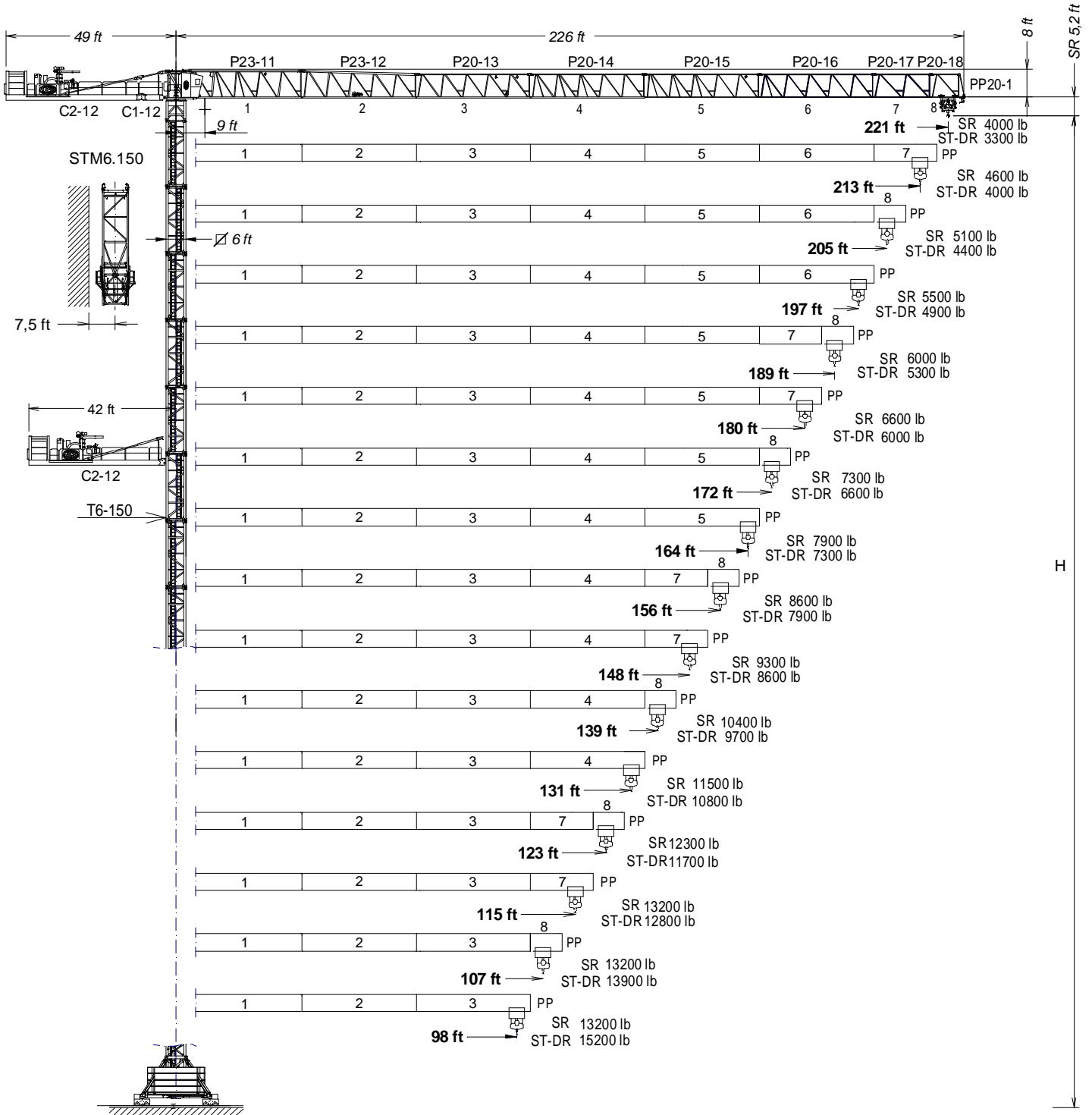

EN 14439  
C25

UNE-EN-ISO 9001



C2-12	171.50.200	P20-14	171.43.000	PP20-1	171.47.000	AN 150	161.21.000
C1-12	171.50.050	P20-15	171.44.000	T3-150	161.32.000	BNI 45-150	161.20.500
P23-11	171.40.000	P20-16	171.45.000	T6-150	161.31.000	BNI 6-150	161.20.000
P23-12	171.41.000	P20-17	171.46.000	TD6-150	161.31.700	ABH 100	201.23.000
P20-13	171.42.000	P20-18	171.46.500	T12-150	161.31.500		





Fecha / Date: 24/08/2021







FEM 1005 - C25

Reservado el derecho a modificaciones sin previo aviso. Declinamos toda responsabilidad derivada de la información proporcionada / Subject to modification, without prior notice. This information is supplied without liability /

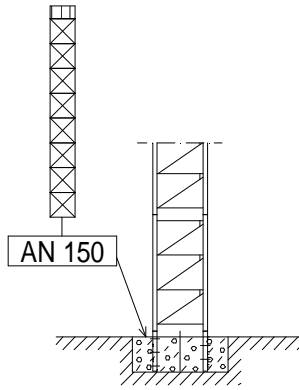

(H<sub>SR</sub>) ESTACIONARIA 1 / STATIONARY 1

	H(m)		
221 - 98	164	8	1







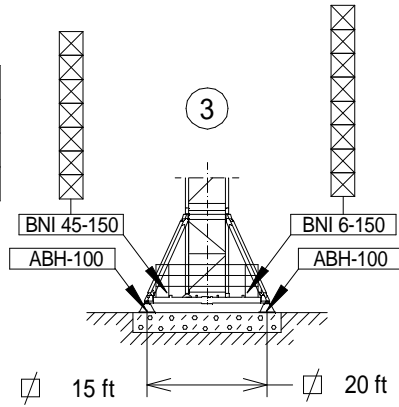

-  T3-150
-  T6-150
-  TD6-150
-  T12-150

(H<sub>SR</sub>) ESTACIONARIA 3 / STATIONARY 3



	H(ft)		
221 - 213	158	7	-
205 - 164	148	6	1
156 - 98	139	6	-







	H(ft)		
221 - 189	167	7	1
180 - 98	177	8	-



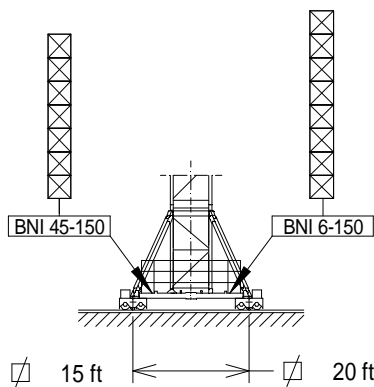

-  T3-150
-  T6-150
-  TD6-150
-  T12-150

(H<sub>SR</sub>) TRASLACIÓN / TRAVELLING

	H(ft)		
221 - 213	158	7	-
205 - 164	149	6	1
156 - 98	139	6	-



	H(ft)		
221 - 189	168	7	1
180 - 98	178	8	-

-  T3-150
-  T6-150
-  TD6-150
-  T12-150

H =

Altura máxima bajo gancho sin arristrar (m).  
Maximum height under hook without fastening (m).

$$H_{ST-DR} = H_{SR} - 1 \text{ ft}$$

$$H_{ST-SR} = H_{ST-DR}$$

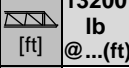
 SR (lb)		Cargas máximas / Maximum loads																			
		SR – 13200 lb																			
 [ft] @...(ft)		Alcance del gancho [ft] / Hook reach [ft]																			
		33	49	66	82	98	107	115	123	131	139	148	156	164	172	180	189	197	205	213	221
<b>221</b>	79	13200	13200	13200	12800	10400	9500	8800	8200	7500	7100	6600	6200	5700	5511	5100	4900	4600	4400	5100	4000
<b>213</b>	86	13200	13200	13200	13200	11500	10600	9700	8800	8400	7700	7300	6800	6400	6000	5700	5300	5100	4900	4600	—
<b>205</b>	89	13200	13200	13200	13200	11900	10800	9900	9300	8600	7900	7500	7000	6600	6200	6000	5500	5300	5100	—	—
<b>197</b>	92	13200	13200	13200	13200	12300	11200	10400	9500	8800	8400	7700	7300	6800	6400	6200	5700	5500	—	—	—
<b>189</b>	94	13200	13200	13200	13200	12600	11500	10600	9700	9000	8400	7900	7500	7100	6600	6200	6000	—	—	—	—
<b>180</b>	98	13200	13200	13200	13200	13200	12100	11000	10400	9500	8800	8400	7900	7500	7100	6600	—	—	—	—	—
<b>172</b>	101	13200	13200	13200	13200	13200	12600	11500	10600	9900	9300	8600	8200	7700	7300	—	—	—	—	—	—
<b>164</b>	104	13200	13200	13200	13200	13200	12800	11900	11000	10100	6500	9000	8400	7900	—	—	—	—	—	—	—
<b>156</b>	106	13200	13200	13200	13200	13200	13000	12100	11200	10400	9700	9000	8600	—	—	—	—	—	—	—	—
<b>148</b>	107	13200	13200	13200	13200	13200	13200	12300	11500	10600	9900	9300	—	—	—	—	—	—	—	—	—
<b>139</b>	112	13200	13200	13200	13200	13200	13200	12800	11900	11000	10400	—	—	—	—	—	—	—	—	—	—
<b>131</b>	115	13200	13200	13200	13200	13200	13200	13200	12300	11500	—	—	—	—	—	—	—	—	—	—	—
<b>123</b>	115	13200	13200	13200	13200	13200	13200	13200	12300	—	—	—	—	—	—	—	—	—	—	—	—
<b>115</b>	115	13200	13200	13200	13200	13200	13200	13200	—	—	—	—	—	—	—	—	—	—	—	—	—
<b>107</b>	107	13200	13200	13200	13200	13200	13200	—	—	—	—	—	—	—	—	—	—	—	—	—	—
<b>98</b>	98	13200	13200	13200	13200	13200	—	—	—	—	—	—	—	—	—	—	—	—	—	—	—







Fecha / Date: 24/08/2021



**FEM 1005 - C25**

Reservado el derecho a modificaciones sin previo aviso. Declinamos toda responsabilidad derivada de la información proporcionada / Subject to modification, without prior notice. This information is supplied without liability /

<b>CARGAS / LOADS</b>																					<b>J200.12</b>	
 ST-SR (lb)		Cargas máximas / Maximum loads ST-SR – 13200 lb																				
 [ft]	13200 lb @...(ft)	Alcance del gancho [ft] / Hook reach [ft]																				
		33	49	66	82	98	107	115	123	131	139	148	156	164	172	180	189	197	205	213	221	
221	78	13200	13200	13200	12600	10100	9300	8600	7900	7300	6800	6400	6000	5500	5300	4900	4600	4400	4200	4000	3700	
213	85	13200	13200	13200	13200	11200	10100	9500	8600	8200	7500	7100	6600	6200	5700	5500	5100	4900	4600	4400	—	
205	88	13200	13200	13200	13200	11700	10600	9700	9000	8400	7700	7300	6800	6400	6000	5700	5300	5100	4900	—	—	
197	90	13200	13200	13200	13200	11900	11000	10100	9300	8600	7900	7500	7100	6600	6200	6000	5500	5300	—	—	—	
189	92	13200	13200	13200	13200	12300	11200	10400	9500	8800	8200	7700	7300	6800	6400	6000	5700	—	—	—	—	
180	96	13200	13200	13200	13200	13000	11900	10800	10100	9300	8600	8200	7700	7300	6800	6400	—	—	—	—	—	
172	100	13200	13200	13200	13200	13200	12300	11200	10400	9700	9000	8400	7900	7500	7100	—	—	—	—	—	—	
164	102	13200	13200	13200	13200	13200	12600	11700	10800	9900	9300	8600	8200	7700	—	—	—	—	—	—	—	
156	104	13200	13200	13200	13200	13200	12800	11900	11000	10100	9500	8800	8400	—	—	—	—	—	—	—	—	
148	105	13200	13200	13200	13200	13200	13000	12100	11000	10400	9700	9000	—	—	—	—	—	—	—	—	—	
139	110	13200	13200	13200	13200	13200	13200	12600	11700	10800	10100	—	—	—	—	—	—	—	—	—	—	
131	114	13200	13200	13200	13200	13200	13200	13000	12100	11200	—	—	—	—	—	—	—	—	—	—	—	
123	114	13200	13200	13200	13200	13200	13200	13000	12100	—	—	—	—	—	—	—	—	—	—	—	—	
115	115	13200	13200	13200	13200	13200	13200	13200	—	—	—	—	—	—	—	—	—	—	—	—	—	
107	107	13200	13200	13200	13200	13200	13200	—	—	—	—	—	—	—	—	—	—	—	—	—	—	
98	98	13200	13200	13200	13200	13200	—	—	—	—	—	—	—	—	—	—	—	—	—	—	—	

<b>CARGAS / LOADS</b>																					<b>J200.12</b>	
 ST-DR (lb)		Cargas máximas / Maximum loads ST-DR – 26400 lb																				
 [lb]	26400 lb @...(ft)	Alcance del gancho [ft] / Hook reach [ft]																				
		33	49	66	82	98	107	115	123	131	139	148	156	164	172	180	189	197	205	213	221	
221	41	26400	21800	15900	12345	9900	9000	8200	7500	7100	6400	6000	5500	5100	4900	4400	4200	4000	3700	3500	3300	
213	45	26400	23800	17400	13400	11000	9900	9000	8400	7700	7100	6600	6200	5700	5300	5100	4900	4900	4200	4000	—	
205	46	26400	24700	18100	14100	11200	10400	9500	8600	7900	7500	6800	6400	6000	5700	5300	5100	4600	4400	—	—	
197	47	26400	25400	18500	14300	11700	10600	9700	9000	8200	7700	7100	6600	6200	5700	5500	5100	4900	—	—	—	
189	48	26400	26000	19000	14800	11900	10800	9900	9300	8400	7900	7300	6800	6400	6000	5700	5300	—	—	—	—	
180	50	26400	26400	19800	15400	12600	11500	10600	9700	9000	8400	7700	7300	6600	6400	6000	—	—	—	—	—	
172	52	26400	26400	20500	16100	13000	11900	11000	10100	9300	8600	7900	7500	7100	6600	—	—	—	—	—	—	
164	53	26400	26400	21200	16500	13400	12300	11200	10400	9500	8800	8400	7700	7300	—	—	—	—	—	—	—	
156	54	26400	26400	21600	16800	13700	12600	11500	10600	9700	9000	8600	8000	—	—	—	—	—	—	—	—	
148	55	26400	26400	21800	17000	13900	12600	11700	10800	9900	9300	8600	—	—	—	—	—	—	—	—	—	
139	57	26400	26400	22900	17900	14600	13200	12100	11200	10400	9700	—	—	—	—	—	—	—	—	—	—	
131	59	26400	26400	23600	18500	15000	13700	12600	11700	10800	—	—	—	—	—	—	—	—	—	—	—	
123	59	26400	26400	23600	18700	15000	13900	12600	11700	—	—	—	—	—	—	—	—	—	—	—	—	
115	60	26400	26400	23800	18700	15200	13900	12800	—	—	—	—	—	—	—	—	—	—	—	—	—	
107	59	26400	26400	23800	18700	15200	13900	—	—	—	—	—	—	—	—	—	—	—	—	—	—	
98	59	26400	26400	23800	18700	15200	—	—	—	—	—	—	—	—	—	—	—	—	—	—	—	









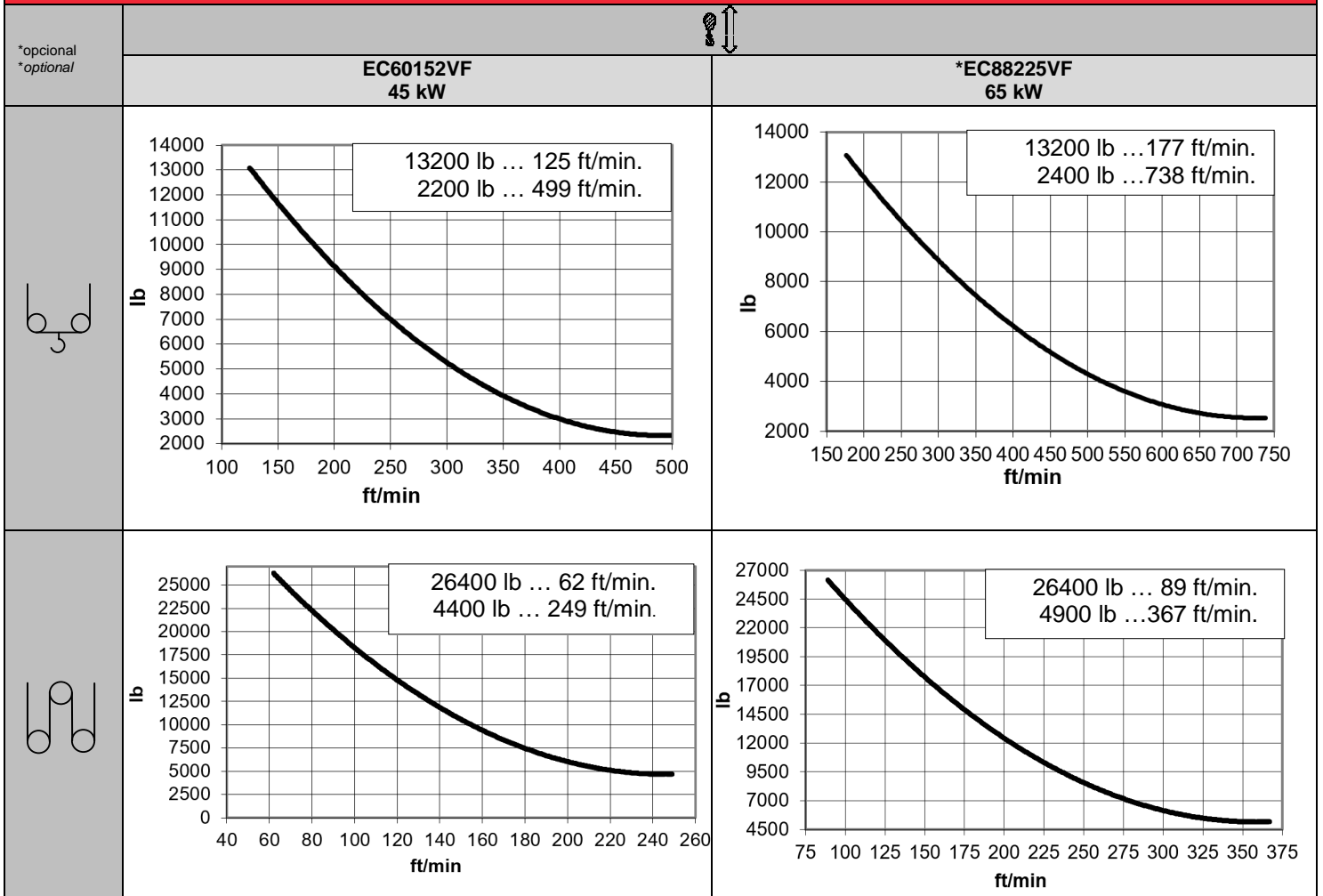



Fecha / Date: 24/08/2021

 FEM 1005 - C25

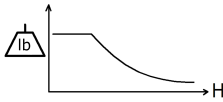
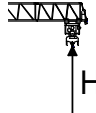
Reservado el derecho a modificaciones sin previo aviso. Declinamos toda responsabilidad derivada de la información proporcionada / Subject to modification, without prior notice. This information is supplied without liability /

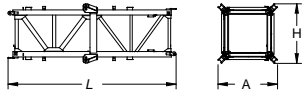
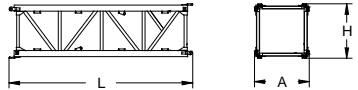
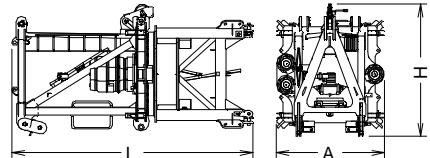
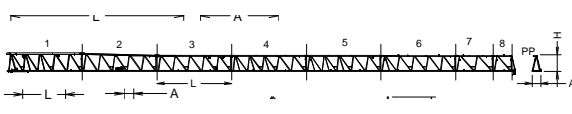
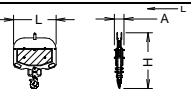

				 480V 60Hz	 
<b>TG2020VF</b> 2x7,3 kW	<b>OG2208VF</b> 3 x 5,5 kW	<b>TC770VF</b> 5,5 kW	<b>TH1506</b> 11 kW	<b>P<sub>TOTAL</sub> (EC60152VF + OG2208VF + TC770VF) = 67 kW</b> <b>P<sub>TOTAL</sub> (EC88225VF + OG2208VF + TC770VF) = 87 kW</b>	
0...66 ft/min	0...0,8 r/min sl/min	13200 lb 0...230 ft/min  26400 lb 0...115 ft/min	3 ft/min	 $H \leq \begin{matrix} SR \\ DR \end{matrix} \begin{matrix} 1752 \text{ ft} \\ 876 \text{ ft} \end{matrix}$   4521 ft	

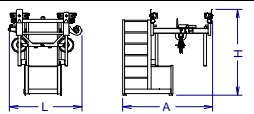
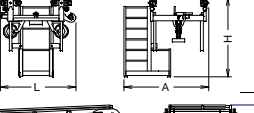
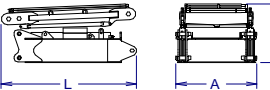
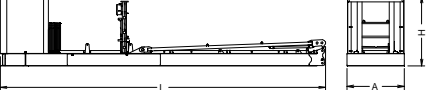
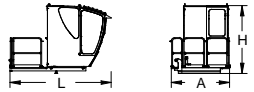
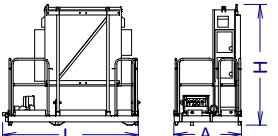
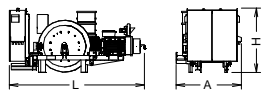
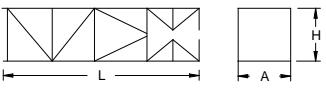
DENOMINACIÓN / DENOMINATION		L [ft]	A [ft]	H [ft]	P / W [lb]	
Torre inferior <i>Lower tower</i>	TI-6-150		20.3	7.2	7.2	7790
Torre / Tower	T6-150		20.3	6.1	6.1	6080
	TD6-150		20.3	6.1	6.1	6460
	TT6-150		20.3	6.1	6.1	6080
	T3-150		10.7	6.1	6.1	3420
	T12-150		39.4	6.1	6.1	11420
Torre asiento pista + punta de torre + orientación <i>Slewing table + tower head + slewing mechanism</i>			15.2	6.8	8.2	15210
Tramo de pluma <i>Jib section</i>	P23-11		33.7	4.4	8.2	5680
	P23-12+tr		33.7	3.7	8.1	5670
	P20-13		33.6	3.7	7.3	3570
	P20-14		33.4	3.7	7.2	2630
	P20-15		33.4	3.7	7.1	1800
	P20-16		33.4	3.7	7.3	1260
	P20-17		17.0	3.7	7.3	770
	P20-18		8.8	3.7	7.2	420
	PP20-1		2.9	4.2	8.2	290
Polipasto <i>Hook assembly</i>	SR – 13200 lb		2.8	0.7	3.7	490
	ST-DR – 26400 lb		4.6	1.8	4.9	1060
Carro / Trolley	SR – 13200 lb		5.1	6.3	6.2	700
	ST-DR – 26400 lb		5.8	6.4	6.1	930
Contrapluma / Counterjib	C1-12		7.9	4.7	3.6	2380
Contrapluma / Counterjib	C2-12		39.3	6.9	8.2	12200
Plataforma y cabina / Platform and cabin			11.5	6.8	7.9	2470
Armario eléctrico y plataforma <i>Electrical cabinet and platform</i>			8.7	4.3	7.7	1800
Soporte y elevación (sin cable) <i>Support and hoisting (without rope)</i>			12.5	6.0	6.0	8180
Estructura torre de montaje <i>Jacking cage structure</i>		TM6-150 	33.9	8.0	7.6	7720

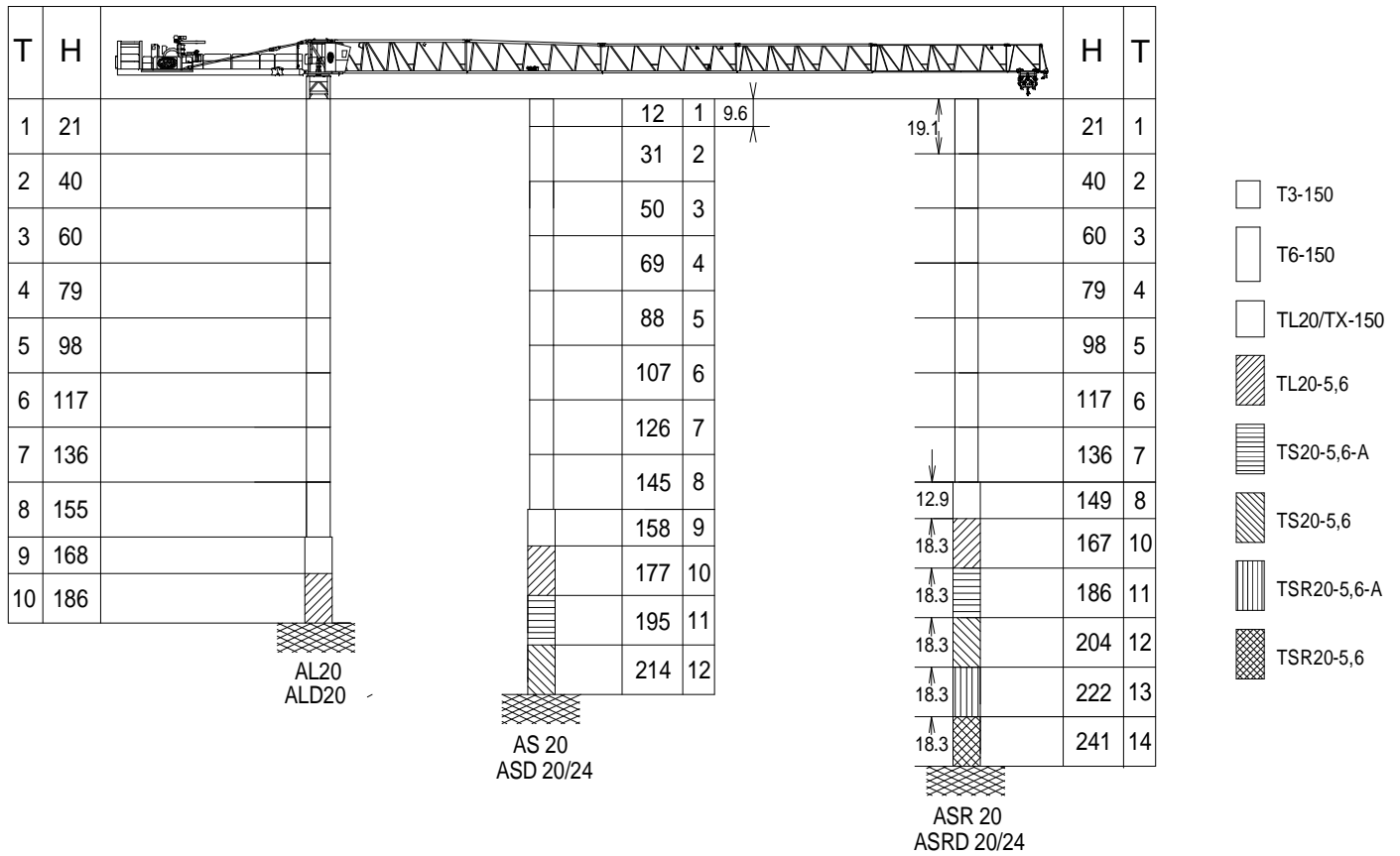

<p>T: Torre / Tower H: Altura / Height</p>	<p><math>H_{ST-DR} = H_{SR} - 1 \text{ ft}</math> <math>H_{ST-SR} = H_{ST-DR}</math></p>	<p>TL20/TX-150----- 161.36.000                  TL20-5,6 ----- 204.31.400                  TS20-5,6A ----- 204.31.500                  TS20-5,6 ----- 204.31.200                  TSR20-5,6A ----- 204.31.300                  TSR20-5,6 ----- 204.31.000</p>	<p>AL 20----- 153.21.800                  ALD 20 ----- 160.21.250                  AS 20 ----- 160.21.010                  ASD 20/24 ----- 160.21.080                  ASR 20 ----- 160.21.200                  ASRD 20/24 ----- 156.21.000</p>
--	--	---	---

Otras configuraciones de torre / Other tower configuration

**TRANSPORTE / TRANSPORT**

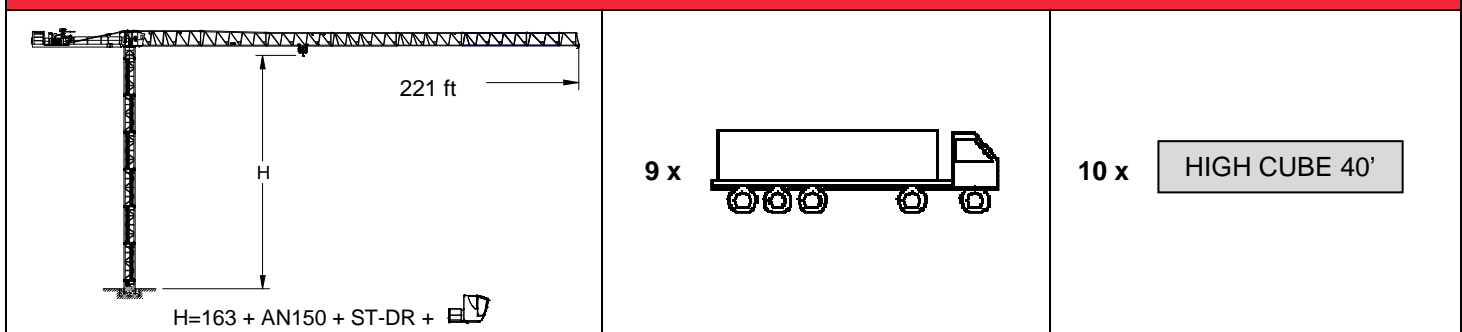

- Viento fuera de servicio / Out of service wind
- Consultar / Consult
- En servicio / In service
- Fuera de servicio / Out of service



Ctra./Rd. Madrid - Irún Km. 415 - 20.213 IDIAZABAL [Gipuzkoa] ESPAÑA / SPAIN  
 P.O. Box, 23 - 20.200 BEASAIN - E-mail: jaso@jaso.com  
 Tel. +34 943 - 18 70 00 • Fax. +34 943 - 18 70 20  
**www.jaso.com**

Fecha / Date: 24/08/2021

**FEM 1005 - C25**

DELEGACION / DEALER