

GRUA TORRE / TOWER CRANE

GRUE A TOUR / БАШЕННЫЙ КРАН /

رافعة برجية / KULE VINÇ

J5010



EN 14439
C25

UNE-EN-ISO 9001

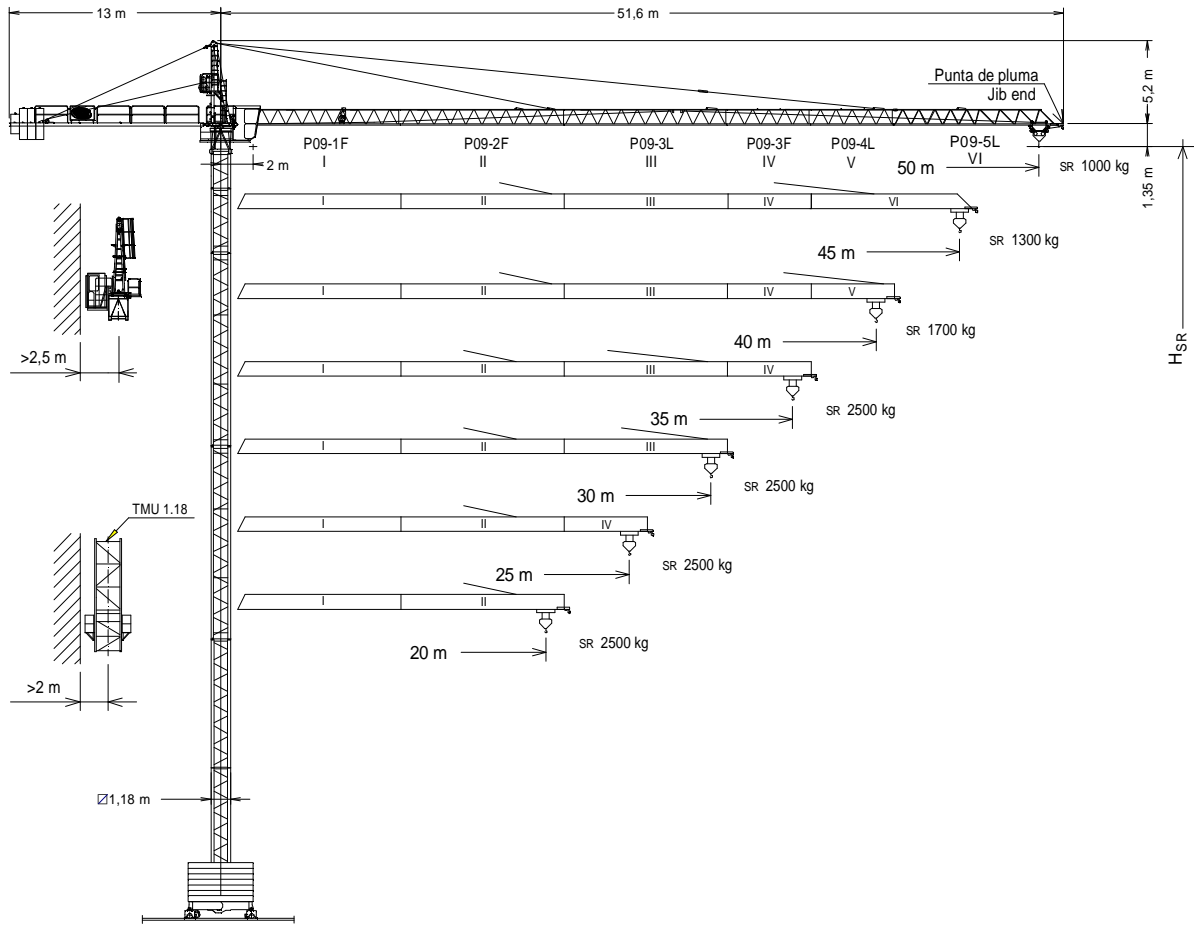

Altura máxima bajo gancho sin arriostrar (m). Maximum height under hook without fastening (m). Hauteur maximale sous crochet sans ancrage (m). Максимальная высота под крюком без крепления (m). Bağlantısız maksimum kanca altı yüksekliği (m). أقصى ارتفاع تحت الخطاف بدون ربط (m)	TMU 1.18 ----- 202.35.500	TN 4 ----- 146.32.000
H _{SR} =	P09-1F ----- 157.40.000	TN2 ----- 146.32.500
(m)	P09-2F ----- 157.41.000	BTX 45/BEX 45 ----- 137.20.500
	P09-3L ----- 155.42.000	BTX 38R/BEX 38R ----- 137.20.000
	P09-3F ----- 157.43.000	BTX 38/BEX 38 ----- 149.20.000
	P09-4L ----- 155.43.000	BEX 45L ----- 155.23.500
	P09-5L ----- 155.44.500	BEX 38RL ----- 155.23.800
	Punta de pluma / Jib end* ----- 155.45.000	BEX 38L ----- 155.23.000
	TR 12 ----- 146.30.000	ABH 75 ----- 152.23.000
	TN 12 ----- 146.31.000	ABH 90 ----- 146.23.000
	TR 8RM ----- 202.30.000	AR 12 ----- 137.21.000
	TR 8M ----- 146.30.800	AN 12 ----- 146.21.000
	TR 4 ----- 800.32.300	BE 442 ----- 146.24.850



* Punta de pluma / Jib end / Pointe de flèche / Конец стрелы / Вот усу / مقدمة الذراع

(H) TRASLACIÓN / TRAVELLING /

TRASLATION / ПЕРЕМЕЩЕНИЕ / RAY YÜRÜYÜŞLÜ / متحركة

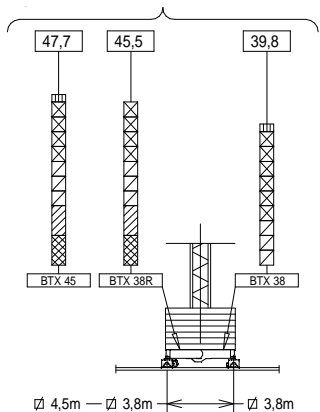

(H) ESTACIONARIA / STATIONARY /

STATIONAIRE / СТАЦИОНАРНОЕ СОСТОЯНИЕ / SABIT / ثابتة

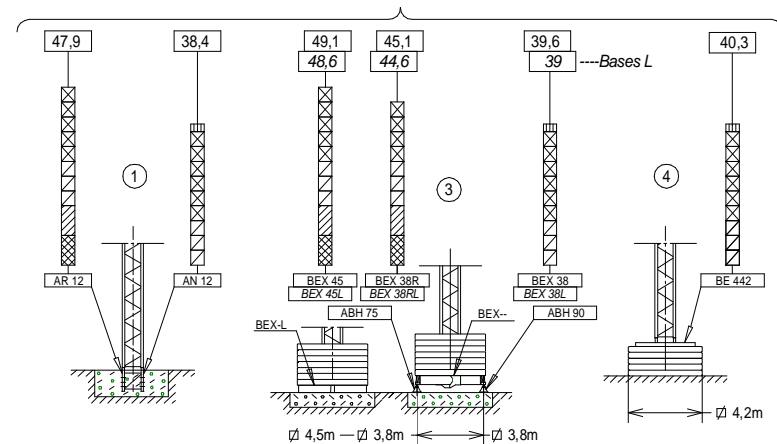

Fecha / Date: 20/01/2016

FEM 1005 - C25



Reservado el derecho a modificaciones sin previo aviso. Declinamos toda responsabilidad derivada de la información proporcionada / Subject to modification, without previous warning. This information is supplied without liability / L'entreprise se réserve le droit de procéder à des modifications sans préavis. Nous déclinons toute responsabilité quant aux informations fournies / Мы оставляем за собой право на внесение изменений без предварительного уведомления. Мы снимаем с себя любую ответственность в отношении предоставленной информации / Önceden bildirilmeksizin değiştirilme hakkı saklıdır. Verilen bilgiler için hiçbir sorumluluk kabul etmemekteyiz











CARGAS / LOADS / CHARGES / НАГРУЗКИ / YÜKLER / الأحمال **J5010**

SR1 (kg)		Cargas máximas / Maximum loads / Charges maximales / Максимальные нагрузки / Maksimum yük / أقصى حمولة						
		SR1-2000 kg						
	2000 kg @...[m]	Alcance del gancho [m] / Hook reach [m] / Portée du crochet (m) / Радиус действия крюка (m) / Kancanın yüksekliği (m) / مدى الخطاف						
		20	25	30	35	40	45	50
50 m	27,3	2000	2000	1800	1515	1300	1135	1000
45 m	30,9	2000	2000	2000	1730	1490	1300	—
40 m	34,5	2000	2000	2000	1970	1700	—	—
35 m	35,0	2000	2000	2000	2000	—	—	—
30 m	30,0	2000	2000	2000	—	—	—	—
25 m	25,0	2000	2000	—	—	—	—	—
20 m	20,0	2000	—	—	—	—	—	—

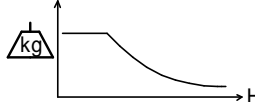

CARGAS / LOADS / CHARGES / НАГРУЗКИ / YÜKLER / الأحمال **J5010**

SR2 (kg)		Cargas máximas / Maximum loads / Charges maximales / Максимальные нагрузки / Maksimum yük / أقصى حمولة						
		SR2-2500 kg						
	2500 kg @...[m]	Alcance del gancho [m] / Hook reach [m] / Portée du crochet (m) / Радиус действия крюка (m) / Kancanın yüksekliği (m) / مدى الخطاف						
		20	25	30	35	40	45	50
50 m	22,2	2500	2200	1800	1515	1300	1135	1000
45 m	25,0	2500	2500	2050	1730	1490	1300	—
40 m	28,1	2500	2500	2335	1970	1700	—	—
35 m	35,0	2500	2500	2500	2500	—	—	—
30 m	30,0	2500	2500	2500	—	—	—	—
25 m	25,0	2500	2500	—	—	—	—	—
20 m	20,0	2500	—	—	—	—	—	—

CARACTERISTICAS DE MECANISMOS / MECHANISMS FEATURES **J5010**

CARACTÉRISTIQUES DES MÉCANISMES / ХАРАКТЕРИСТИКИ МЕХАНИЗМОВ / MEKANİZMALARIN ÖZELLİKLERİ / الخصائص الآلية								
*opcional *optional *en option *опция *opsiyonel *اختياري								
	EC1846 SR2 13,2 kW	EC1856 SR1 13,2 kW	*EC2566VF SR2 18,4 kW	*EC2580VF SR1 18,4 kW	☑ 2,8/3,8 / 4,5m TG825VF 2x3 kW	OG708VF 5,5 kW	TC360 / *TC360VF 1,9 / *1,8 kW	TH1010 9,2 kW
$\frac{b_d}{m/min}$	1,3 2,5 2,5 46 23 5	1,1 2 2 56 28 6	1,3 2,5 0..64 0..32	1,1 2 0..82 0..41	0...25 m/min	0...0,8 r/min sl/min	30/60 m/min *0...30 *30...60 m/min	1 m/min
	H ≤ SR 193 m		SR 189 m		 P_{TOTAL} (EC1846/EC1856 + OG708VF + TC360) = 20,6 Kw P_{TOTAL} (*EC2566VF/*EC2580VF + OG708VF + *TC360VF) = *25,7 kW 400V 50Hz			
					 EC1846 EC1856 TC360 TH1010 kW +20% m/min +20%			

LASTRES INFERIORES / LOWER BALLASTS / LESTS INFÉRIEURS / НИЖНИЙ БАЛЛАСТ / ALT AĞIRLIK TAŞLARI / ثقُل **J5010**

		H (m)		18	22	30	40	47,7	49,1
BEX 45 / BTX 45				6		8	10	14	16
BEX45L				8			10	14	16
BEX 38R / BTX 38R				6	8	10	12	16	6
BEX 38 / BTX 38		4100 kg		6	8	10	12	----	----
BEX 38RL				8		10	12	16	----
BEX 38L				8		10	12	----	----
		H (m)		31,9			40,3		
BE 442				16		20			

H: Altura bajo gancho / Height under hook / Hauteur maximale sous crochet / Высота под крюком / Kanca altı yüksekliği / الارتفاع أسفل الخطاف
 Para alturas intermedias tomar el lastre correspondiente a la altura superior / For intermediate heights take the ballast corresponding to the higher height / Pour les hauteurs intermédiaires, opter pour le lest correspondant à la hauteur immédiatement supérieure / Для промежуточных высот возьмите балласт, соответствующий большей высоте / Orta yükseklikler için daha üst bir yüksekliğe karşılık gelen ağırlığı alınız. / لارتفاعات البينية يرجى استخدام الثقل العائد للارتفاع الأعلى /

Fecha / Date: 20/01/2016

 **FEM 1005 - C25**



Reservado el derecho a modificaciones sin previo aviso. Declinamos toda responsabilidad derivada de la información proporcionada / Subject to modification, without previous warning. This information is supplied without liability / L'entreprise se réserve le droit de procéder à des modifications sans préavis. Nous déclinons toute responsabilité quant aux informations fournies / Мы оставляем за собой право на внесение изменений без предварительного уведомления. Мы снимаем с себя любую ответственность в отношении предоставленной информации / Önceden bildirilmeksizin değiştirilme hakkı saklıdır. Verilen bilgiler için hiçbir sorumluluk kabul etmemekteyiz / حقوق التغيير محفوظة دون إشعار مسبق. دون أدنى مسؤولية عن المعلومات المقدمة

DENOMINACIÓN / DENOMINATION / DÉSIGNATION / НАЗВАНИЕ / AÇIKLAMA / اسم		L [m]	A [m]	H [m]	P / W [kg]		
Torre Tower Tour Башня Kule برج	TR 8RM – TR 8M TR 12 – TN 12 TR 4 TN 4 TN 2			8,07 12,01 3,96 4,09 2,29	1,19 1,19 1,18 1,19 1,19	1,19 1,19 1,18 1,19 1,19	2575-2515 2840-2780 1070 1055 785
Conjunto asiento pista, punta de torre, orientación y elevación Slewing table assembly, tower head, slewing and hoisting mechanism Groupe pivot + porte-flèche + mécanisme d'orientation + de levage Сиденье площадки + верхняя секция башни + поворотный механизм + подъемный механизм Göbek +kulelin kafa bölümü+mekanizma+vinç kulesi مجموعة وحدة الدوارن + رأس البرج + آلية الدوران + آلية الرفع				6,97	1,65	2,42	4090
Tramo de pluma Jib section Tronçon de flèche Секция стрелы Vom bölümü أجزاء الذراع	P09 1F (I) P09 2F (II) P09 3L (III) P09 3F (IV) P09 4L (V) P09 5L (VI)			10,15 10,15 10,15 5,26 5,26 10,12	1 0,86 0,86 0,86 0,86 0,86	1,16 1,09 1,09 1,03 1,09 1,09	705 560 565 235 250 407
Polipasto / Hook assembly / Palan / Полупаст / Kanca takımı / بكرة	SR			0,76	0,16	0,96	135
Carro / Trolley / Chariot / Грузовая тележка / عرببة / Şaryo	SR			1	1,33	0,73	110
Contrapluma con plataformas / Counterjib with platforms Contre-flèche avec plateformes / Противовесная консоль с платформами / Platformlu kuyruk / الذراع المقابل مع المنصة				11,95	1,35	0,4	942
Plataforma y cabina / Platform and cabin / Plateforme et cabine Платформа и кабина / Platform ve kabin / منصة وكابينة				3,69	1,63	2,25	820
Contrapeso / Counterweight / Contrepoids / Grande / Big / Grand / Большой / Büyük / كبير Противовес / Denge ağırlığı / اوزان معاكسة / Pequeño / Small / Petit / Малый / Küçük / صغير				1,08 1,08	0,50 0,50	2,02 1,30	2360 1500
Base grúa Testero largo Crane base Long carriage Base de la grue. Palonnier long Основание крана. Длинная передняя часть Vinç tabanı. Uzun vinç arabası قاعدة الرافعة مقدّمة طويلة (للكابينة)	BTX 38 BTX 38R BTX 45			6,11 6,11 7,01	0,64 0,64 0,64	1,53 1,57 1,57	1576 1792 2065
	BTX 38L BTX 38RL BTX 45L			5,46 5,46 4,01	0,55 0,55 0,55	0,97 0,88 0,88	1160 850 660
	BEX 38 BEX 38R BEX 45			5,56 5,56 6,55	0,3 0,3 0,3	1,27 1,40 1,41	1390 1590 1863
Mecanismo traslación grúa / Crane travelling mechanism Mécanisme de translation de la grue / Механизм перемещения крана / Yürüyüş mekanizmalı vinç / آلية رفع الرافعة				0,96	0,56	0,66	293
Lastre / Ballast / Lest / Балласт / Alt ağırlık taşları / ثقل	□ 2,8m □ 3,8m - □4,5m BE 442 BE 434			3,00 4,00 2,09 3,40	0,44 0,34 0,34 0,34	1,30 1,30 2,10 1,69	3700 4100 3450 4300
Torre de montaje / Jacking cage / Tour de montage / Монтажная башня / Kaldırma kafesi / برج التركيب				7,14	1,76	1,71	3200
Torre de montaje sin puerta, carro, plataforma carro y viga de apoyo Jacking cage without door, trolley, trolley platform and beam assembly Tour de montage sans porte, chariot, plateforme de chariot et poutre de soutien Монтажная башня без двери, грузовой тележки, платформы грузовой тележки и опорной балки Kapisız kaldırma kafesi, vinç köprüsü arabası, vinç köprüsü arabası platformu ve giriş takımı برج التركيب بدون بوابة ، وعربة ومنصة متحركة وعارضة تدعيم		TMU 1.18 		7,14	1,76	1,71	2450

T	H								H	T	
1	4,5	TN 4							146.32.000	4,5	1
2	8,5	TN 4							146.31.000	8,5	2
3	20,3	TN 12							146.30.000	20,3	3
4	32,2	TR 12							146.30.800	32,2	4
5	40,1	TR 8M							202.36.500	40,1	5
6	43,9	TX-90/TXXR							133.32.000	43,9	6
7	46,8	T 3-90								46,8	7
8	49,8	T6-150A							161.31.300	52,6	8
9	52,7	T6-150							161.31.000	58,5	9
		AN 90	133.21.000						161.36.000	62,4	10
		AN 90	133.21.800						161.36.000	62,4	10
		AN 150	161.21.000						161.36.000	62,4	10
		AND 150	161.21.050						161.36.000	62,4	10
		AL 20	153.21.800						161.36.000	62,4	10
		ALD 20	160.21.250						161.36.000	62,4	10
		AS 20	160.21.010						161.36.000	62,4	10
		ASD 20/24	160.21.080						161.36.000	62,4	10
		ASR 20	160.21.200						161.36.000	62,4	10
		ASRD 20/24	156.21.000						161.36.000	62,4	10
		T6-150A	55,7	9					161.31.300	52,6	8
		T6-150	61,5	10					161.31.000	58,5	9
		TN 2	2,16	1					146.32.000	4,5	1
		TN 4	3,96	2					146.31.000	8,5	2
		TN 12	11,88	3					146.30.000	20,3	3
		TR 12	11,88	4					146.30.000	32,2	4
		TR 8M	7,86	5					146.30.800	40,1	5
		TX-90/TXXR	0,83	6					202.36.500	40,1	5
		T 3-90	2,95	7					133.32.000	43,9	6
		T6-150A	5,82	8					161.31.300	52,6	8
		T6-150	3,93	9					161.31.000	58,5	9
		TL20/TX150	5,6	10					161.36.000	62,4	10
		TL20-5,6	5,6	11					161.36.000	62,4	10
		TS20-5,6A	5,6	12					161.36.000	62,4	10
		TS20-5,6	5,6	13					161.36.000	62,4	10
		TSR20-5,6A	5,6	14					161.36.000	62,4	10
		TSR20-5,6	5,6	14					161.36.000	62,4	10

AN 90 133.21.000
 AN 90 133.21.800
 AN 150 161.21.000
 AND 150 161.21.050
 AL 20 153.21.800
 ALD 20 160.21.250
 AS 20 160.21.010
 ASD 20/24 160.21.080
 ASR 20 160.21.200
 ASRD 20/24 156.21.000

H - 2 m.

T: Torre / Tower / Tour / Башни / Kuleler / أبراج
 H: Altura / Height / Hauteur / Высота / Yükseklik / ارتفاع

Transporte
 Transport / Transport /
 Транспортировка / Taşıma /
 نقل

H=38,4 + AN12

2x

3x **HIGH CUBE 40'**

≤ 6xTN4

h (m)	36
D (m)	9,1 - 10
P (KN)	342 / 317
Rmax (KN)	92 / 250

h_{max}: 3xTR4 + 6xTN4

TR4: 800.32.300

H < 200 m

1,56
1,31
0,9

D
R
P

Trepado interno / Internal climbing. / Téléscopage intérieur / Внутренняя лестница /
 Bina içi tırmanma / التسلق الداخلي

- Viento fuera de servicio / Out of service wind / Vitesse du vent hors service / Ветровая нагрузка в покое / Rüzgar devre dışı / الريح خارج الخدمة
- Consultar / Consult / Nous consulter / Консультируйтесь / Danışınız / الرجوع إلى
- En servicio / In service / En service / В работе / Devrede / في الخدمة
- Fuera de servicio / Out of service / Hors service / В покое / Devre dışı / خارج الخدمة



Ctra./Rd. Madrid - Irún Km. 415 - 20.213 IDIAZABAL [Gipuzkoa] ESPAÑA / SPAIN
 P.O. Box, 23 - 20.200 BEASAIN - E-mail: jaso@jaso.com
 Tel. +34 943 - 18 70 00 • Fax. +34 943 - 18 70 20
www.jaso.com

Fecha / Date: 20/01/2016

FEM 1005 - C25

DELEGACION / DEALER

Reservado el derecho a modificaciones sin previo aviso. Declinamos toda responsabilidad derivada de la información proporcionada / Subject to modification, without previous warning. This information is supplied without liability / L'entreprise se réserve le droit de procéder à des modifications sans préavis. Nous déclinons toute responsabilité quant aux informations fournies / Мы оставляем за собой право на внесение изменений без предварительного уведомления. Мы снимаем с себя любую ответственность в отношении предоставленной информации / Önceden bildirilmesizin değiştirilme hakkı saklıdır. Verilen bilgiler için hiçbir sorumluluk kabul etmemekteyiz /