

Máxima altura de torre sin arriostrar (m). Maximum tower height without fastening (m). Hauteur maximale de tour sans ancrage (m). Максимальная высота башни без крепления (м). Desteksiz maksimum kule yüksekliği (m) أقصى ارتفاع للبرج بدون ربط (م)	H =	*Tramo pluma I / Jib section I ---- 211.40.000	BSI6-20-5,6 ----- 211.20.300
		*Tramo pluma II / Jib section II --- 211.41.000	BSI8-20-5,6 ----- 211.20.000
		*Tramo pluma III / Jib section III-- 211.42.000	TS 20 ----- 153.31.600
		*Tramo pluma IV / Jib section IV- 211.43.000	TS 20-5,6 ----- 204.31.200
		*Tramo pluma V / Jib section V--- 211.44.000	AS 20 ----- 160.21.010
		*Tramo pluma VI / Jib section VI- 211.45.000	ASR20----- 160.21.200
		*Tramo pluma VII / Jib section VII 211.46.000	ABH 100 ----- 201.23.000
		**Punta pluma VIII/ Jib end VIII--- 207.46.000	TM 20PAL-5,6----- 166.35.500
* Tramo pluma / Jib section / Tronçon de flèche / Секция стрелы / Bom bölümü / أجزاء الذراع			
** Punta de pluma / Jib end / Pointe de flèche / Конец стрелы / Bom ucu / مقدمة الذراع			

Fecha / Date: 01/09/2017

FEM 1005 - C25



Reservado el derecho a modificaciones sin previo aviso. Declinamos toda responsabilidad derivada de la información proporcionada / Subject to modification, without previous warning. This information is supplied without liability / L'entreprise se réserve le droit de procéder à des modifications sans préavis. Nous déclinons toute responsabilité quant aux informations fournies / Мы оставляем за собой право на внесение изменений без предварительного уведомления. Мы снимаем с себя любую ответственность в отношении предоставленной информации / Önceden bildirilmeksizin değiştirilme hakkı saklıdır. Verilen bilgiler için hiçbir sorumluluk kabul etmemekteyiz. حقوق التغيير محفوظة دون إشعار مسبق. دون أدنى مسؤولية عن المعلومات المقدمة

(H) TRASLACIÓN / TRAVELLING /

TRASLACION / ПЕРЕМЕЩЕНИЕ / RAY YÜRÜYÜŞLÜ / متحركة

(H) ESTACIONARIA / STATIONARY /

STATIONAIRE / СТАЦИОНАРНОЕ СОСТОЯНИЕ / SABIT / ثابتة

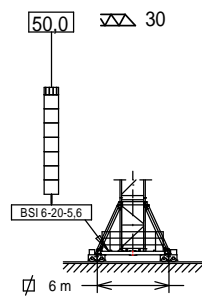

▽△	H(m)	□	■
30	50,0	7	1
35	46,1	7	-
40	44,4	6	1
45	44,4	6	1
50	40,5	6	-
55	38,9	5	1
60	35	5	-

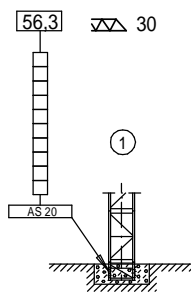

▽△	H(m)	□	■
30	56,3	10	-
35	54,6	9	1
40	50,7	9	-
45	50,7	9	-
50	49	8	1
55	45,1	8	-
60	43,4	7	1

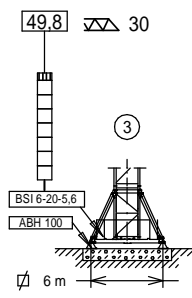

▽△	H(m)	□	■
30	49,8	7	1
35	46,0	7	-
40	44,2	6	1
45	44,2	6	1
50	40,4	6	-
55	38,7	5	1
60	34,8	5	-

- TS 20
- TS 20-5,6
- ▨ TSR 20-5,6A
- ⊠ TSR 20-5,6

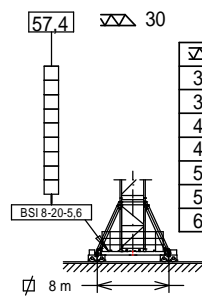

▽△	H(m)	□	■
30	57,4	9	-
35	55,6	8	1
40	51,7	8	-
45	51,7	8	-
50	50,0	7	1
55	46,1	7	-
60	44,4	6	1

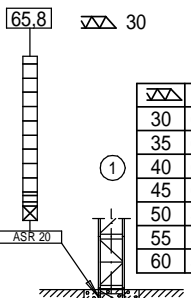

▽△	H(m)	⊠	▨	□	■
30	65,8	1	1	9	1
35	61,9	1	1	9	-
40	61,9	2	1	8	-
45	60,2	1	1	8	1
50	56,3	1	1	8	-
55	56,3	2	1	7	-
60	54,6	2	1	6	1

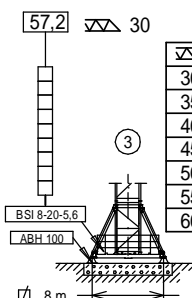

▽△	H(m)	□	■
30	57,2	9	-
35	55,4	8	1
40	51,6	8	-
45	51,6	8	-
50	49,9	7	1
55	46,0	7	-
60	44,2	6	1

TREPADO / CLIMBING / TÉLESCOPAGE / ЛЕСТНИЦА / TIRMANMA / التسلق

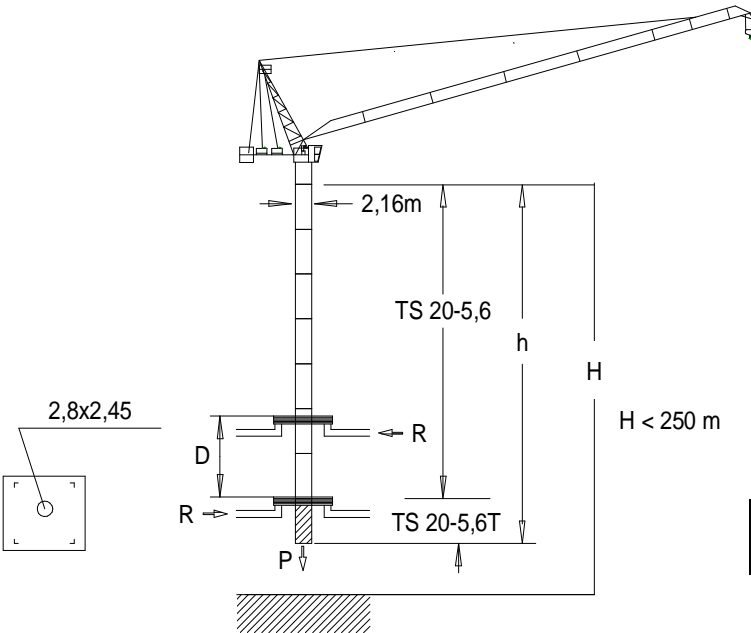

$h_{max} = TS\ 20-5,6T + 5 \times TS\ 20-5,6$

	▶	■
60 m.		
h (m)	33,9	
D (m)	15,2 - 17	
P (KN)	1062	942
Rmax (KN)	253	435

TS20-5,6T: 160.32.600

i Trepado interno / Internal climbing. / Téléscopage intérieur / Внутренняя лестница / Bina içi tirmanma / التسلق الداخلي



- 🚫 Viento fuera de servicio / Out of service wind / Vitesse du vent hors service / Ветровая нагрузка в покое / Rüzgar devre dışı / الرياح خارج الخدمة
- i** Consultar / Consult / Nous consulter / Консультируйтесь / Danışınız / الرجوع إلى
- ▶ En servicio / In service / En service / В работе / Devrede / في الخدمة
- Fuera de servicio / Out of service / Hors service / В покое / Devre dışı / خارج الخدمة











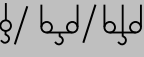
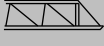



Fecha / Date: 01/09/2017

FEM 1005 - C25

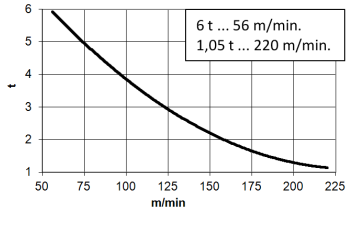
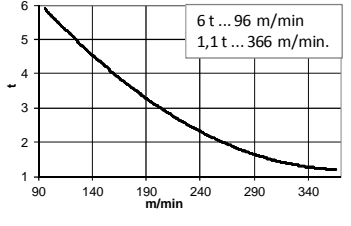
Reservado el derecho a modificaciones sin previo aviso. Declinamos toda responsabilidad derivada de la información proporcionada / Subject to modification, without previous warning. This information is supplied without liability / L'entreprise se réserve le droit de procéder à des modifications sans préavis. Nous déclinons toute responsabilité quant aux informations fournies / Мы оставляем за собой право на внесение изменений без предварительного уведомления. Мы снимаем с себя любую ответственность в отношении предоставленной информации / Önceden bildirilmeksizin değiştirilme hakkı saklıdır. Verilen bilgiler için hiçbir sorumluluk kabul etmemekteyiz / حقوق التغيير محفوظة دون إشعار مسبق. دون أدنى مسؤولية عن المعلومات المقدمة

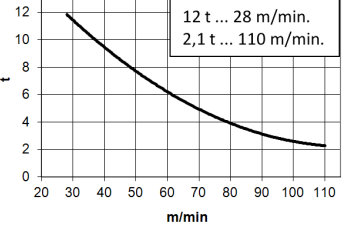
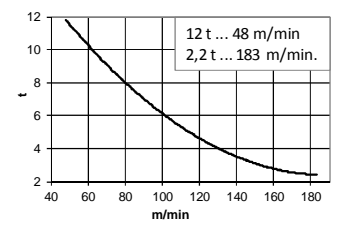
 TD [t]	TD 6t @ (m)	Cargas máximas / Maximum loads / Charges maximales / Максимальные нагрузки / Maksimum yük / أقصى حمولة TD – 6t							
		Alcance del gancho [m] / Hook reach [m] / Portée du crochet (m) / Радиус действия крюка (m) / Kancanın yüksekliği (m) / مدى الخطاف							
		25	30	35	40	45	50	55	60
60 m	41,5	6,0	6,0	6,0	6,0	5,1	3,9	3,0	2,2
55 m	42,6	6,0	6,0	6,0	6,0	5,4	4,3	3,3	—
50 m	43,2	6,0	6,0	6,0	6,0	5,5	4,4	—	—
45 m	43,8	6,0	6,0	6,0	6,0	5,7	—	—	—
40 m	40,0	6,0	6,0	6,0	6,0	—	—	—	—
35 m	35,0	6,0	6,0	6,0	—	—	—	—	—
30 m	30,0	6,0	6,0	—	—	—	—	—	—

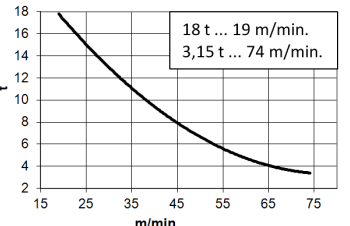
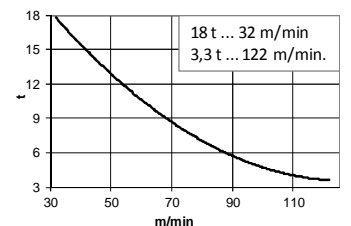
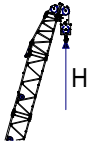
 TD/2R/3R [t]	3R 18t @...[m]	2R 12t @...[m]	TD 6t @...[m]	Cargas máximas / Maximum loads / Charges maximales / Максимальные нагрузки / Maksimum yük / أقصى حمولة TD/2R/3R - 6t/12t/18t								
				Alcance del gancho [m] / Hook reach [m] / Portée du crochet (m) / Радиус действия крюка (m) / Kancanın yüksekliği (m) / مدى الخطاف								
				20	25	30	35	40	45	50	55	60
60 m		27,5	41,0	12,0	12,0	10,5	8,1	6,3	4,9	3,8	2,8	2,0
55 m		27,9	42,0	12,0	12,0	10,7	8,4	6,6	5,2	4,1	3,1	—
50 m	20,9	28,1	42,6	18,0	14,2	10,9	8,5	6,8	5,4	4,2	—	—
45 m	20,9	28,2	43,1	18,0	14,2	11,0	8,7	6,9	5,5	—	—	—
40 m	21,1	28,6	40,0	18,0	14,4	11,2	8,9	7,1	—	—	—	—
35 m	21,1	28,8	35,0	18,0	14,5	11,3	9,0	—	—	—	—	—
30 m	21,3	29,1	30,0	18,0	14,7	11,5	—	—	—	—	—	—

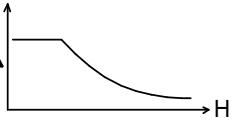
*opcional *optional *en option *опция *opsiyonel *اختياري	 EC88110VF 65 kW	* EC150185VF 110 kW	 TG2020VF 2x7,3 kW	 OG1507VF 2x5,5 kW	 EP6015VF 44,1 kW	 TH2006 15 kW						
	 <p>6 t ... 56 m/min. 1,05 t ... 220 m/min.</p>	 <p>6 t ... 96 m/min. 1,1 t ... 366 m/min.</p>	0...20 m/min	0...0,8 r/min sl/min	1,5 min	0,6 m/min						
	 <p>12 t ... 28 m/min. 2,1 t ... 110 m/min.</p>	 <p>12 t ... 48 m/min. 2,2 t ... 183 m/min.</p>	 400V 50Hz $P_{TOTAL} (EC88110VF + OG1507VF + EP6015VF) = 120,1 \text{ kW}$ $P_{TOTAL} (EC150185VF + OG1507VF + EP6015VF) = 165,1 \text{ kW}$									
	 <p>18 t ... 19 m/min. 3,15 t ... 74 m/min.</p>	 <p>18 t ... 32 m/min. 3,3 t ... 122 m/min.</p>	 <p>$H \leq$</p> <table border="0"> <tr> <td>TD</td> <td>630m</td> </tr> <tr> <td>2R</td> <td>315m</td> </tr> <tr> <td>3R</td> <td>210m</td> </tr> </table>   				TD	630m	2R	315m	3R	210m
TD	630m											
2R	315m											
3R	210m											

DENOMINACIÓN / DENOMINATION / DÉSIGNATION / НАЗВАНИЕ / AÇIKLAMA / اسم		L [m]	A [m]	H [m]	P / W [kg]	
Torre inferior / Lower tower Tour inférieure / Нижняя башня Alt kule / البرج السفلي	TSI20-5,6		5,966	2,328	2,390	5390
Torre / Tower Tour Башня / Kule / برج	TS20 TS20-5,6 TSR20-5,6A TSR20-5,6 TR24-5,6		4,236 5,966 5,926 5,990 5,990	2,335 2,328 2,388 2,257 2,760	2,348 2,390 2,325 2,257 2,835	2690 3550 4170 4210 4760
Torre asiento pista, base punta torre y orientación Slewing table, tower head base and slewing mechanism Tour pivot + base du porte-flèche + mécanisme d'orientation Сиденье площадки + основание верхней секции башни + поворотный механизм Döner tabla+kule kafa bölümü tabanı+mekanizma برج وحدة الدوارن + قاعدة رأس البرج + آلية الدوران			5,918	2,675	3,085	9900
Punta de torre + pasteca Tower head +reeving block Structure de porte-flèche + moufle et fléchette			11,663	1,910	2,033	6000
Tramo de pluma Jib section Tronçon de flèche Секция стрелы Вом bölümü أجزاء الذراع	(I) (II) (III) (IV) (V) (VI) (VII)		9,250 10,200 10,200 10,200 10,200 5,310 5,293	2,090 1,266 1,266 1,266 1,266 1,266 1,266	1,770 1,604 1,597 1,577 1,577 1,577 1,630	1580 1490 1373 1225 1171 682 926
Punta de pluma / Jib end Pointe de flèche / Конец стрелы / Вом ucu / مقدمة الذراع			3,420	1,580	3,585	880
Polipasto / Hook assembly Palan / Полиспаст / Канса takımı / بكرة			0,918	0,394	1,218	440
Tirante sostén pluma / Jib support tie / Tirant de fleche / Растяжка поддержки стрелы / Kol destek bağları مشد دعامة الذراع			5,842	0,360	0,370	1115
Estructura contrapluma / Counterjib structure Structure de contre-flèche / Структура противовесной консоли / Denge kolunun yapısı المعاكس هيكل الذراع			7,765	1,925	0,725	1437
Contrapluma con mecanismos / Counterjib with mechanisms / Contre-flèche avec mécanismes / Противовесная консоль с механизмами / Mekanizmalı denge kolu الذراع المعاكس مع الآليات			7,765	2,230	2,390	11800
Plataforma y cabina / Platform and cabin / Plateforme et cabine / Платформа и кабина / Platform ve kabin / منصة وكابينة			3,420	2,060	2,400	1095
Mecanismos Mechanisms Mécanismes de Механизмы Mekanizmalar اليات كهربائية	Elevación carga / Hoisting / levage de charge / Подъем груза / Yük kaldırma/ رافع الحمولة Elevación pluma / Luffing / Relevage de flèche / Подъем стрелы / Yük kaldırma ve indirme / رافع الذراع		2,372 1,967	2,062 2,631	2,077 1,895	6200 3200
Transporte torre de montaje/ Jacking cage transport / Transport de tour de montage / Транспортировка монтажной башни / Kaldırma kafesinin taşınması / نقل برج التركيب	TM 20PAL-5,6		9,550	2,070	2,520	5,690

Fecha / Date: 01/09/2017

FEM 1005 - C25



Reservado el derecho a modificaciones sin previo aviso. Declinamos toda responsabilidad derivada de la información proporcionada / Subject to modification, without previous warning. This information is supplied without liability / L'entreprise se réserve le droit de procéder à des modifications sans préavis. Nous déclinons toute responsabilité quant aux informations fournies / Мы оставляем за собой право на внесение изменений без предварительного уведомления. Мы снимаем с себя любую ответственность в отношении предоставленной информации / Önceden bildirilmeksizin değiştirilme hakkı saklıdır. Verilen bilgiler için hiçbir sorumluluk kabul etmemekteyiz / حقوق التغيير محفوظة دون إشعار مسبق. دون أدنى مسؤولية عن المعلومات المقدمة

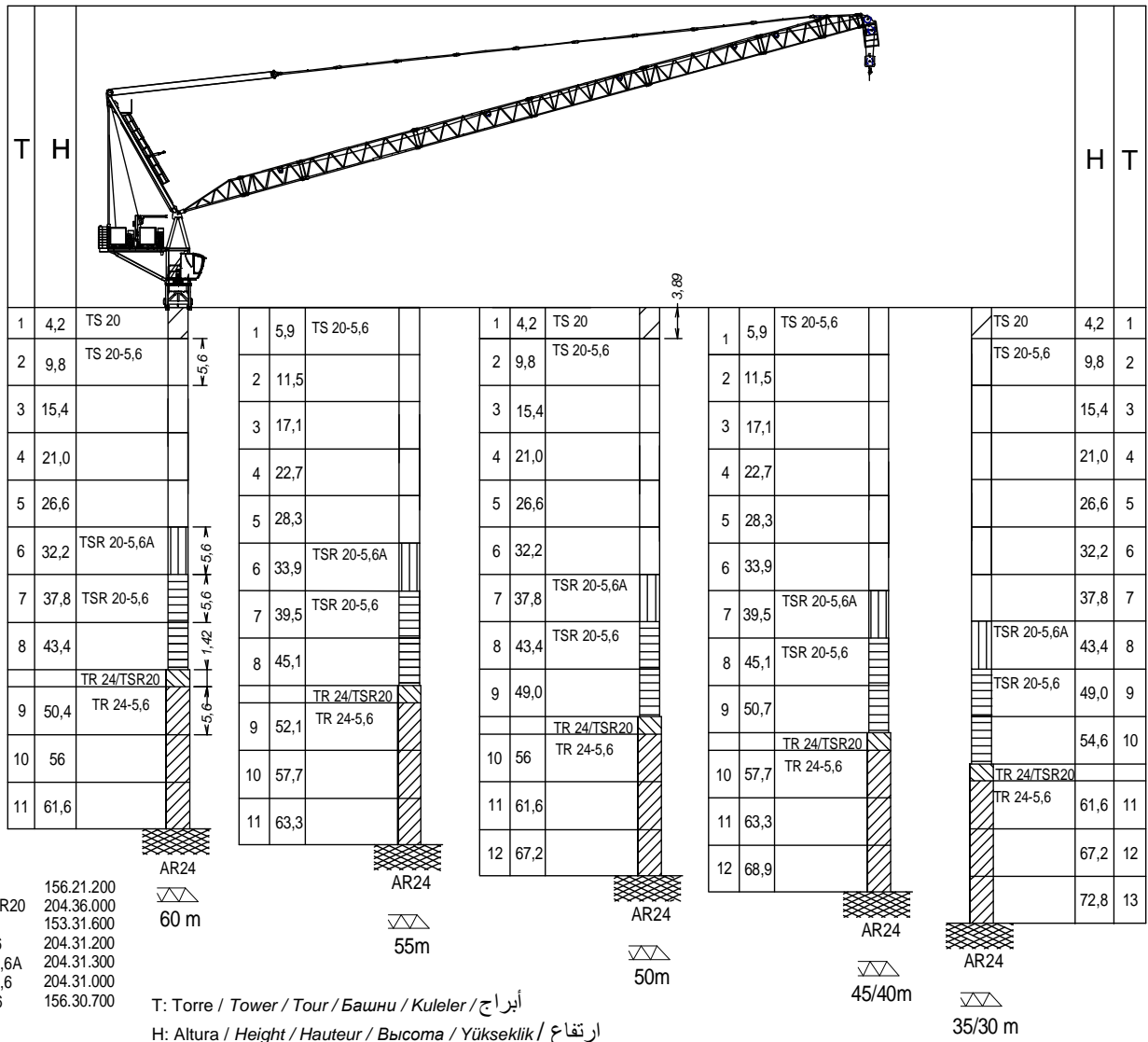

T: Torre / Tower / Tour / Башни / Kuleler / أبراج
 H: Altura / Height / Hauteur / Высота / Yükseklik / ارتفاع



Otras configuraciones de torre
 Other tower configuration / Autres configurations / Прочие конфигурации / Diğer konfigürasyonlar / مكونات أخرى

TRANSPORTE / TRANSPORT / TRANSPORT / ТРАНСПОРТИРОВКА / TAŞIMA | نقل

J265PA

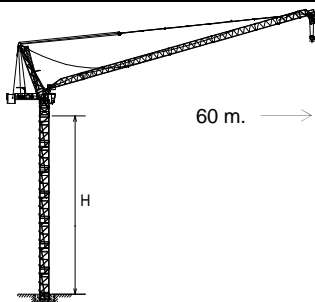

H = 43,4 m + AS20

8 x



7 x

HIGH CUBE 40'

+ 1 x

FLAT RACK 40'

Ancho 2,4m wide



Ctra./Rd. Madrid - Irún Km. 415 - 20.213 IDIAZABAL [Gipuzkoa] ESPAÑA / SPAIN
 P.O. Box, 23 - 20.200 BEASAIN - E-mail: jaso@jaso.com
 Tel. +34 943 - 18 70 00 • Fax. +34 943 - 18 70 20
 www.jaso.com

Fecha / Date: 01/09/2017



FEM 1005 - C25

DELEGACION / DEALER

Reservado el derecho a modificaciones sin previo aviso. Declinamos toda responsabilidad derivada de la información proporcionada / Subject to modification, without previous warning. This information is supplied without liability / L'entreprise se réserve le droit de procéder à des modifications sans préavis. Nous déclinons toute responsabilité quant aux informations fournies / Мы оставляем за собой право на внесение изменений без предварительного уведомления. Мы снимаем с себя любую ответственность в отношении предоставленной информации / Önceden bildirilmeksizin değiştirilme hakkı saklıdır. Verilen bilgiler için hiçbir sorumluluk kabul etmemekteyiz /

حقوق التغيير محفوظة دون إشعار مسبق دون أدنى مسؤولية عن المعلومات المقدمة