

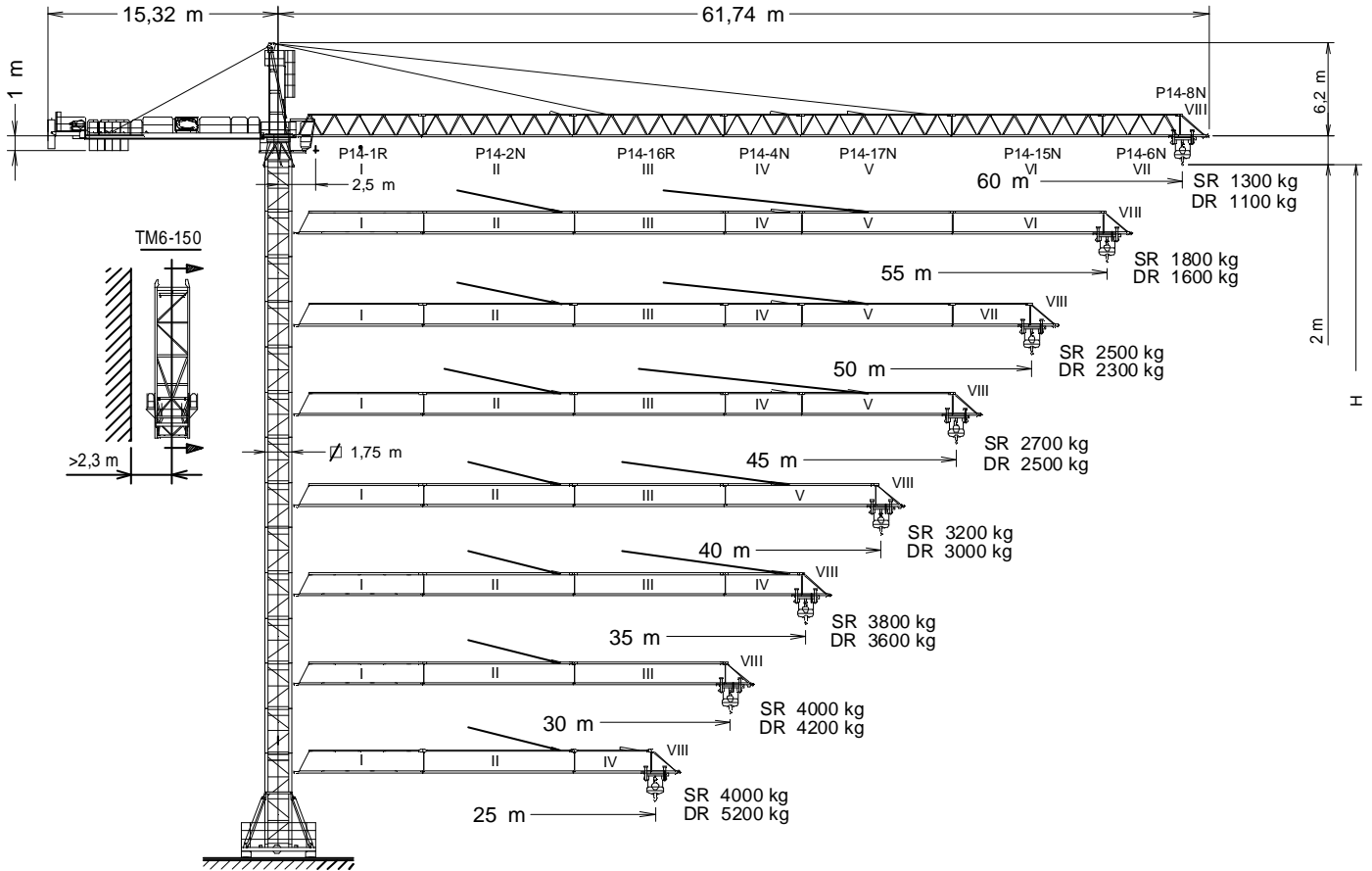

EN 14439
C25

UNE-EN-ISO 9001



H_{SR} =

Altura máxima bajo gancho sin arriostrar (m).
Maximum height under hook without fastening (m).
Hauteur maximale sous crochet sans ancrage (m).
Максимальная высота под крюком без крепления (m).
Bağlantısız maksimum kanca altı yüksekliği (m).
أقصى ارتفاع تحت الخطاف بدون ربط (m)

TM 6-150	161.35.700	ABH 100	201.23.000
T3-90	133.32.000	P14-1R	145.40.500
T6-90	133.31.000	P14-2N	145.41.500
T6-150	161.31.000	P14-16R	145.42.800
T6-150A	161.31.300	P14-4N	145.43.000
AN 90	133.21.000	P14-17N	145.44.500
AN 150	161.21.000	P14-15N	145.45.500
BNI 45-100	145.20.500	P14-6N	145.45.000
BNI 6-150	161.20.700	P14-8N	145.47.500

(H) TRASLACIÓN / TRAVELLING /

TRASLATION / ПЕРЕМЕЩЕНИЕ / RAY YÜRÜYÜŞLÜ / متحركة

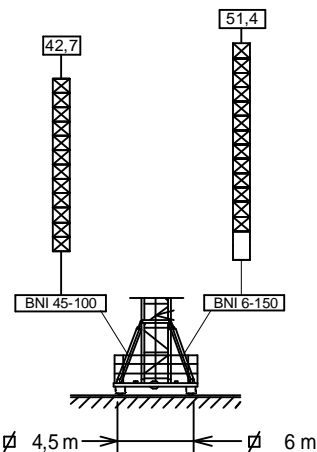

(H) ESTACIONARIA / STATIONARY /

STATIONAIRE / СТАЦИОНАРНОЕ СОСТОЯНИЕ / SABIT / ثابتة

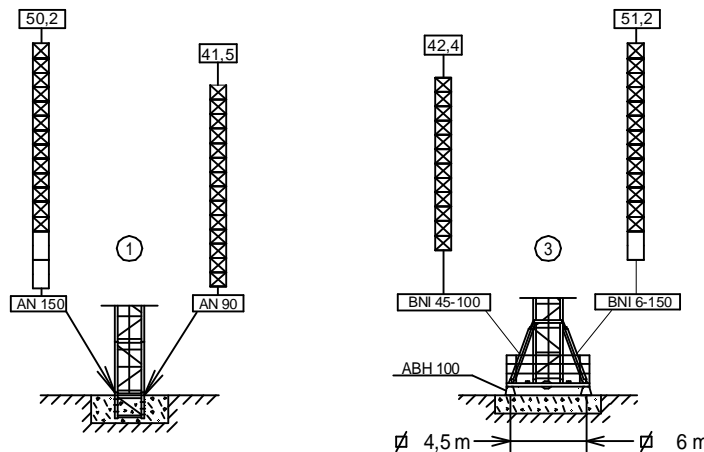

- T 3-90
- T 6-90
TD 6-90
- T6-150A
- T6-150
TD6-150

Fecha / Date: 20/10/2016

FEM 1005 - C25















Reservado el derecho a modificaciones sin previo aviso. Declinamos toda responsabilidad derivada de la información proporcionada / Subject to modification, without previous warning. This information is supplied without liability / L'entreprise se réserve le droit de procéder à des modifications sans préavis. Nous déclinons toute responsabilité quant aux informations fournies / Мы оставляем за собой право на внесение изменений без предварительного уведомления. Мы снимаем с себя любую ответственность в отношении предоставленной информации / Onceden bildirilmeksizin değiştirilme hakkı saklıdır. Verilen bilgiler için hiçbir sorumluluk kabul etmemekteyiz / حقوق التغيير محفوظة دون إشعار مسبق. دون أدنى مسؤولية عن المعلومات المقدمة

ST-SR (kg)		Cargas máximas / Maximum loads / Charges maximales / Максимальные нагрузки / Maksimum yük / أقصى حمولة SR-4.000 kg							
[m]	4000 kg @ ... (m)	Alcance del gancho [m] / Hook reach [m] / Portée du crochet (m) / Радиус действия крюка (m) / Kancanın yüksekliği (m) / مدى الخطاف							
		25	30	35	40	45	50	55	60
60 m	25,5 m	4000	3290	2720	2295	1960	1695	1480	1300
55 m	29,2 m	4000	3875	3220	2730	2350	2045	1800	—
50 m	29,2 m	4000	3900	3400	3025	2735	2500	—	—
45 m	32,5 m	4000	4000	3665	3120	2700	—	—	—
40 m	33,2 m	4000	4000	3755	3200	—	—	—	—
35 m	33,5 m	4000	4000	3800	—	—	—	—	—
30 m	30,0 m	4000	4000	—	—	—	—	—	—
25 m	25,0 m	4000	—	—	—	—	—	—	—

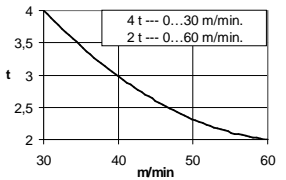
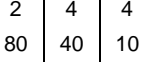
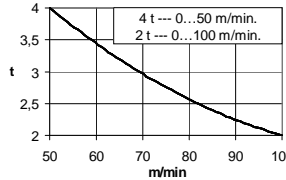
ST-DR (kg)		Cargas máximas / Maximum loads / Charges maximales / Максимальные нагрузки / Maksimum yük / أقصى حمولة DR - 8.000 kg									
[m]	8000 kg @ ... (m)	Alcance del gancho [m] / Hook reach [m] / Portée du crochet (m) / Радиус действия крюка (m) / Kancanın yüksekliği (m) / مدى الخطاف									
		15	20	25	30	35	40	45	50	55	60
60 m	13,7 m	7225	5180	3955	3140	2555	2120	1780	1505	1285	1100
55 m	15,6 m	8000	6045	4650	3715	3050	2550	2165	1850	1600	—
50 m	15,6 m	8000	6175	4885	4025	3410	2945	2585	2300	—	—
45 m	17,3 m	8000	6800	5250	4220	3480	2930	2500	—	—	—
40 m	17,6 m	8000	6940	5365	4310	3560	3000	—	—	—	—
35 m	17,8 m	8000	7005	5415	4355	3600	—	—	—	—	—
30 m	17,3 m	8000	6770	5225	4200	—	—	—	—	—	—
25 m	17,2 m	8000	6735	5200	—	—	—	—	—	—	—

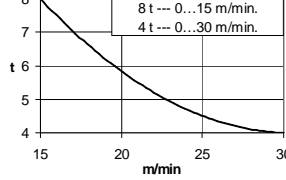
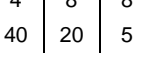
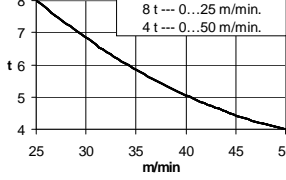
CARACTERISTICAS DE MECANISMOS / MECHANISMS FEATURES / CARACTÉRISTIQUES DES

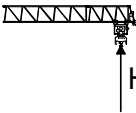
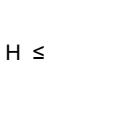
MÉCANISMES / ХАРАКТЕРИСТИКИ МЕХАНИЗМОВ / MEKANİZMALARIN ÖZELLİKLERİ / الخصائص الآلية

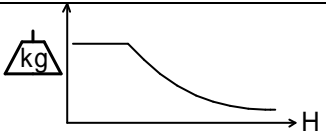
*opcional / *optional / en option / *опция / *opsiyonel / اختياري							
	EC3360VF 24,3 kW	*EC4880 35,3 kW	*EC60100VF 44,1 kW	TG1125VF 2x4 kW	OG1508VF 2x5,5 kW	TC465VF 3 kW	TH1210 9,2 kW
 t m/min				0...25 m/min	0...0,8 r/min sl/min	0...15 15...32 32...65 m/min	1 m/min
 t m/min				 400V 50Hz	P_{TOTAL}(EC3360VF+ OG1508VF + TC465VF) = 38,3 kW P_{TOTAL}(EC4880+ OG1508VF + TC465VF) = 49,3 kW P_{TOTAL}(EC60100VF+ OG1508VF + TC465VF) = 58,1 kW		
	 H ≤ SR 322 m DR 161 m	 H ≤ SR 534 m DR 267 m					

DENOMINACIÓN / DENOMINATION / DÉSIGNATION / НАЗВАНИЕ / AÇIKLAMA / اسم		L [m]	A [m]	H [m]	P / W [kg]	
Torre inferior / Lower tower / Tour inférieure / Нижняя башня Alt kule / البرج السفلي	T16-90 T16-150		6,146 6,175	2,085 2,190	2,085 2,190	2500 3535
Torre / Tower / Tour Башня / Kule / برج	T3-90 T6-90 T6-150A T6-150		3,190 6,140 6,175 6,175	1,818 1,818 1,870 1,870	1,818 1,818 1,870 1,870	1200 2250 2760 2760
Torre asiento pista + base punta de torre + orientación Slewing table + tower head base + slewing mechanism Tour pivot + base du porte-flèche + mécanisme d'orientation Сиденье площадки + основание верхней секции башни + поворотный механизм Göbek +kule kafa bölümü tabanı+mekanizma برج وحدة الدوارن + قاعدة رأس البرج + آلية الدوران			3,390	2,060	2,150	3700
Punta de torre / Tower head / Porte-flèche верхняя секция башни / kulenin kafa bölümü / رأس البرج			6,090	1,915	1,930	1700
Conjunto asiento pista, punta de torre, orientación y elevación Slewing table assembly, tower head, slewing and hoisting mechanism Groupe pivot + porte-flèche + mécanisme d'orientation + de levage Сиденье площадки + верхняя секция башни + поворотный механизм + подъемный механизм Göbek +kulenin kafa bölümü+mekanizma+vinç kulesi مجموعة وحدة الدوارن + رأس البرج + آلية الدوران + آلية الرفع			8,370	2,615	2,720	5400
Tramo de pluma Jib section Tronçon de flèche Секция стрелы Вот bölümü أجزاء الذراع	P14-1R (I) P14-2N (II) P14-16R (III) P14-4N (IV) P14-17N (V) P14-15N (VI) P14-6N (VII) P14-8N (VIII)		8,665 10,160 10,160 5,270 10,160 10,160 5,270 2,095	1,366 1,226 1,226 1,226 1,226 1,226 1,226 1,366	1,698 1,630 1,630 1,630 1,630 1,550 1,545 1,740	1030 1150 1140 495 695 695 323 195
Polipasto / Hook assembly / Palan / Полуспаст / Kanca takımı / بكرة	SR/DR		1,420	0,500	1,000	400
Tirante sostén pluma / Jib support tie / Tirant de fleche / Растяжка поддержки стрелы / Kol destek bağları / مشد دعامة الذراع	Largo / Long / Corto / Short		5,30 4,90	0,70 0,445	1,750 1,750	650 450
Carro / Trolley / Chariot / Грузовая тележка / Şaryo / عربة	SR/DR		2,005	1,665	1,525	390
Contrapluma con plataformas / Counterjib with platforms Contre-flèche avec plateformes / Противовесная консоль с платформами / الذراع المقابل مع المنصة			11,950	1,490	0,709	2495
Soporte y elevación / Support and hoisting / Support et levage / Опора и подъем / Destek ve vinç kulesi / دعم ورفع	EC3360VF EC4880 EC60100VF		2,655 2,655 2,655	2,315 2,315 2,315	1,750 1,750 1,750	2160 2480 2625
Plataforma y cabina / Platform and cabin / Plateforme et cabine Платформа и кабина / Platform ve kabin / منصة وكابينة			3,760	2,050	2,400	1280
Contrapeso / Counterweight / Contrepoids / Противовес / Denge ağırlığı / أوزان معاكسة	Grande / Big / Grand / Большой / Büyük / كبير Pequeño / Small / Petit / Малый / Küçük / صغير		1,080 1,080	0,500 0,500	2,025 1,305	2360 1500
Lastre / Ballast / Lest / Балласт / Alt ağırlık taşları / ثقل			3,800	0,580	1,500	6000
Estructura torre de montaje / Jacking cage structure / Structure de tour de montage / Структура монтажной башни / Kaldırma kafesi yapısı / هيكل برج التركيب	TM 6-150		10,320	2,420	2,310	3500

LASTRES INFERIORES / LOWER BALLASTS / LESTS INFÉRIEURS / НИЖНИЙ БАЛЛАСТ / ALT AĞIRLIK TAŞLARI / ثقل

BNI 45-100	H (m)	19,2	31	36,9	42,7
	P (t)	36	48	60	72
BNI 6-150	H (m)	25	36,8	42,7	51,4
	P (t)	36	48	60	96

H: Altura bajo gancho / Height under hook / Hauteur maximale sous crochet Высота под крюком / Kanca alti yüksekliği / الارتفاع أسفل الخطاف
Para alturas intermedias tomar el lastre correspondiente a la altura superior / For intermediate heights take the ballast corresponding to the higher height / Pour les hauteurs intermédiaires, opter pour le lest correspondant à la hauteur immédiatement supérieure / Для промежуточных высот возьмите балласт, соответствующий большей высоте / Orta yükseklikler için daha üst bir yüksekliğe karşılık gelen ağırlığı alınız. / لارتفاعات البينية يرجى استخدام الثقل العائد للارتفاع الأعلى / حقوق التغيير محفوظة دون إشعار مسبق. دون أدنى مسؤولية عن المعلومات المقدمة



Fecha / Date: 20/10/2016

FEM 1005 - C25

Reservado el derecho a modificaciones sin previo aviso. Declinamos toda responsabilidad derivada de la información proporcionada / Subject to modification, without previous warning. This information is supplied without liability / L'entreprise se réserve le droit de procéder à des modifications sans préavis. Nous déclinons toute responsabilité quant aux informations fournies / Мы оставляем за собой право на внесение изменений без предварительного уведомления. Мы снимаем с себя любую ответственность в отношении предоставленной информации / Önceden bildirilmeksizin değiştirilme hakkı saklıdır. Verilen bilgiler için hiçbir sorumluluk kabul etmemekteyiz / حقوق التغيير محفوظة دون إشعار مسبق. دون أدنى مسؤولية عن المعلومات المقدمة

T	H											T	H
1	3,1											1	3,1
2	6,1											2	6,1
3	9											3	9
4	12											4	12
5	14,9											5	14,9
6	17,9											6	17,9
7	20,8											7	20,8
8	23,8											8	23,8
9	26,7											9	26,7
10	39,7											10	39,7
11	32,6											11	32,6
12	35,6											12	35,6
13	38,5											13	38,5
14	44,4	T6-150A										14	44,3
15	50,2	T6-150 161.31.000										15	48,3
16	54,1	AN 150	TL20/TX150 161.36.000									16	53,9
17	59,7		TL20-5,6 204.31.400									17	59,5
												18	65,1
												19	70,7
												20	76,3

T: Torre / Tower / Tour / Башни / Kuleler / أبراج
H: Altura / Height / Hauteur / Высота / Yükseklik / ارتفاع



Otras configuraciones de torre / Other tower configuration / Autres configurations / Прочие конфигурации / Diğer konfigürasyonlar / مكونات أخرى

Transporte
Transport / Transport /
Транспортировка / Taşıma / نقل

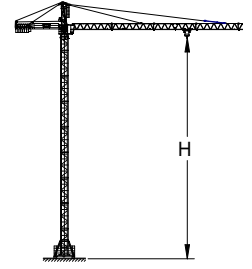

H=42,7; + BNI 45 100

6x

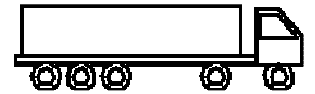

7x

HIGH CUBE 40'

TREPADO / CLIMBING / TÉLESCOPAGE / ЛЕСТНИЦА / TIRMANMA / التسلق

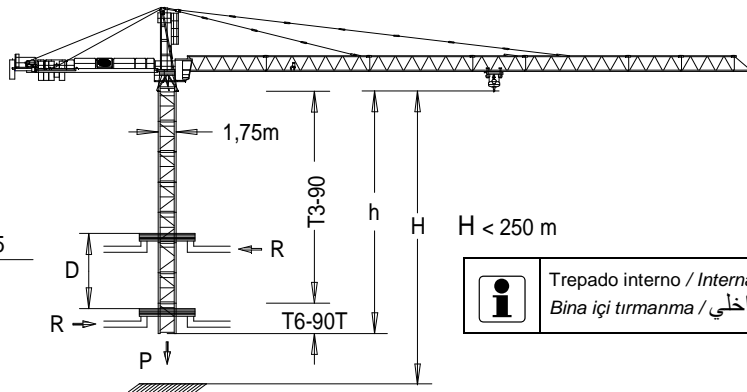

h_{max}: T6-90T + 11xT3-90

	▶	■
h (m)	39,1	
D (m)	15,8 - 20	
P (KN)	635	595
Rmax (KN)	99	200

T6-90T = 139.32.700



Trepado interno / Internal climbing. / Télescopage intérieur / Внутренняя лестница / Bina içi tirmanma / التسلق الداخلي



Viento fuera de servicio / Out of service wind / Vitesse du vent hors service / Ветровая нагрузка в покое / Rüzgar devre dışı / الريح خارج الخدمة



Consultar / Consult / Nous consulter / Консультируйтесь / Danışınız / الرجوع إلى



En servicio / In service / En service / В работе / Devrede / في الخدمة



Fuera de servicio / Out of service / Hors service / В покое / Devre dışı / خارج الخدمة



Ctra./Rd. Madrid - Irún Km. 415 - 20.213 IDIAZABAL [Gipuzkoa] ESPAÑA / SPAIN
P.O. Box, 23 - 20.200 BEASAIN - E-mail: jaso@jaso.com
Tel. +34 943 - 18 70 00 • Fax. +34 943 - 18 70 20
www.jaso.com

Fecha / Date: 20/10/2016



FEM 1005 - C25

DELEGACION / DEALER

Reservado el derecho a modificaciones sin previo aviso. Declinamos toda responsabilidad derivada de la información proporcionada / Subject to modification, without previous warning. This information is supplied without liability / L'entreprise se réserve le droit de procéder à des modifications sans préavis. Nous déclinons toute responsabilité quant aux informations fournies / Мы оставляем за собой право на внесение изменений без предварительного уведомления. Мы снимаем с себя любую ответственность в отношении предоставленной информации / Önceden bildirilmeden yapılan değişikliklerin hakkını saklıdır. Verilen bilgiler için hiçbir sorumluluk kabul etmemekteyiz /

حقوق التغيير محفوظة دون إشعار مسبق. دون أدنى مسؤولية عن المعلومات المقدمة