

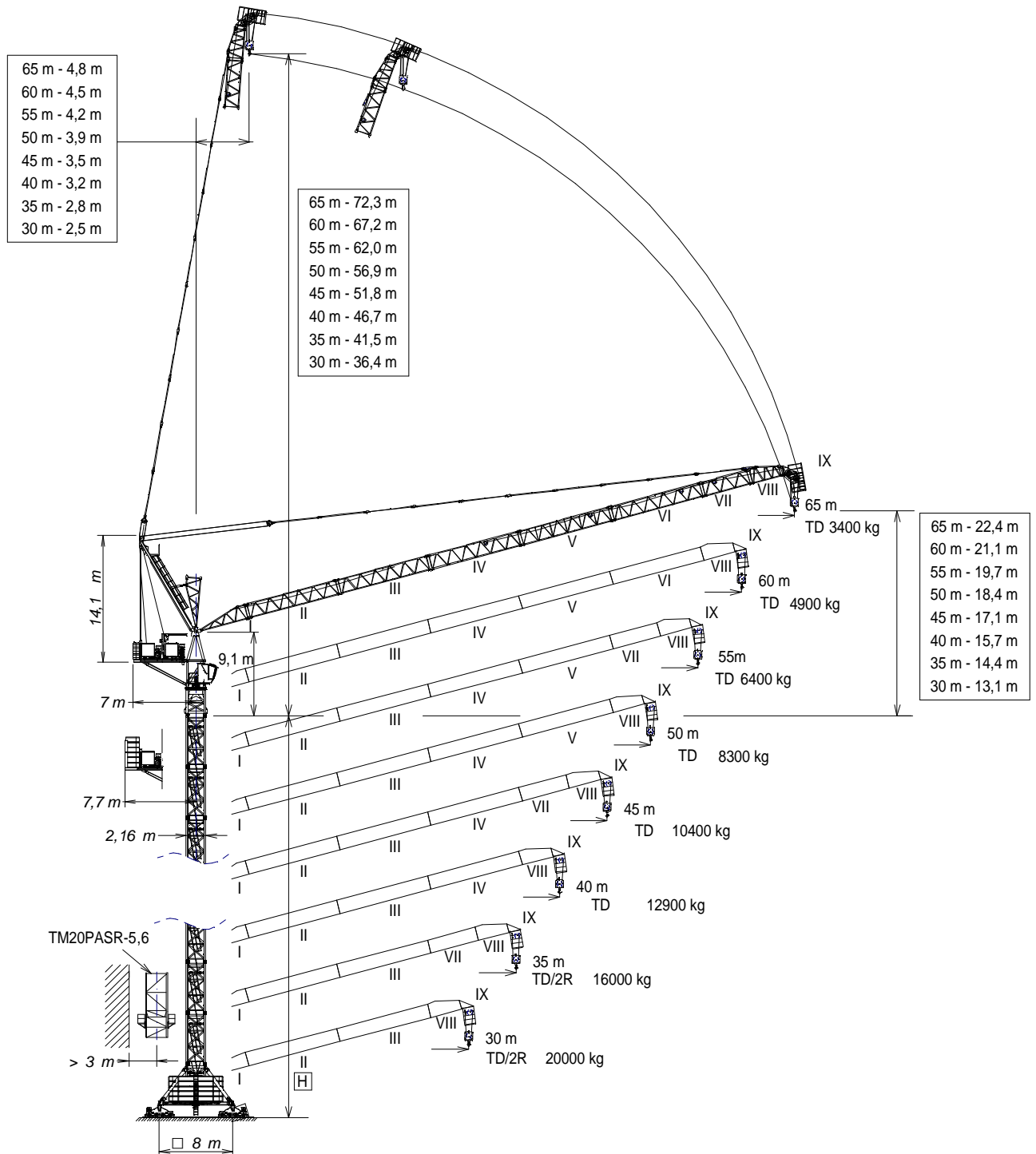

UNE 58-101
FEM 1001

UNE-EN-ISO 9001



Máxima altura de torre sin arriostrar (m).

Maximum tower height without fastening (m).

Hauteur maximale de tour sans ancrage (m).

H = Максимальная высота башни без крепления (m).

Desteksiz maksimum kule yüksekliği (m)

أقصى ارتفاع للبرج بدون ربط (م)

* Tramo pluma / Jib section / Tronçon de flèche /

Секция стрелы / Bom bölümü / أجزاء الذراع

*Tramo pluma I / Jib section I -----206.40.000

*Tramo pluma II / Jib section II-----212.41.000

*Tramo pluma III / Jib section III-----212.42.000

*Tramo pluma IV / Jib section IV-----212.43.000

*Tramo pluma V / Jib section V-----212.44.000

*Tramo pluma VI / Jib section VI-----212.45.000

*Tramo pluma VII / Jib section VII-----212.46.000

*Tramo pluma VIII / Jib section VIII-----206.47.000

*Tramo pluma IX / Jib section IX-----212.48.000

BSR18-20-5,6 -----204.20.000

ASR20 -----160.21.200

TSR20 -----153.31.800

TSR20-5,6 -----204.31.000

TM20PASR-5,6 -----206.35.000

ABH100B -----204.23.000

ABH100H -----156.23.500

Fecha / Date: 30/05/2018



Reservado el derecho a modificaciones sin previo aviso. Declinamos toda responsabilidad derivada de la información proporcionada / Subject to modification, without previous warning. This information is supplied without liability / L'entreprise se réserve le droit de procéder à des modifications sans préavis. Nous déclinons toute responsabilité quant aux informations fournies / Мы оставляем за собой право на внесение изменений без предварительного уведомления. Мы снимаем с себя любую ответственность в отношении предоставленной информации / Önceden bildirilmeksizin değiştirilme hakkı saklıdır. Verilen bilgiler için hiçbir sorumluluk kabul etmemekteyiz



TD

(H) TRASLACIÓN / TRAVELLING /

TRASLATION / ПЕРЕМЕЩЕНИЕ / RAY YÜRÜYÜŞLÜ / متحركة

(H) ESTACIONARIA / STATIONARY /

STATIONAIRE / СТАЦИОНАРНОЕ СОСТОЯНИЕ / SABIT / ثابتة

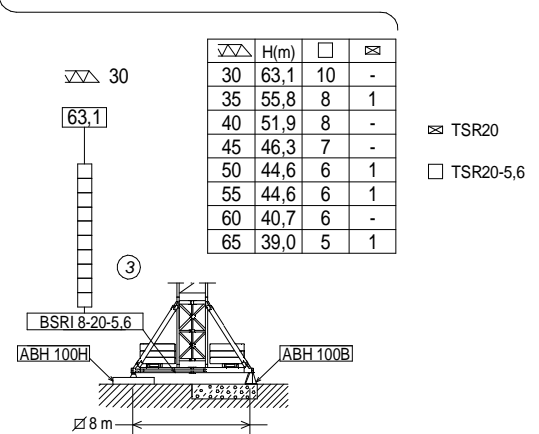
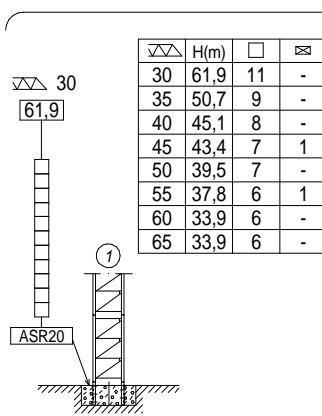
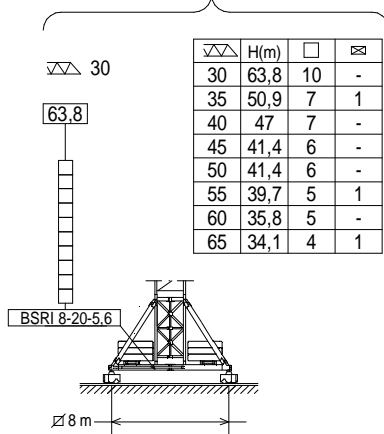

⊠ TSR20
□ TSR20-5.6

TD / 2R

(H) TRASLACIÓN / TRAVELLING /

TRASLATION / ПЕРЕМЕЩЕНИЕ / RAY YÜRÜYÜŞLÜ / متحركة

(H) ESTACIONARIA / STATIONARY /

STATIONAIRE / СТАЦИОНАРНОЕ СОСТОЯНИЕ / SABIT / ثابتة

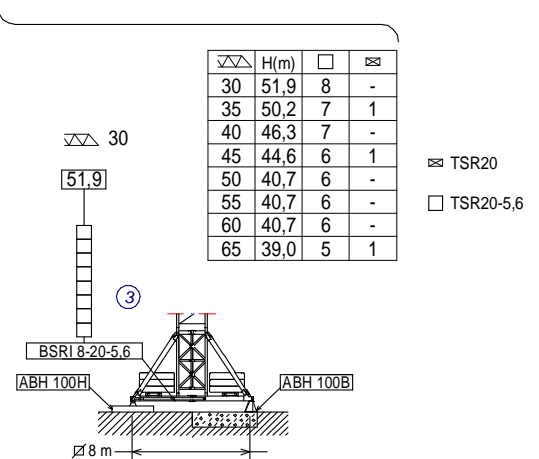
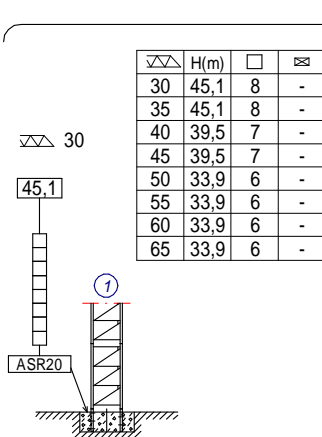
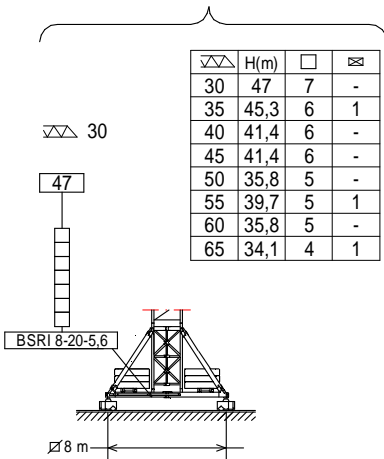

⊠ TSR20
□ TSR20-5.6

TREPADO / CLIMBING / TÉLESCOPAGE / ЛЕСТНИЦА / TIRMANMA / التسلق

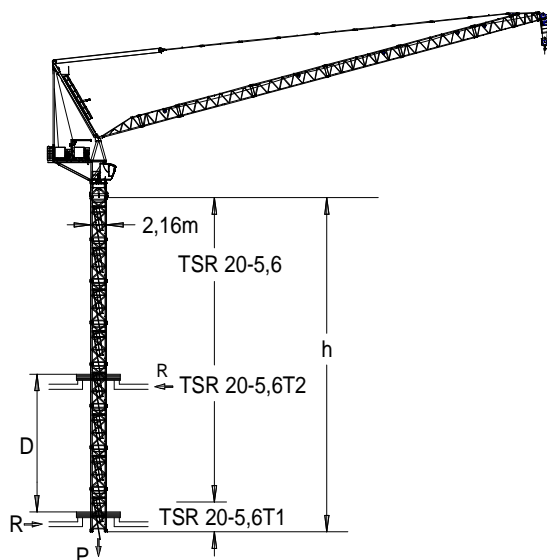

$h_{max} = \text{TSR20-5,6T1} + 5 \times \text{TSR20-5,6} + \text{TSR20-5,6T2}$

	50 m.	16 t	▶	■
h (m)	39,2			
D (m)	11,3 – 18			
P (KN)	1675	1515		
Rmax (KN)	555	625		

TSR20-5,6T1: 204.31.600
TSR20-5,6T2: 204.31.900



Trepado interno / Internal climbing. / Télescopage intérieur / Внутренняя лестница / Vına içi tirmanma / التسلق الداخلي

Fecha / Date: 30/05/2018

FEM 1001



Reservado el derecho a modificaciones sin previo aviso. Declinamos toda responsabilidad derivada de la información proporcionada / Subject to modification, without previous warning. This information is supplied without liability / L'entreprise se réserve le droit de procéder à des modifications sans préavis. Nous déclinons toute responsabilité quant aux informations fournies / Мы оставляем за собой право на внесение изменений без предварительного уведомления. Мы снимаем с себя любую ответственность в отношении предоставленной информации / Önceden bildirilmeksizin değiştirilme hakkı saklıdır. Verilen bilgiler için hiçbir sorumluluk kabul etmemekteyiz / حقوق التغيير محفوظة دون إشعار مسبق. دون أدنى مسؤولية عن المعلومات المقدمة

 TD (t)		Cargas máximas / Maximum loads / Charges maximales / Максимальные нагрузки / Maksimum yük / أقصى حمولة TD – 16 t									
 [m]	TD 16t @ (m)	Alcance del gancho [m] / Hook reach [m] / Portée du crochet (m) / Радиус действия крюка (m) / Kancanın yüksekliği (m) / مدى الخطاف									
		25	30	35	40	45	50	55	60	65	
65 m	33,9	16,0	16,0	15,2	12,0	9,6	7,6	6,0	4,6	3,4	
60 m	34,2	16,0	16,0	15,4	12,3	9,9	7,9	6,3	4,9	-	
55 m	34,6	16,0	16,0	15,7	12,6	10,1	8,1	6,4	-	-	
50 m	34,6	16,0	16,0	15,7	12,7	10,3	8,3	-	-	-	
45 m	34,8	16,0	16,0	15,8	12,8	10,4	-	-	-	-	
40 m	34,9	16,0	16,0	15,9	12,9	-	-	-	-	-	
35 m	35,0	16,0	16,0	16,0	-	-	-	-	-	-	
30 m	30,0	16,0	16,0	-	-	-	-	-	-	-	

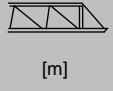
 TD/2R (t)			Cargas máximas / Maximum loads / Charges maximales / Максимальные нагрузки / Maksimum yük / أقصى حمولة TD/2R – 16/32 t									
 [m]	2R 32t @ (m)	TD 16t @ (m)	Alcance del gancho [m] / Hook reach [m] / Portée du crochet (m) / Радиус действия крюка (m) / Kancanın yüksekliği (m) / مدى الخطاف									
			20	25	30	35	40	45	50	55	60	65
65 m	33,4	16,0	16,0	16,0	16,0	14,8	11,7	9,2	7,2	5,6	4,2	3,0
60 m	33,7	16,0	16,0	16,0	16,0	15,0	11,9	9,5	7,5	5,9	4,5	-
55 m	33,7	16,0	16,0	16,0	16,0	15,1	12,0	9,6	7,6	6,0	-	-
50 m	20,7	34,1	32,0	25,0	19,4	15,3	12,3	9,9	7,9	-	-	-
45 m	20,7	34,2	32,0	25,0	19,5	15,4	12,4	10,0	-	-	-	-
40 m	20,7	34,3	32,0	25,0	19,5	15,5	12,5	-	-	-	-	-
35 m	20,8	35,0	32,0	25,5	20,0	16,0	-	-	-	-	-	-
30 m	20,8	30,0	32,0	25,5	20,0	-	-	-	-	-	-	-

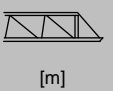
 [m]	2R 18t @ (m)	TD 9t @ (m)	Alcance del gancho [m] / Hook reach [m] / Portée du crochet (m) / Радиус действия крюка (m) / Kancanın yüksekliği (m) / مدى الخطاف									
			25	30	35	40	45	50	55	60	65	
65 m	31	45,4	18,0	18,0	14,8	11,7	9,2	7,2	5,6	4,2	3,0	

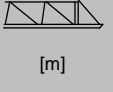
 [m]	2R 24t @ (m)	TD 12t @ (m)	Alcance del gancho [m] / Hook reach [m] / Portée du crochet (m) / Радиус действия крюка (m) / Kancanın yüksekliği (m) / مدى الخطاف									
			20	25	30	35	40	45	50	55	60	
60 m	25,7	39,8	24	24	19	15	11,9	9,5	7,5	5,9	4,5	

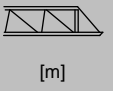
 [m]	2R 30t @ (m)	TD 15t @ (m)	Alcance del gancho [m] / Hook reach [m] / Portée du crochet (m) / Радиус действия крюка (m) / Kancanın yüksekliği (m) / مدى الخطاف									
			15	20	25	30	35	40	45	50	55	
55 m	21,7	35,1	30	30	24,8	19,0	15,1	12	9,6	7,6	6,0	

 Viento fuera de servicio / Out of service wind / Vitesse du vent hors service / Ветровая нагрузка в покое / Rüzgar devre dışı / الريح خارج الخدمة

 Consultar / Consult / Nous consulter / Консультируйтесь / Danışınız / الرجوع إلى

 En servicio / In service / En service / В работе / Devrede / في الخدمة

 Fuera de servicio / Out of service / Hors service / В покое / Devre dışı / خارج الخدمة

Fecha / Date: 30/05/2018

 FEM 1001



Reservado el derecho a modificaciones sin previo aviso. Declinamos toda responsabilidad derivada de la información proporcionada / Subject to modification, without previous warning. This information is supplied without liability / L'entreprise se réserve le droit de procéder à des modifications sans préavis. Nous déclinons toute responsabilité quant aux informations fournies / Мы оставляем за собой право на внесение изменений без предварительного уведомления. Мы снимаем с себя любую ответственность в отношении предоставленной информации / Önceden bildirilmeksizin değiştirilme hakkı saklıdır. Verilen bilgiler için hiçbir sorumluluk kabul etmemekteyiz / حقوق التغيير محفوظة دون إشعار مسبق. دون أدنى مسؤولية عن المعلومات المقدمة

CARACTERÍSTICAS DE MECANISMOS / MECHANISMS FEATURES /
CARACTÉRISTIQUES DES MÉCANISMES / ХАРАКТЕРИСТИКИ МЕХАНИЗМОВ / MEKANİZMALARIN ÖZELLİKLERİ /
J438PA.2R

الخصائص الآلية

*opcional *optional *en option *опция *opsiyonel *اختياري						
	EC150152VF 110 kW	* EC180188VF 132 kW	TG4025VF 4x7,5 kW	OG2008VF 2x7,3 kW	EP10015VF 75 kW	TH4010 29,4 kW
			0...25 m/min	0... 0,8 r/min sl/min	1,5 min	0,6 m/min
			400V 50Hz			
	$H \leq \begin{matrix} \text{TD} & 548\text{m} \\ \text{2R} & 274\text{m} \end{matrix}$	$H \leq \begin{matrix} \text{TD} & 650\text{m} \\ \text{2R} & 325\text{m} \end{matrix}$				
			P_{TOTAL} (EC150152VF + OG2008VF + EP10015VF) = 199,6 kW P_{TOTAL} (*EC180188VF + OG2008VF + EP10015VF) = *221,6 kW			

LISTA DE EMBARQUE / PACKING LIST
J438PA.2R
LISTE DE COLISAGE / СПИСОК ПОСТАВКИ / ÇEKİ LİSTESİ / قائمة التحميل

DENOMINACIÓN / DENOMINATION / DÉSIGNATION / НАЗВАНИЕ / AÇIKLAMA / اسم		L [m]	A [m]	H [m]	P / W [kg]	
Torre inferior / Lower tower / Tour inférieure / Нижняя башня Alt kule البرج السفلي	TSRI-20-5,6		5,990	2,257	2,257	6562
Torre / Tower / Tour Башня / Kule / برج	TSR20 TSR20-5,6		4,260 5,990	2,251 2,257	2,251 2,257	3110 4210
Torre asiento pista, torre superior y orientación Slewling table, top tower and slewing mechanism Tour pivot + tour supérieure + mécanisme d'orientation Сиденье площадки + верхняя башня + поворотный механизм Göbek + üst kule+mekanizma برج وحدة الدوران + البرج العلوي + آلية الدوران			9,650	2,320	2,560	15825
Punta de torre / Top tower / tour supérieure / верхняя башня / Kulenin kafa bölümü / رأس البرج			5,860	2,280	2,380	5300
Torre asiento pista + base punta de torre + orientación Slewling table + tower head base + slewing mechanism Tour pivot + base du porte-flèche + mécanisme d'orientation Сиденье площадки + основание верхней секции башни + поворотный механизм Göbek + üst kule +mekanizma برج وحدة الدوران + البرج العلوي + آلية الدوران			4,660	2,560	2,460	10525

Fecha / Date: 30/05/2018



Reservado el derecho a modificaciones sin previo aviso. Declinamos toda responsabilidad derivada de la información proporcionada / Subject to modification, without previous warning. This information is supplied without liability / L'entreprise se réserve le droit de procéder à des modifications sans préavis. Nous déclinons toute responsabilité quant aux informations fournies / Мы оставляем за собой право на внесение изменений без предварительного уведомления. Мы снимаем с себя любую ответственность в отношении предоставленной информации / Önceden bildirilmeksizin değiştirilme hakkı saklıdır. Verilen bilgiler için hiçbir sorumluluk kabul etmemekteyiz / حقوق التغيير محفوظة دون إشعار مسبق. دون أدنى مسؤولية عن المعلومات المقدمة

LISTA DE EMBARQUE / PACKING LIST

J438PA.2R

قائمة التحميل / ÇEKİ LİSTESİ / СПИСОК ПОСТАВКИ / LISTE DE COLISAGE / اسم

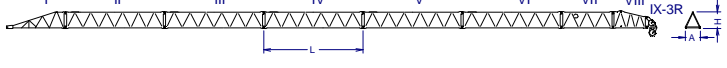
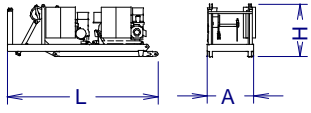
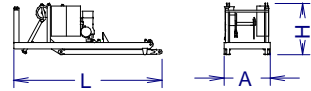
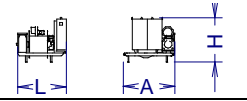
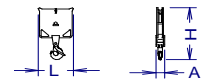
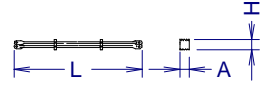
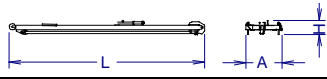
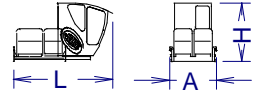
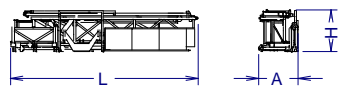
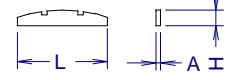
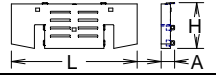
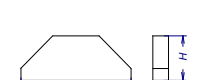
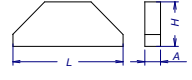
DENOMINACIÓN / DENOMINATION / DÉSIGNATION / НАЗВАНИЕ / AÇIKLAMA / اسم	L [m]	A [m]	H [m]	P / W [kg]		
Tramo de pluma Jib section Tronçon de flèche Секция стрелы Vom bölümü أجزاء الذراع	[I] [II] [III] [IV] [V] [VI] [VII] [VIII] [IX]		6,186 10,460 10,505 10,550 10,550 5,615 3,720 2,010	2,160 1,530 1,530 1,530 1,500 1,500 1,500 1,900	1,760 1,740 1,750 1,750 1,730 1,725 1,725 1,855 2,050	1820 2705 2630 2285 1865 1750 968 975 1025
Contrapluma con mecanismos, pasteca y plumin Counterjib with mechanisms, reeving block and auxiliary jib Contre-flèche avec mécanismes et fléchette auxiliaire Противовесная консоль с механизмами и вспомогательной дополнительной стрелой Mekanizmalı kuiruk ve yardımcı kol uzantısı الذراع المعاكس مع أليات وريشة مساعدة		6,600	2,375	2,765	20550	
Contrapluma con elevacion pluma, pasteca y plumin Counterjib with luffing mechanisms, reeving block and auxiliary jib Contre-flèche avec mécanisme de relevage de la flèche, moufle et fléchette Противовесная консоль с механизмом подъема стрелы, блоком и дополнительной стрелой Kaldırma kollu, makara düzenekli ve kol uzantılı kuiruk الذراع المعاكس مع رافع الذراع والبكرة والريشة الإضافية		6,600	2,200	2,555	11860	
Mecanismo elevacion carga / Hoisting mechanism / Mécanisme de levage de charge / Подъем груза / Yük kaldırma / رافع الحمولة		2,650	2,470	2,170	8690	
Polipasto / Hook assembly / TD/2R Palan / Полуспаст / Kanca takımı / بكرة TD		1,010 0,180	0,414 0,3458	1,985 2,090	785 380	
Tirante sostén pluma / Jib support tie / Tirant de fleche Растяжка поддержки стрелы / Kol destek bağları مشد دعامة الذراع		5,850	0,430	0,615	2375	
Parte superior Top part		11,950	2,247	1,702	6840	
Plataforma y cabina (2 x 1,5) / Platform and cabin Plateforme et cabine / Платформа и кабина / Platform ve kabin / منصة وكابينة		3,670	1,925	2,480	1130	
Transporte torre de montaje / Jacking cage transport / Transport de tour de montage / Транспортировка монтажной башни / Kaldırma kafesinin taşınması / نقل برج التركيب	TM20PASR-5,6 	10,820	2,285	2,395	12140	
Contrapeso / Counterweight Contrepoids / Противовес / Denge ağırlığı / اوزان معاكسة		4,500	0,340	0,830	6000	
		2,200	0,340	0,830	3000	
		3200	0,340	1,150	6000	
Contrapeso / Counterweight / Contrepoids / Противовес / Denge ağırlığı / اوزان معاكسة	Lastre / Ballast / Lest / Балласт Alt ağırlık taşları / نقل 	3,8	0,58	1,5	6000	

Fecha / Date: 30/05/2018

 **FEM 1001**



Reservado el derecho a modificaciones sin previo aviso. Declinamos toda responsabilidad derivada de la información proporcionada / Subject to modification, without previous warning. This information is supplied without liability / L'entreprise se réserve le droit de procéder à des modifications sans préavis. Nous déclinons toute responsabilité quant aux informations fournies / Мы оставляем за собой право на внесение изменений без предварительного уведомления. Мы снимаем с себя любую ответственность в отношении предоставленной информации / Önceden bildirilmeksizin değiştirilme hakkı saklıdır. Verilen bilgiler için hiçbir sorumluluk kabul etmemekteyiz / حقوق التغيير محفوظة دون إشعار مسبق. دون أدنى مسؤولية عن المعلومات المقدمة

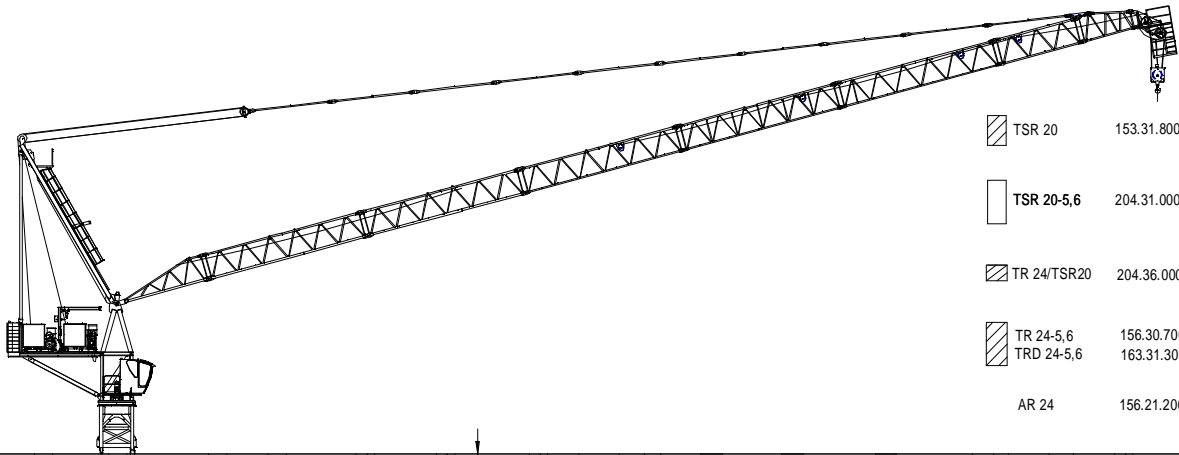

	TSR 20	153.31.800
	TSR 20-5,6	204.31.000
	TR 24/TSR20	204.36.000
	TR 24-5,6	156.30.700
	TRD 24-5,6	163.31.300
	AR 24	156.21.200

T H														H T				
1	5,9																4,2	1
2	11,5																9,8	2
3	17,1																15,4	3
4	22,7																21	4
5	28,3																26,6	5
6	33,9																32,2	6
7	40,9																39,5	7
8	46,5																46,5	8
9	52,1																52,1	9
10	57,7																57,7	10
11	63,3																63,3	11
12	68,9																68,9	12

T: Torre / Tower / Tour / Башни / Kuleler / أبراج
 H: Altura / Height / Hauteur / Высота / Yükseklik / ارتفاع

Otras configuraciones de torre / Other tower configuration / Autres configurations / Прочие конфигурации / Diğer konfigürasyonlar / مكونات أخرى

TRANSPORTE / TRANSPORT / TRANSPORT / ТРАНСПОРТИРОВКА / TAŞIMA / نقل J438PA.2R

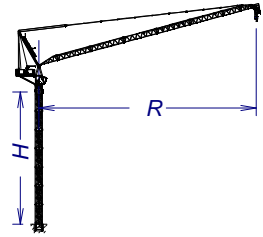

7 x	HIGH CUBE 40'
1 x	OPEN TOP 40'

R = 65 m, H = 33,9 m + + ASRD20/24



Ctra./Rd. Madrid - Irún Km. 415 - 20.213 IDIAZABAL [Gipuzkoa] ESPAÑA / SPAIN
 P.O. Box, 23 - 20.200 BEASAIN - E-mail: jaso@jaso.com
 Tel. +34 943 - 18 70 00 • Fax. +34 943 - 18 70 20
www.jaso.com

Fecha / Date: 30/05/2018

FEM 1001

DELEGACION / DEALER

Reservado el derecho a modificaciones sin previo aviso. Declinamos toda responsabilidad derivada de la información proporcionada / Subject to modification, without previous warning. This information is supplied without liability / L'entreprise se réserve le droit de procéder à des modifications sans préavis. Nous déclinons toute responsabilité quant aux informations fournies / Мы оставляем за собой право на внесение изменений без предварительного уведомления. Мы снимаем с себя любую ответственность в отношении предоставленной информации / Önceden bildirilmeksizin değiştirilme hakkı saklıdır. Verilen bilgiler için hiçbir sorumluluk kabul etmemekteyiz /

حقوق التغيير محفوظة دون إشعار مسبق. دون أدنى مسؤولية عن المعلومات المقدمة