

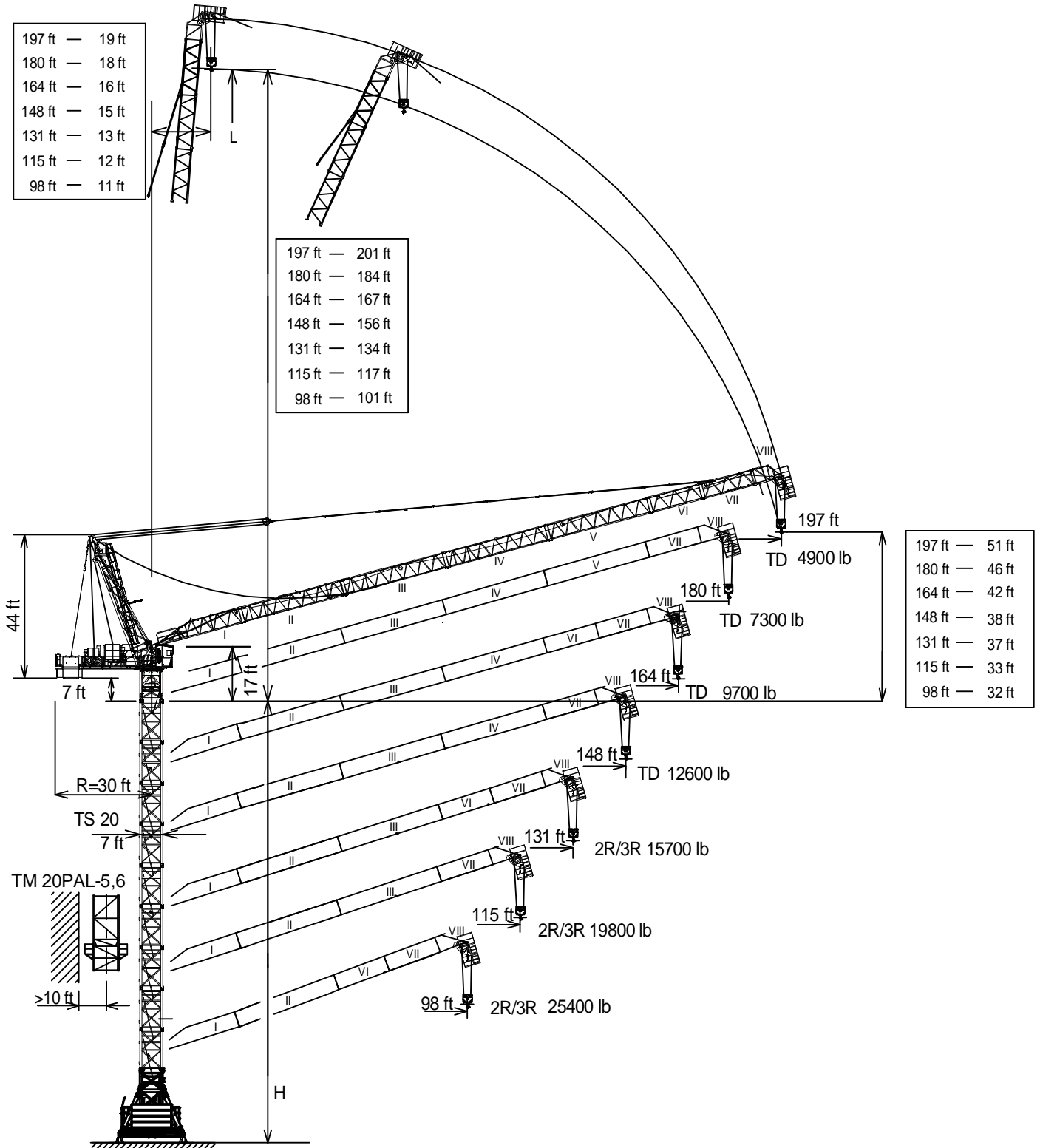

EN 14439
C25

UNE-EN-ISO 9001



(H) TRASLACIÓN / TRAVELLING

(H) ESTACIONARIA / STATIONARY

164 ▽ 98

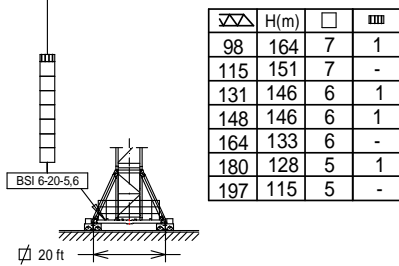

185 ▽ 98

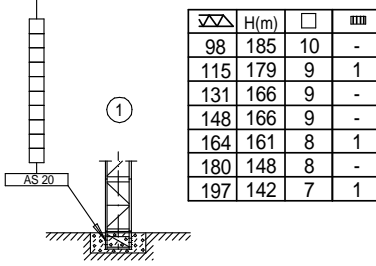

163 ▽ 98

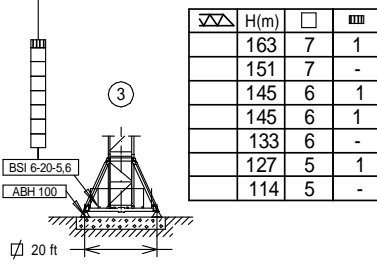

- ▨ TS 20
- TS 20-5,6
- ▨ TSR 20-5,6A
- ⊗ TSR 20-5,6

188 ▽ 98

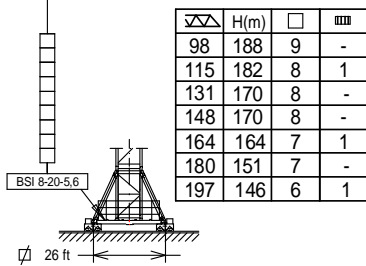

216 ▽ 98

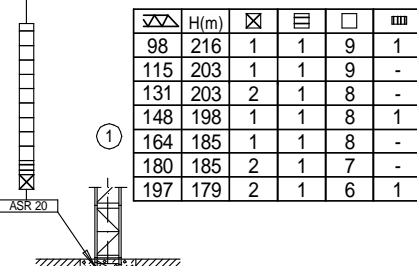

188 ▽ 98

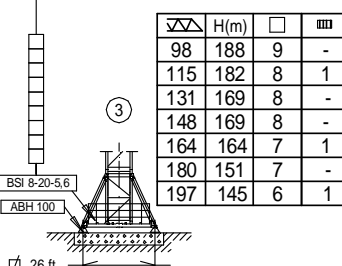

TREPADO / CLIMBING

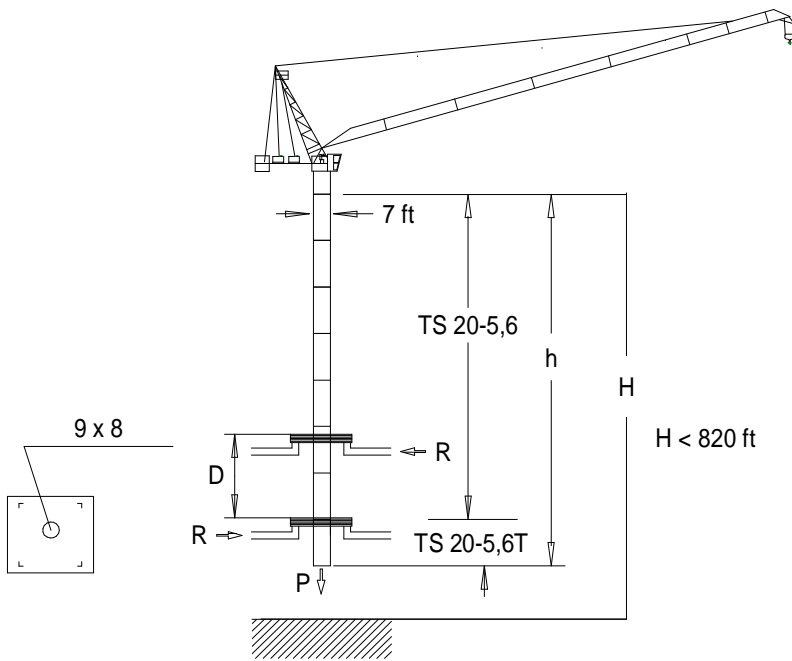

$h_{max} = TS\ 20-5,6T + 5 \times TS\ 20-5,6$

h (ft)	111
D (ft)	50 - 56
P (lbf)	238700 211800
Rmax (lbf)	56900 97800

TS20-5,6T: 160.32.600

i Trepado interno / Internal climbing

🚫 Viento fuera de servicio / Out of service wind

i Consultar / Consult

▶ En servicio / In service



■ Fuera de servicio / Out of service



Fecha / Date: 08/02/2017

FEM 1005 - C25





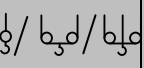
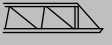







Reservado el derecho a modificaciones sin previo aviso. Declinamos toda responsabilidad derivada de la información proporcionada / Subject to modification, without previous warning. This information is supplied without liability

 TD [lb]	TD 13200 lb @ (ft)	Cargas máximas / Maximum loads TD – 13200 lb							
		Alcance del gancho [ft] / Hook reach [ft]							
		82	98	115	131	148	164	180	197
197 ft	136	13200	13200	13200	13200	11200	8600	6600	4900
180 ft	140	13200	13200	13200	13200	11900	9500	7300	—
164 ft	142	13200	13200	13200	13200	12100	9700	—	—
148 ft	144	13200	13200	13200	13200	12600	—	—	—
131 ft	131	13200	13200	13200	13200	—	—	—	—
115 ft	115	13200	13200	13200	—	—	—	—	—
98 ft	98	13200	13200	—	—	—	—	—	—

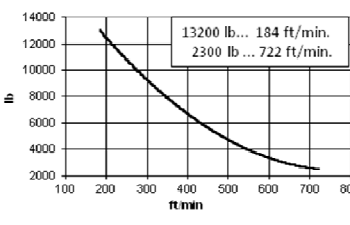
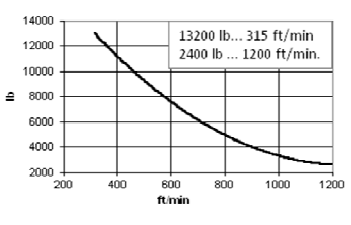
 TD/2R/3R (lb)	3R 39700 lb @...[ft]	2R 26500 lb @...[ft]	TD 13200 lb @...[ft]	Cargas máximas / Maximum loads TD/2R/3R – 13200 / 26500 / 39700 lb								
				Alcance del gancho [ft] / Hook reach [ft]								
				66	82	98	115	131	148	164	180	197
197 ft		90	135	26500	26500	23100	17900	13900	10800	8400	6200	4400
180 ft		92	138	26500	26500	23600	18500	14600	11500	9000	6800	—
164 ft	69	92	140	39700	31300	24000	18700	15000	11900	9300	—	—
148 ft	69	93	141	39700	31300	24300	19200	15200	12100	—	—	—
131 ft	69	94	131	39700	31800	24700	19600	15700	—	—	—	—
115 ft	69	94	115	39700	32000	24900	19800	—	—	—	—	—
98 ft	70	95	98	39700	32400	25400	—	—	—	—	—	—

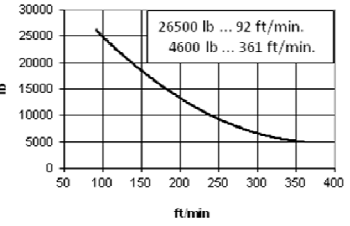
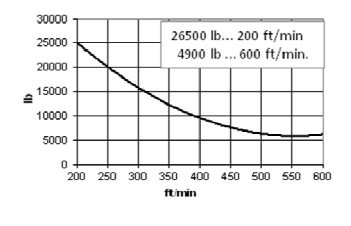
CARACTERISTICAS DE MECANISMOS / MECHANISMS FEATURES

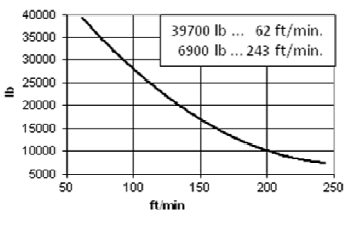
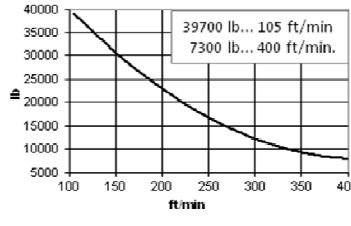
J265PA

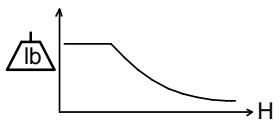
<p>*opcional *optional</p>						
	<p>EC88110VF 65 kW</p>	<p>*EC150185VF 110 kW</p>	<p>TG2020VF 2x7,3 kW</p>	<p>OG1507VF 2x5,5 kW</p>	<p>EP6015VF 44,1 kW</p>	<p>TH2006 15 kW</p>
			<p>0...66 ft/min</p>	<p>0...0,8 r/min sl/min</p>	<p>1,5 min</p>	<p>2 ft/min</p>
			 480V 60Hz EC88110VF: AMPERAGE = 203 A EC150185VF: AMPERAGE = 263 A			
			 <p>H ≤ TD 2067 ft 2R 1033 ft 3R 689 ft</p> <div style="display: flex; align-items: center;">   </div>			



Fecha / Date: **08/02/2017**

 **FEM 1005 - C25**

Reservado el derecho a modificaciones sin previo aviso. Declinamos toda responsabilidad derivada de la información proporcionada / Subject to modification, without previous warning. This information is supplied without liability

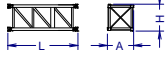
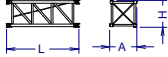
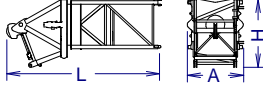
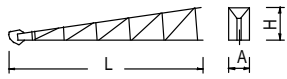
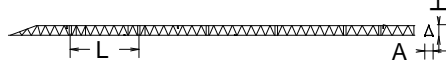
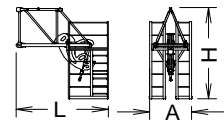
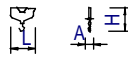
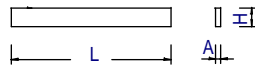
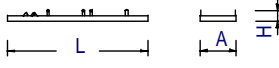
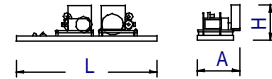
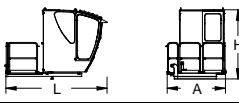
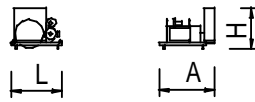
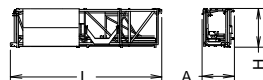
DENOMINACIÓN / DENOMINATION		L [ft]	A [ft]	H [ft]	P / W [lb]	
Torre inferior <i>Lower tower</i>	TSI20-5,6		19.6	7.6	7.8	11880
Torre <i>Tower</i>	TS20		13.9	7.7	7.7	5900
	TS20-5,6		19.6	7.6	7.8	7950
	TSR20-5,6A		19.4	7.8	7.6	8020
	TSR20-5,6		19.7	7.4	7.4	9400
	TR24-5,6		19.7	9.1	9.3	10200
Torre asiento pista + base punta de torre + orientación <i>Slewing table + tower head base + slewing mechanism</i>			19.4	8.8	101.2	22500
Punta de torre + pasteca <i>Tower head +reeving block</i>			38.3	6.3	6.7	13200
Tramo de pluma <i>Jib section</i>	(I)		30.3	6.9	5.8	3500
	(II)		33.5	4.2	5.3	3300
	(III)		33.5	4.2	5.2	3000
	(IV)		33.5	4.2	5.2	2700
	(V)		33.5	4.2	5.2	2600
	(VI)		17.4	4.2	5.2	1500
	(VII)		17.4	4.2	5.3	2000
Punta de pluma <i>Jib end</i>			11.2	5.2	11.8	1940
Polipasto <i>Hook assembly</i>			3.0	1.3	4.0	970
Tirante sostén pluma <i>Jib support tie</i>			19.2	1.2	1.2	2500
Estructura contrapluma <i>Counterjib structure</i>			25.5	6.3	2.4	3200
Contrapluma con mecanismos <i>Counterjib with mechanisms</i>			25.5	7.3	7.8	26000
Plataforma y cabina <i>Platform and cabin</i>			11.2	6.8	7.9	2400
Mecanismos <i>Mechanisms</i>	Elevación carga / <i>Hoisting /</i>		7.9	6.8	6.8	13700
	Elevación pluma / <i>Luffing</i>		6.5	7.7	6.2	7100
Transporte torre de montaje <i>Jacking cage transport</i>	TM 20PAL-5,6		31.3	6.8	8.3	12500

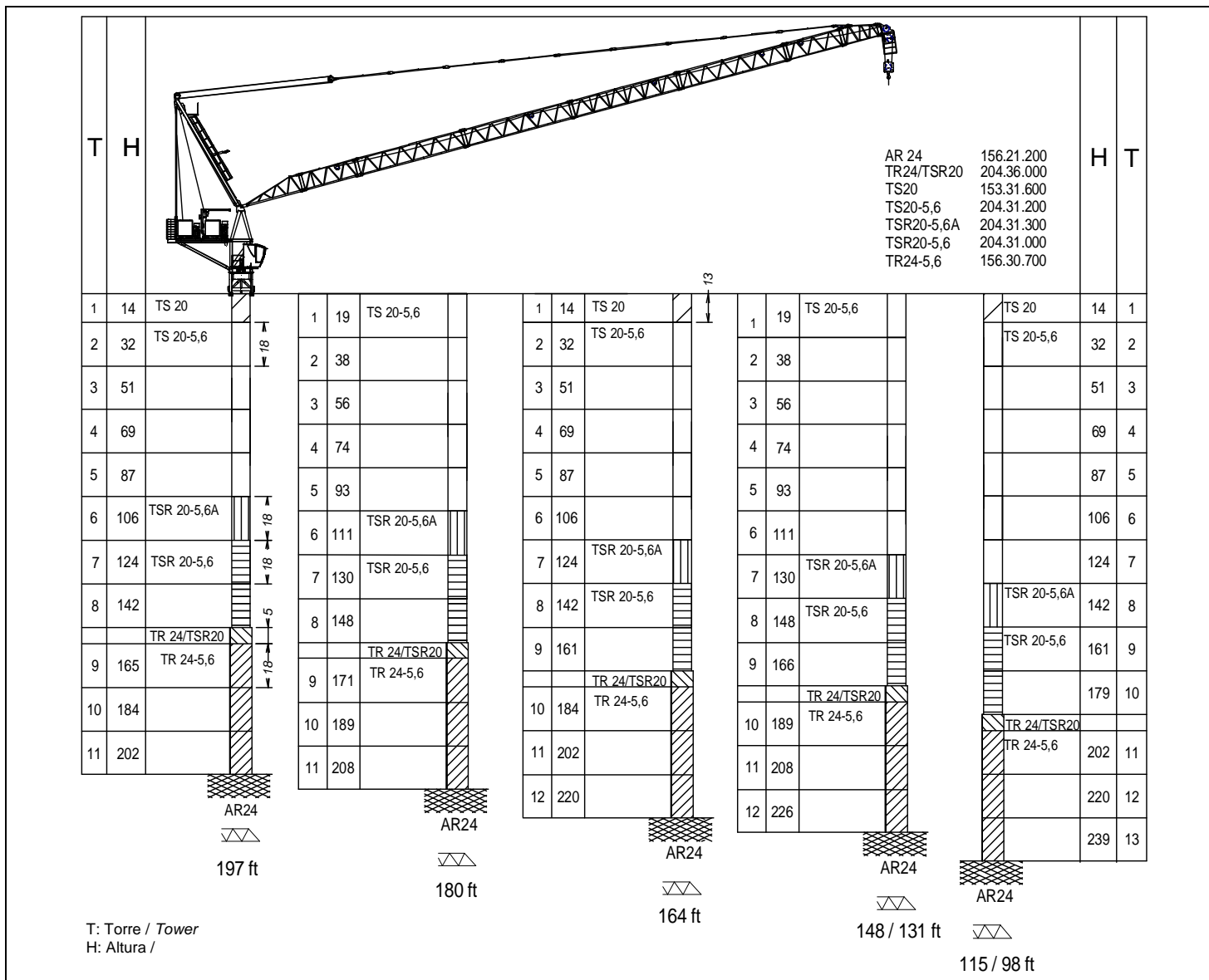

i Otras configuraciones de torre / Other tower configuration

TREPADO / CLIMBING

J265PA

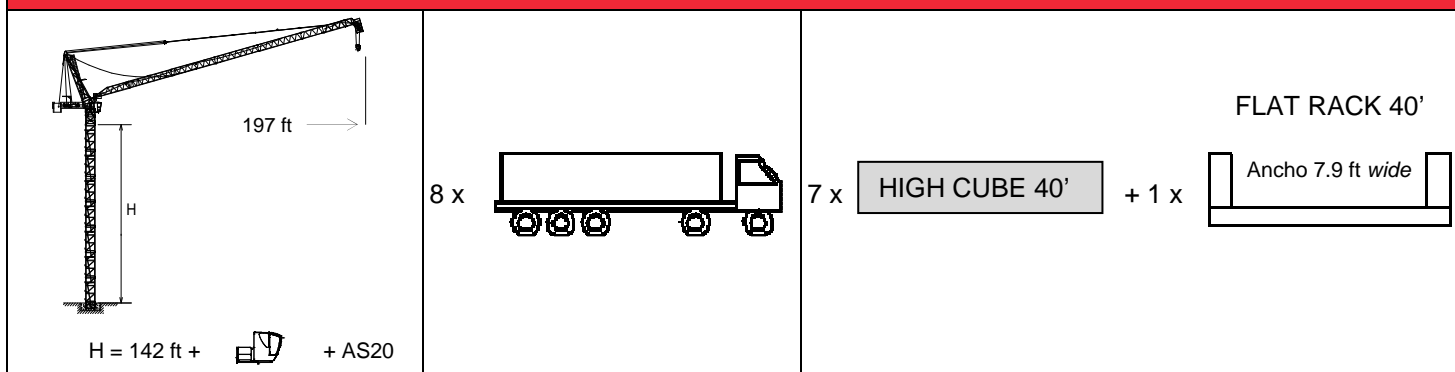

Ctra./Rd. Madrid - Irún Km. 415 - 20.213 IDIAZABAL [Gipuzkoa] ESPAÑA / SPAIN
 P.O. Box, 23 - 20.200 BEASAIN - E-mail: jaso@jaso.com
 Tel. +34 943 - 18 70 00 • Fax. +34 943 - 18 70 20
www.jaso.com

Fecha / Date: 08/02/2017

FEM 1005 - C25

DELEGACION / DEALER