

# GRUA TORRE / TOWER CRANE

GRUE A TOUR / БАШЕННЫЙ КРАН /

KULE VINÇ / رافعة برجية

# J780PA



EN 14439  
C25

UNE-EN-ISO 9001

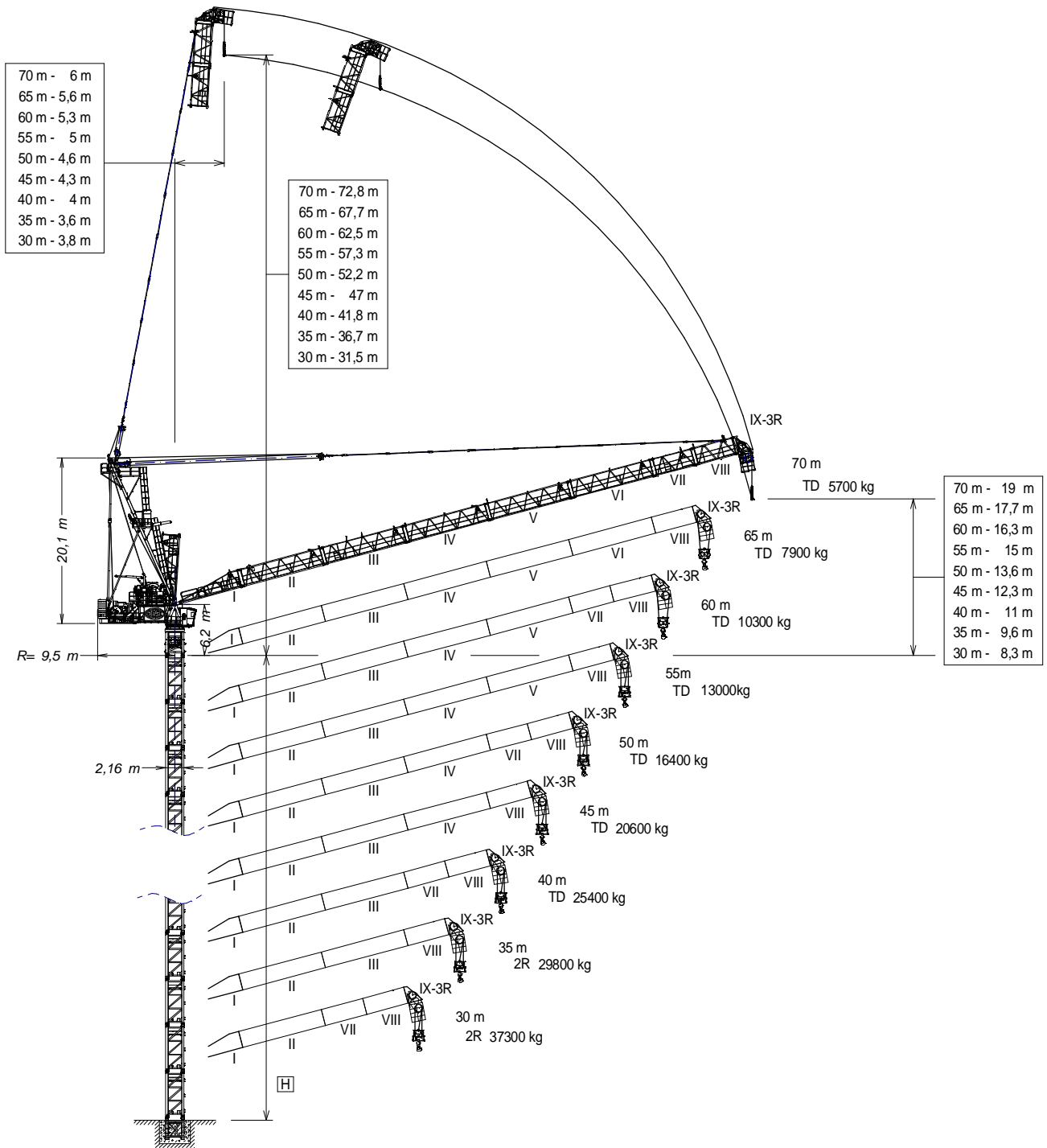

H = Máxima altura de torre sin arriostrar (m).  
Maximum tower height without fastening (m).  
Hauteur maximale de tour sans ancrage (m).  
Максимальная высота башни без крепления (м).  
Desteksiz maksimum kule yüksekliği (m).  
أقصى ارتفاع للبرج بدون ربط (م)

\* Tramo pluma / Jib section / Tronçon de flèche /  
Секция стрелы / Бор bölümü / أجزاء النراع

\*Tramo pluma I / Jib setion I -----214.40.000  
\*Tramo pluma II / Jib setion II -----214.41.000  
\*Tramo pluma III / Jib setion III -----214.42.000  
\*Tramo pluma IV / Jib setion IV -----214.43.000  
\*Tramo pluma V / Jib setion V -----214.44.000  
\*Tramo pluma VI / Jib setion VI -----214.45.000  
\*Tramo pluma VII / Jib setion VII -----214.46.000  
\*Tramo pluma VIII / Jib setion VIII -----214.47.000  
\*Tramo pluma IX / Jib setion IX -----214.48.000

ASP20 -----212.21.200  
TSP20 -----212.32.400  
TSP20-5,6 -----212.31.000  
TSP24-5,6 -----212.32.000  
TSP24/TSP20 -----212.36.000

Fecha / Date: 31/05/2018

FEM 1005 - C25



Reservado el derecho a modificaciones sin previo aviso. Declinamos toda responsabilidad derivada de la información proporcionada / Subject to modification, without previous warning. This information is supplied without liability / L'entreprise se réserve le droit de procéder à des modifications sans préavis. Nous déclinons toute responsabilité quant aux informations fournies / Мы оставляем за собой право на внесение изменений без предварительного уведомления. Мы снимаем с себя любую ответственность в отношении предоставленной информации / Önceden bildirilmeksizin değiştirilme hakkı saklıdır. Verilen bilgiler için hiçbir sorumluluk kabul etmemekteyiz / حقوق التغيير محفوظة دون إشعار مسبق. دون أدنى مسؤولية عن المعلومات المقدمة

TD

(H) ESTACIONARIA / STATIONARY /  
STATIONAIRE / СТАЦИОНАРНОЕ СОСТОЯНИЕ / SABIT / ثابتة

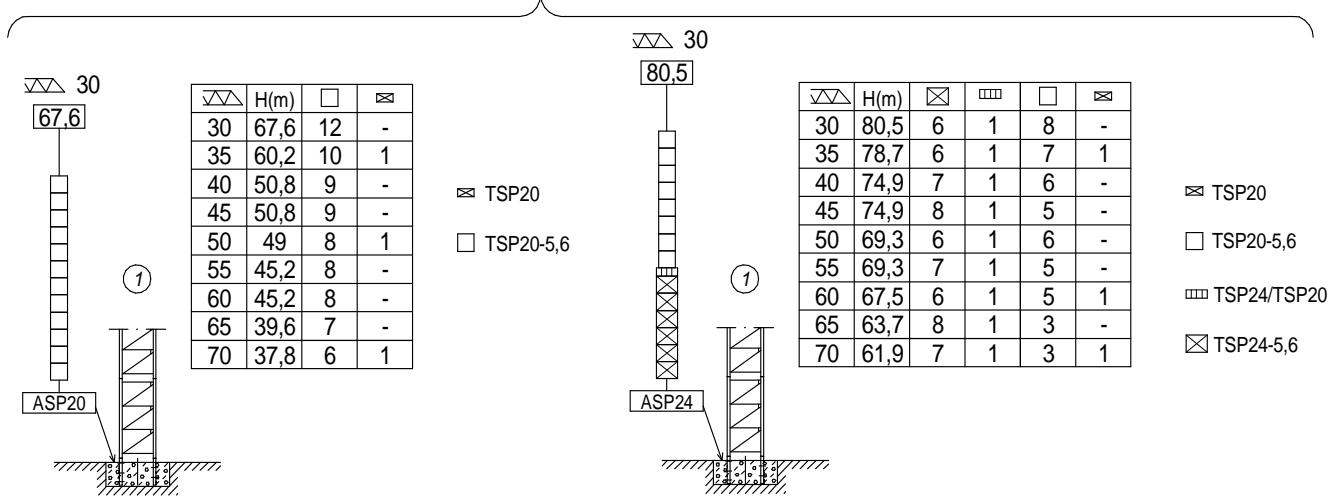

2R

(H) ESTACIONARIA / STATIONARY /  
STATIONAIRE / СТАЦИОНАРНОЕ СОСТОЯНИЕ / SABIT / ثابتة

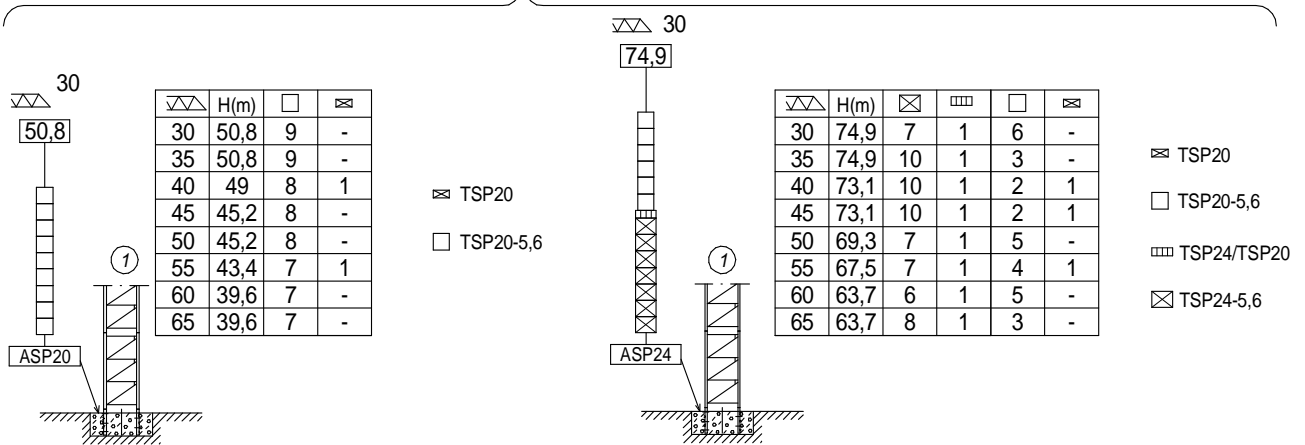

3R

(H) ESTACIONARIA / STATIONARY /  
STATIONAIRE / СТАЦИОНАРНОЕ СОСТОЯНИЕ / SABIT / ثابتة

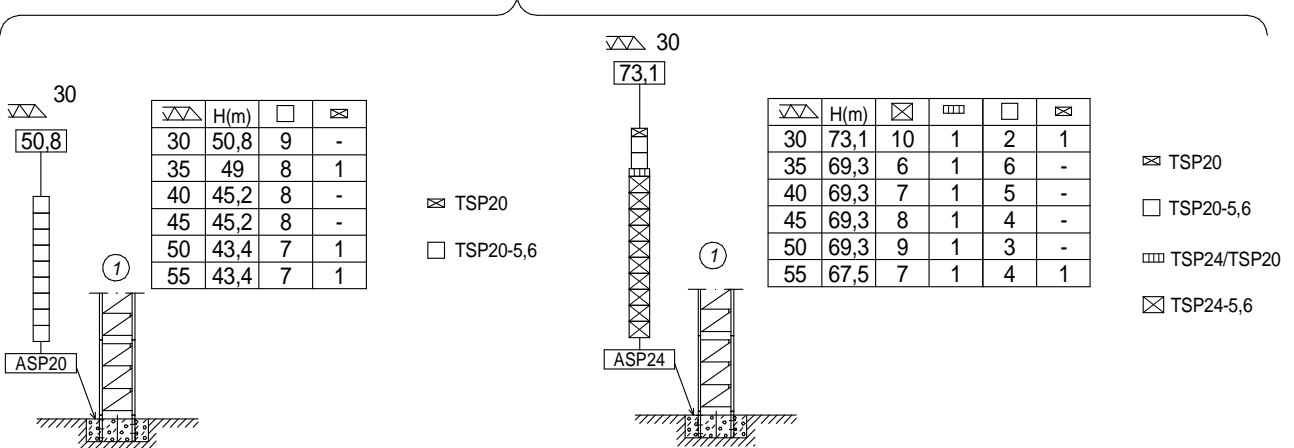





Fecha / Date: 31/05/2018



FEM 1005 – C25















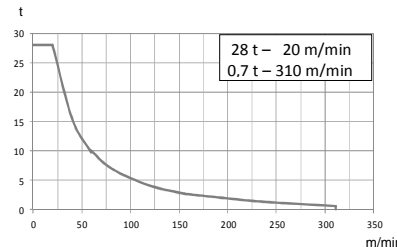
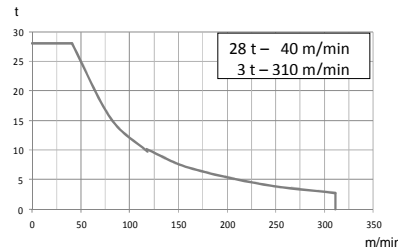

Reservado el derecho a modificaciones sin previo aviso. Declinamos toda responsabilidad derivada de la información proporcionada / Subject to modification, without previous warning. This information is supplied without liability / L'entreprise se réserve le droit de procéder à des modifications sans préavis. Nous déclinons toute responsabilité quant aux informations fournies / Мы оставляем за собой право на внесение изменений без предварительного уведомления. Мы снимаем с себя любую ответственность в отношении предоставленной информации / Önceden bildirimlemeden değiştirilme hakkı saklıdır. Verilen bilgiler için hiçbir sorumluluk kabul etmemekteyiz. حقوق التغيير محفوظة دون إشعار مسبق. دون أدنى مسؤولية عن المعلومات المقدمة

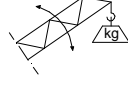
 TD (t)		Cargas máximas / Maximum loads / Charges maximales / Максимальные нагрузки / Maksimum yük / أقصى حمولة TD-28t									
 [m]	TD 28t @ (m)	Alcance del gancho [m] / Hook reach [m] / Portée du crochet (m) / Радиус действия крюка (m) / Kancanın yüksekliği (m) / مدى الخطاف									
		25	30	35	40	45	50	55	60	65	70
70 m	37,0	28,0	28,0	28,0	24,5	19,6	15,7	12,5	9,9	7,6	5,7
65 m	37,0	28,0	28,0	28,0	24,5	19,7	15,9	12,7	10,1	7,9	-
60 m	37,0	28,0	28,0	28,0	24,5	19,8	16,0	12,9	10,3	-	-
55 m	37,0	28,0	28,0	28,0	24,6	19,9	16,1	13,0	-	-	-
50 m	37,2	28,0	28,0	28,0	24,8	20,1	16,4	-	-	-	-
45 m	37,6	28,0	28,0	28,0	25,3	20,6	-	-	-	-	-
40 m	37,7	28,0	28,0	28,0	25,4	-	-	-	-	-	-
35 m	35,0	28,0	28,0	28,0	-	-	-	-	-	-	-
30 m	30,0	28,0	28,0	-	-	-	-	-	-	-	-

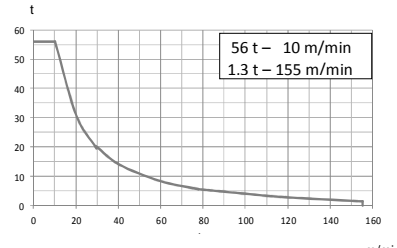
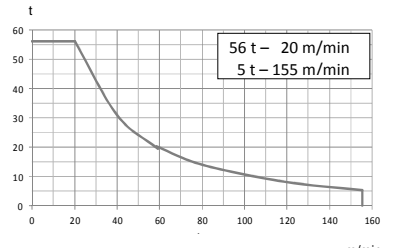
 2R (t)			Cargas máximas / Maximum loads / Charges maximales / Максимальные нагрузки / Maksimum yük / أقصى حمولة 2R (t)									
 [m]	2R max (t)	@ (m)	Alcance del gancho [m] / Hook reach [m] / Portée du crochet (m) / Радиус действия крюка (m) / Kancanın yüksekliği (m) / مدى الخطاف									
			20	25	30	35	40	45	50	55	60	65
65 m	42,0	27,0	42,0	42,0	35,9	28,1	22,3	17,7	14,1	11,1	8,6	6,5
60 m	56,0	21,9	56,0	46,8	36,0	28,2	22,4	17,9	14,3	11,4	8,9	-
55 m	56,0	21,9	56,0	46,9	36,1	28,4	22,6	18,1	14,5	11,6	-	-
50 m	56,0	21,9	56,0	47,0	36,3	28,7	23,0	18,6	15,0	-	-	-
45 m	56,0	22,0	56,0	47,4	36,8	29,3	23,6	19,2	-	-	-	-
40 m	56,0	22,0	56,0	47,5	37,0	29,6	24,0	-	-	-	-	-
35 m	56,0	22,0	56,0	47,5	37,2	29,8	-	-	-	-	-	-
30 m	56,0	22,0	56,0	47,6	37,3	-	-	-	-	-	-	-

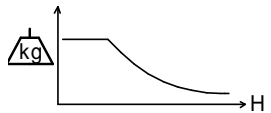
 3R (t)			Cargas máximas / Maximum loads / Charges maximales / Максимальные нагрузки / Maksimum yük / أقصى حمولة 3R (t)									
 [m]	3R max (t)	@ (m)	Alcance del gancho [m] / Hook reach [m] / Portée du crochet (m) / Радиус действия крюка (m) / Kancanın yüksekliği (m) / مدى الخطاف									
			15	20	25	30	35	40	45	50	55	
55 m	65,0	18,9	65,0	60,4	44,7	34,2	26,7	21,0	16,7	13,2	10,3	
50 m	70,0	17,8	70,0	60,4	44,8	34,4	27,0	21,5	17,2	13,7	-	
45 m	75,0	16,8	75,0	60,4	45,1	34,9	27,6	22,2	17,9	-	-	
40 m	75,0	16,8	75,0	60,6	45,4	35,3	28,1	22,7	-	-	-	
35 m	75,0	16,8	75,0	60,7	45,7	35,7	28,5	-	-	-	-	
30 m	75,0	16,8	75,0	60,8	45,9	36,0	-	-	-	-	-	

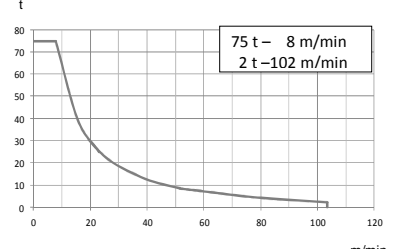
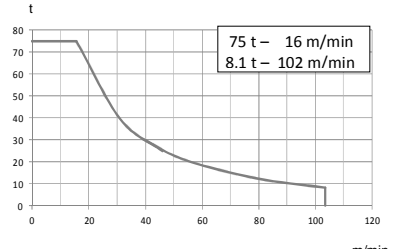

				
<b>EC300310VF</b>				
<b>110 kW</b>		<b>220 kW</b>		<b>OG4007VF 2x15 kW</b>
	 <p style="text-align: center;">28 t – 20 m/min 0,7 t – 310 m/min</p>	 <p style="text-align: center;">28 t – 40 m/min 3 t – 310 m/min</p>	<p>0... 0,7 r/min sl/min</p>	 1,6... 2,4 min   1,8... 2,8 min
	 <p style="text-align: center;">56 t – 10 m/min 1,3 t – 155 m/min</p>	 <p style="text-align: center;">56 t – 20 m/min 5 t – 155 m/min</p>	<p><b>400V 50Hz</b></p> <p><b>PTOTAL(EC300310VF(110) + OG4007VF + EP15020VF) = 250 kW</b>  <b>PTOTAL(EC300310VF(220) + OG4007VF + EP15020VF) = 360 kW</b></p>	
				
	 <p style="text-align: center;">75 t – 8 m/min 2 t – 102 m/min</p>	 <p style="text-align: center;">75 t – 16 m/min 8.1 t – 102 m/min</p>	 <p style="margin-left: 20px;">                 TD      1007m                  H ≤ 2R    504m                        3R    336m             </p>	



Fecha / Date: 31/05/2018

 **FEM 1005 – C25**

Reservado el derecho a modificaciones sin previo aviso. Declinamos toda responsabilidad derivada de la información proporcionada / Subject to modification, without previous warning. This information is supplied without liability / L'entreprise se réserve le droit de procéder à des modifications sans préavis. Nous déclinons toute responsabilité quant aux informations fournies / Мы оставляем за собой право на внесение изменений без предварительного уведомления. Мы снимаем с себя любую ответственность в отношении предоставленной информации / Önceden bildirilmeksizin değiştirilme hakkı saklıdır. Verilen bilgiler için hiçbir sorumluluk kabul etmemekteyiz / حقوق التغيير محفوظة دون إشعار مسبق. دون أدنى مسؤولية عن المعلومات المقدمة

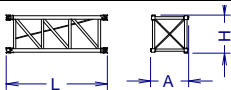
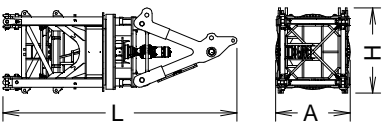
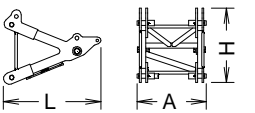
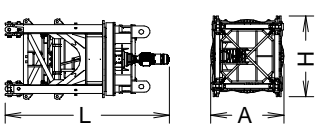
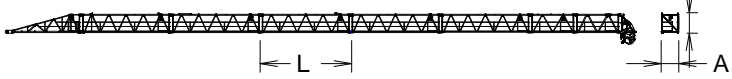
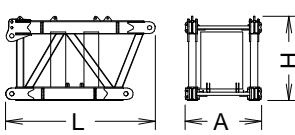
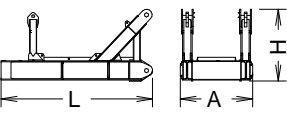
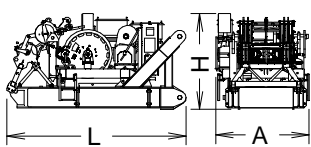
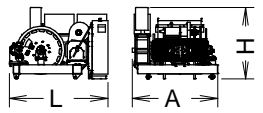
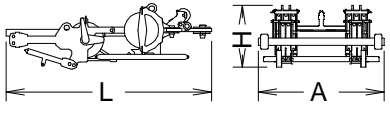
DENOMINACIÓN / DENOMINATION / DÉSIGNATION / НАЗВАНИЕ / AÇIKLAMA / اسم		L [m]	A [m]	H [m]	P / W [kg]	
Torre / Tower / Tour Башня / Kule / برج	TSP20 TSP20-5,6 TSP24-5,6		4,374 6,164 6,164	2,285 2,285 2,754	2,383 2,383 2,852	5615 7665 8295
Torre asiento pista, torre superior y orientación Slewing table, top tower and slewing mechanism Tour pivot + tour supérieure + mécanisme d'orientation Сиденье площадки + верхняя башня + поворотный механизм Göbek + üst kule + mekanizma برج وحدة الدوران + البرج العلوي + آلية الدوران			7,245	2,315	2,625	25540
Punta de torre / Top tower / tour supérieure / верхняя башня / Kulenin kafa bölümü / رأس البرج			3,200	2,275	2,435	5895
Torre asiento pista + base punta de torre + orientación Slewing table + tower head base + slewing mechanism Tour pivot + base du porte-flèche + mécanisme d'orientation Сиденье площадки + основание верхней секции башни + поворотный механизм Göbek + üst kule + mekanizma برج وحدة الدوران + البرج العلوي + آلية الدوران			5,200	2,315	2,545	19645
Tramo de pluma Jib section Tronçon de flèche Секция стрелы Вот bölümü أجزاء الذراع	[I] [II] [III] [IV] [V] [VI] [VII] [VIII] [IX-3R]		8,884 10,583 10,583 10,583 10,583 10,583 5,406 5,396 1,997	2,271 2,150 1,988 1,988 1,988 1,988 1,988 1,988 2,032	2,259 2,369 2,277 2,404 2,277 2,258 2,270 2,279 3,610	3940 4315 3710 3220 3290 2880 1815 2305 3030
Contrapluma 1 Counterjib 1 Contre-flèche 1 Противовесная консоль 1 Куурук 1 الذراع المعاكس 1			4,471	2,290	2,540	9915
Contrapluma 2 Counterjib 2 Contre-flèche 2 Противовесная консоль 2 Куурук 2 الذراع المعاكس 2			4,793	2,290	2,250	8065
Contrapluma 2 + Elevación pluma + pasteca Counterjib 2 + Luffing mech + Reeving block Contre-flèche 2 + Relevage de flèche + Bloc de renvoi Противовесная консоль 2 + Подъем стрелы + Канифас-болк Куурук 2 + Yük kaldırma ve indirme + Masa الذراع المعاكس 2 + رافع الذراع			5,085	2,665	2,725	19250
Elevación pluma / Luffing mech / Relevage de flèche / Подъем стрелы / Yük kaldırma ve indirme			2,860	2,480	2,075	8510
Pasteca, Reeving Block, Bloc de renvoi + Канифас-болк + Masa			3,340	1,055	2,050	1875



Fecha / Date: 31/05/2018

Reservado el derecho a modificaciones sin previo aviso. Declinamos toda responsabilidad derivada de la información proporcionada / Subject to modification, without previous warning. This information is supplied without liability / L'entreprise se réserve le droit de procéder à des modifications sans préavis. Nous déclinons toute responsabilité quant aux informations fournies / Мы оставляем за собой право на внесение изменений без предварительного уведомления. Мы снимаем с себя любую ответственность в отношении предоставленной информации / Önceden bildirilmeksizin değiştirilme hakkı saklıdır. Verilen bilgiler için hiçbir sorumluluk kabul etmemekteyiz / حقوق التغيير محفوظة دون إشعار مسبق. دون أدنى مسؤولية عن المعلومات المقدمة

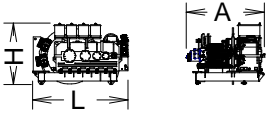
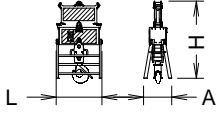
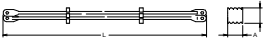
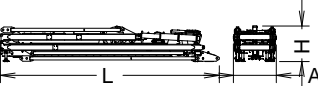
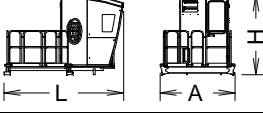
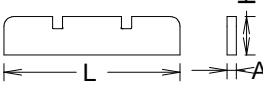
DENOMINACIÓN / DENOMINATION / DÉSIGNATION / НАЗВАНИЕ / AÇIKLAMA / اسم		L [m]	A [m]	H [m]	P / W [kg]	
Mecanismo elevacion carga sin cable / Hoisting mechanism without rope / Mécanisme de levage de charge sans câble / Подъем груза (without rope) / Yük kaldırma (without rope) / رافع الحمولة (without rope)		3,805	3,110	2,515	20305	
Polipasto / Hook assembly / Palan / Полупаст / Kanca takımı / بكرة	TD/2R/3R TD		1,512 0,570	0,950 0,385	2,540 1,745	2030 675
Tirante sostén pluma / Jib support tie / Tirant de fleche / Растяжка поддержки стрелы / Kol destek bağları / مشد دعامة الذراع		5,416 5,416	0,360 0,360	0,400 0,400	1390 1375	
Parte superior + mecanismo auxiliar / Top part + auxiliary winch		11,825	2,300	1,978	17800	
Plataforma y cabina (2 x 1,5) / Platform and cabin / Plateforme et cabine / Платформа и кабина / Platform ve kabin / منصة وكابينة		3,670	2,300	2,480	1250	
Contrapeso / Counterweight / Contrepoids / Противовес / Denge ağırlığı / اوزان معاكسة		4,500 2,320	0,235 0,235	1,005 1,005	8000 4000	



Ctra./Rd. Madrid - Irún Km. 415 - 20.213 IDIAZABAL [Gipuzkoa] ESPAÑA / SPAIN  
 P.O. Box, 23 - 20.200 BEASAIN - E-mail: jaso@jaso.com  
 Tel. +34 943 - 18 70 00 • Fax. +34 943 - 18 70 20  
**www.jaso.com**

Fecha / Date: 31/05/2018

 **FEM 1005 – C25**

DELEGACION / DEALER

Reservado el derecho a modificaciones sin previo aviso. Declinamos toda responsabilidad derivada de la información proporcionada / Subject to modification, without previous warning. This information is supplied without liability / L'entreprise se réserve le droit de procéder à des modifications sans préavis. Nous déclinons toute responsabilité quant aux informations fournies / Мы оставляем за собой право на внесение изменений без предварительного уведомления. Мы снимаем с себя любую ответственность в отношении предоставленной информации / Önceden bildirilmeksizin değiştirilme hakkı saklıdır. Verilen bilgiler için hiçbir sorumluluk kabul etmemekteyiz /

حقوق التغيير محفوظة دون إشعار مسبق. دون أدنى مسؤولية عن المعلومات المقدمة